

PROFESSIONAL BOOK

-PRODUCTS FOR CERAMIC INSTALLATION-



BY APPOINTMENT TO
H.R.H. THE PRINCE OF WALES
MANUFACTURER AND DISTRIBUTOR
OF CERAMIC TILES AND BUILDING PRODUCTS.
PORCELANOSA GROUP LIMITED

butech.
PORCELANOSA Grupo



This catalogue is protected under the Spanish Intellectual Property Act (Royal Decree 1/1996).
Any reproduction of its contents, in whole or in part, without the express consent of PORCELANOSA Grupo
will be subject to punitive action under the Spanish Criminal Code.



ÍN DEX

- 5 Decorative and technical profiles
- 73 Tile installation adhesives
- 95 Grouting material and elastic joint sealants
- 117 Substrate preparation products
- 135 Waterproofing
- 149 concept systems



Profiles

Decorative profiles

Crystal collection	7
Pearls collection	15
Elegance collection	17
Gold collection	25
Metal collection	27
Chrome collection	43
Wood collection	45
pro-telo collection	46

Corner profiles and trims for wall tiles

pro-mate 2	49
pro-mate 3	50
pro-mate 5	51
pro-part Li	52
pro-part	53
pro-mate 45	55
pro-corner	57
XLIGHT profiles	58

Technical profiles

pro-T	61
pro-level	62
pro-shower	63
pro-balcony	64
pro-dilata	65
structural joints	67
pro-step	68
pro-flex	69
pro-sanit	70
pro-plint	71
pro-skirting	72

Graphic index

Decorative profiles



Crystal collection
Page 7



Pearls collection
Page 15



Elegance collection
Page 17



Gold collection
Page 25



Metal collection
Page 27



Chrome collection
Page 43



Wood collection
Page 45



pro-telo collection
Page 46

Corner profiles and trims for wall tiles



pro-mate 2
Page 49



pro-mate 3
Page 50



pro-mate 5
Page 51



pro-part Li
Page 52



pro-part
Page 53



pro-mate 45
Page 55

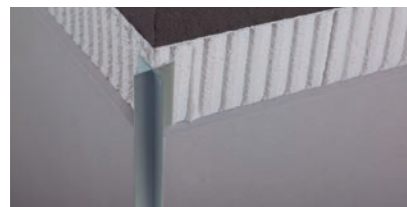

pro-corner
Page 57

Technical profiles

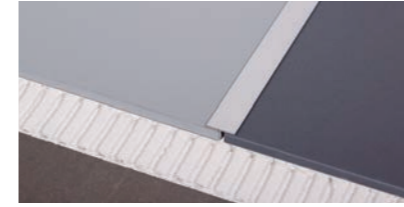

pro-T
Page 61

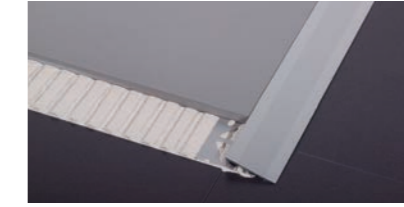

pro-level
Page 62

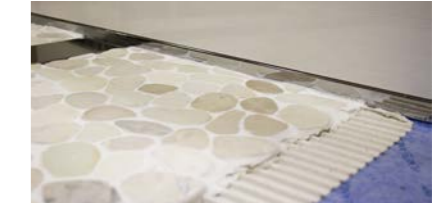

pro-shower
Page 63

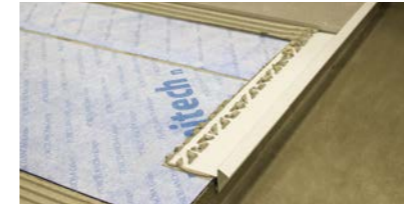

pro-balcony
Page 64



pro-dilata
Page 65

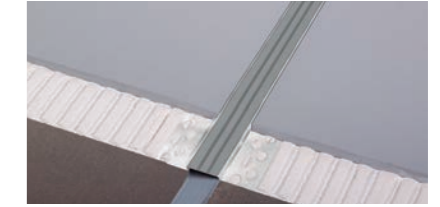

Structural joints
Page 67

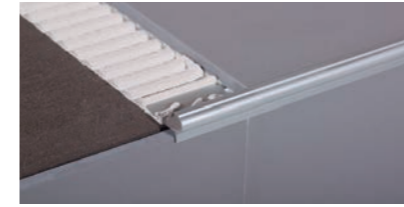

pro-step
Page 68

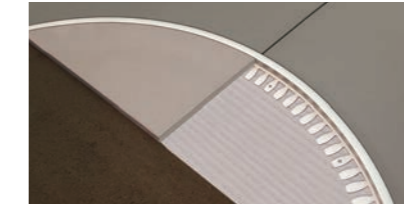

pro-flex
Page 69



pro-sanit
Page 70



pro-plint
Page 71



pro-skirting
Page 72



Decorative profiles

Crystal collection

High-end decorative profile for ceramic wall tiling, made with Swarovski crystals.
Replaces the traditional decorative ceramic listellos by new design metallic lines.



pro-part Li Crystal SW Galaxy

pro-part Li Crystal SW Galaxy

Perfil de latón cromado. Hecho con Swarovski Elements



pro-part Li Crystal SW Galaxy 11 mm
11x11x 2500 mm

B71342657 100171653
383,52 p/u

Crystal collection

High-end decorative profile for ceramic wall tiling, made with Swarovski crystals.
Replaces the traditional decorative ceramic listellos by new design metallic lines.



pro-part Li Crystal rock SW Silver

pro-part Li Crystal rock SW Silver

Perfil de latón cromado. Hecho con Swarovski Elements

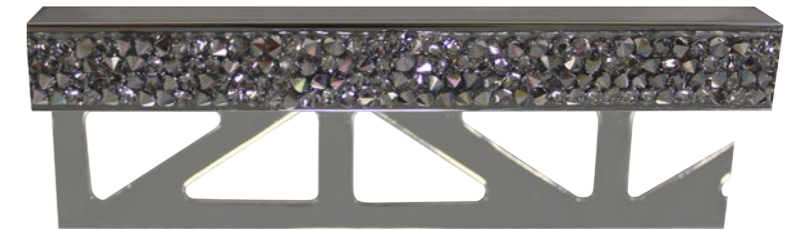

pro-part Li Crystal rock SW Silver 11 mm
11x11x2500 mm

B73141325 100130429
447,78p/u

pro-part Li Crystal rock SW Graphite

Brass profile with dark metallic finish. Made with Swarovski Elements

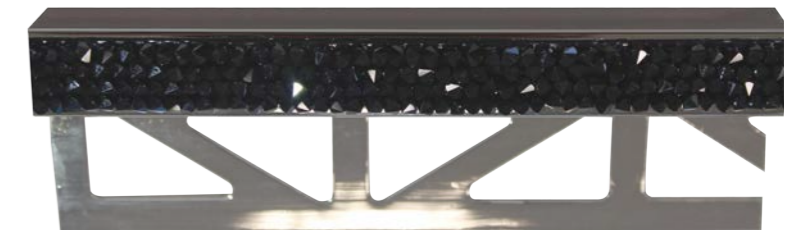

pro-part Li Crystal rock SW Graphite 11 mm
11x11x 2500 mm

B73141326 100130428
501,84 p/u

Crystal collection

High-end decorative profile for ceramic wall tiling, made with Swarovski crystals.
Replaces the traditional decorative ceramic listellos by new design metallic lines.



pro-part Crystal SW Gold

pro-part Crystal SW Gold

24 k gold plated. Made with Swarovski Elements

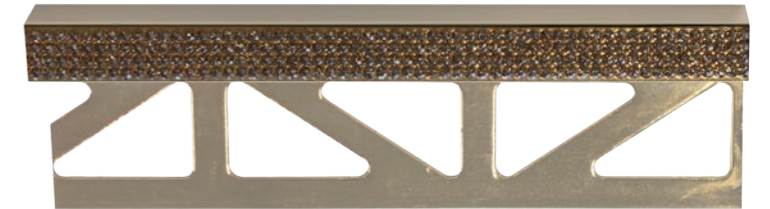

pro-part Crystal SW Gold 11 mm
8 x 11 x 2500 mm

B71342629 100155354
606,80 p/u

pro-part Crystal SW Silver

Chromed brass profile. Made with Swarovski Elements

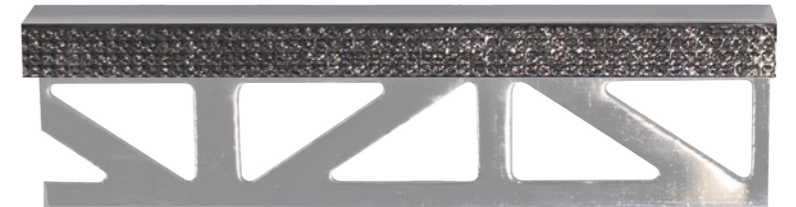

pro-part Crystal SW Silver 11 mm
8 x 11 x 2500 mm

B71342631 100155356
539,33 p/u

pro-part Crystal SW Graphite

Chromed brass profile. Made with Swarovski Elements



pro-part Crystal SW Graphite 11 mm
8x11x2500 mm

B71342630 100155355
610,78 p/u

Crystal collection

High-end decorative profile for ceramic wall tiling, made with Swarovski crystals.
Replaces the traditional decorative ceramic listellos by new design metallic lines.



pro-part Li Crystal sand SW Silver

pro-part Li Crystal sand SW Gold

24 k gold plated. Made with Swarovski Elements

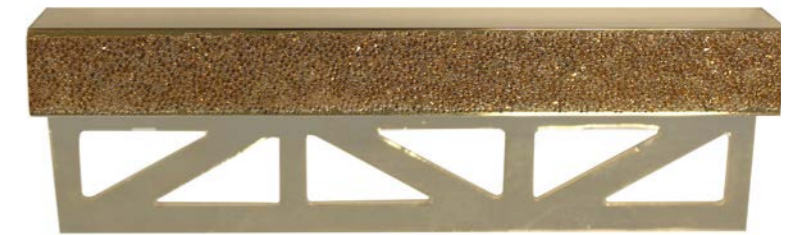

pro-part Li Crystal sand SW Gold 11 mm
11x11x2500 mm

B73141323 100130430
373,32 p/u

pro-part Li Crystal sand SW Silver

Chromed brass profile. Made with Swarovski Elements

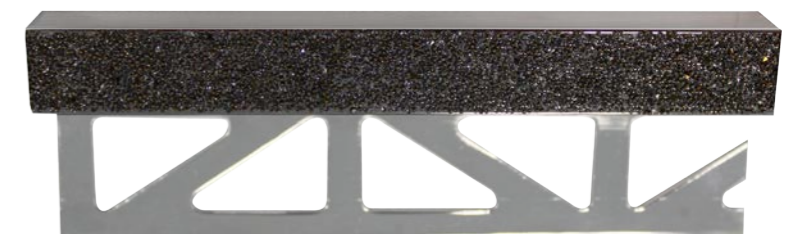

pro-part Li Crystal sand SW Silver 11 mm
11x11x2500 mm

B73141322 100130431
318,24 p/u

Pearls collection

High-end decorative profile for ceramic wall tiling, made with Swarovski pearls.
Replaces the traditional decorative ceramic listellos by new design metallic lines.



pro-part Li Pearls SW Silver

pro-part Li Pearls SW Gold

24 carat gold plated profile. Made with Swarovski elements



pro-part Li Pearls SW Gold 11 mm
11x11x2500 mm

B71342632 100155357
576,40 p/u

pro-part Li Pearls SW Silver

Chromed brass profile. Made with Swarovski Elements



pro-part Li Pearls SW Silver 11 mm
11x11x2500 mm

B71342628 100155325
549,68 p/u

Elegance collection

High-end decorative profile for ceramic wall tiling, made with Swarovski crystals.
Replaces the traditional decorative ceramic listellos by new design metallic lines.



pro-part Li chromed brass SW 1500

pro-part Li Gold SW 1500

24 k gold plated. Made with Swarovski Elements



pro-part Li Gold SW 1500 11 mm
11 x 11 x 2500 mm

B73141324 100130432
545,70 p/u

pro-part Li Chrome SW 1500

Chromed brass profile. Made with Swarovski Elements



pro-part Li chromed brass SW 1500 11 mm
11 x 11 x 2500 mm

B71342597 100120372
499,80 p/u

Elegance collection

High-end decorative profile for ceramic wall tiling, made with Swarovski crystals.
Replaces the traditional decorative ceramic listellos by new design metallic lines.



pro-mate 5 Chrome SW 500

pro-mate 5 Gold SW 500

24 k gold plated. Made with Swarovski Elements



pro-mate 5 Gold SW 500 11 mm
5x11x2500 mm

B71342585 100104649
373,22 p/u

pro-mate 5 Chrome SW 500

Chromed brass profile. Made with Swarovski Elements



pro-mate 5 chromed brass SW 500 11 mm
5x11x2500 mm

B71342584 100104650
346,65 p/u

Elegance collection

High-end decorative profile for ceramic wall tiling, made with Swarovski crystals.
Replaces the traditional decorative ceramic listellos by new design metallic lines.

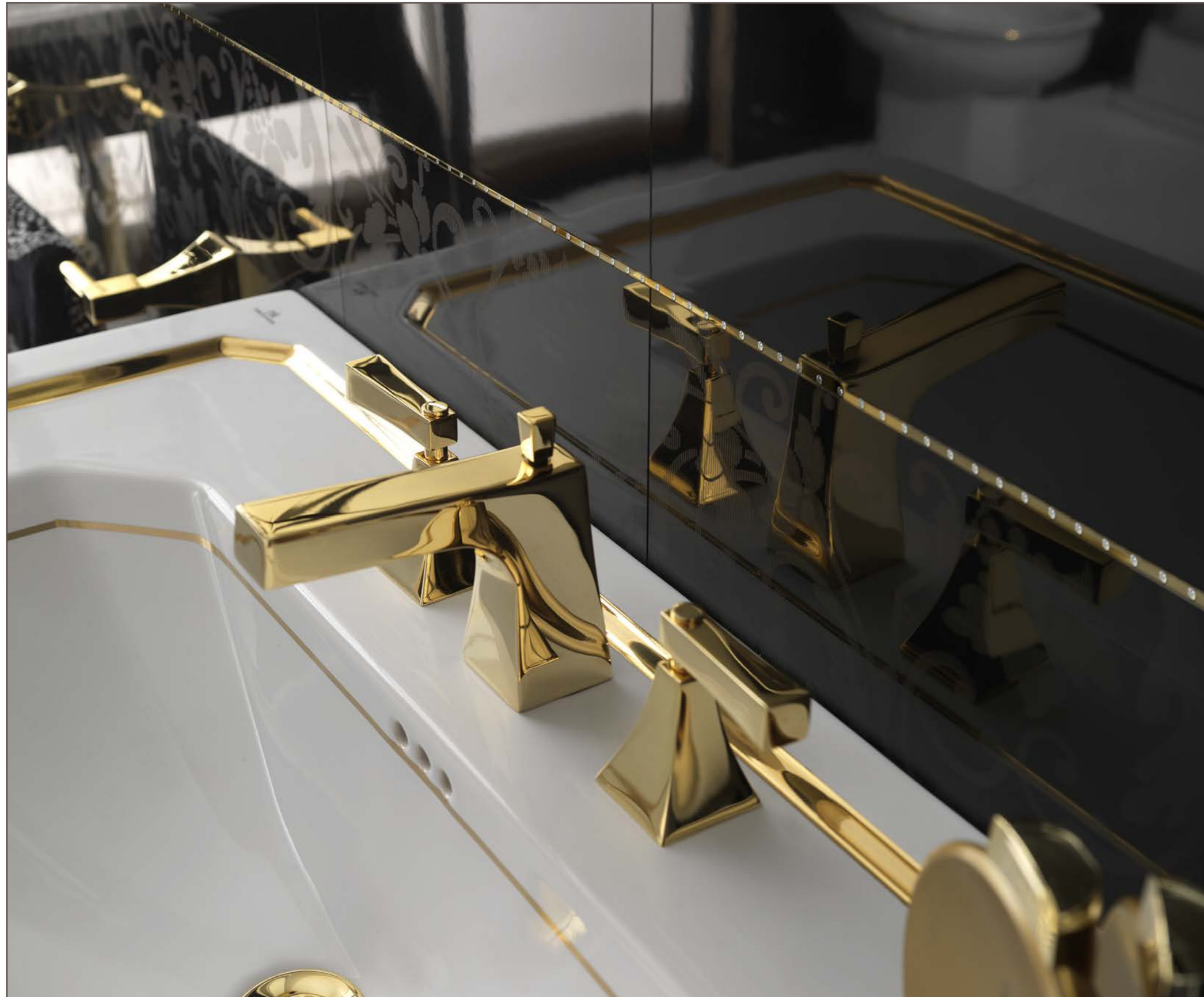

pro-mate 5 Gold SW 168

pro-mate 5 Gold SW 168

24 k gold plated. Made with Swarovski Elements



pro-mate 5 Gold SW 168 11 mm
5x11x2500 mm

B71342587 100109076
292,14 p/u

pro-mate 5 Chrome SW 168

Chromed brass profile. Made with Swarovski Elements



pro-mate 5 chromed brass SW 168 11 mm
5x11x2500 mm

B71342586 100109077
201,96 p/u

Elegance collection

High-end decorative profile for ceramic wall tiling, made with Swarovski crystals.
Replaces the traditional decorative ceramic listellos by new design metallic lines.



pro-mate 5 chrome SW glass

pro-mate 5 Gold SW Glass

24 k gold plated. Made with Swarovski Elements

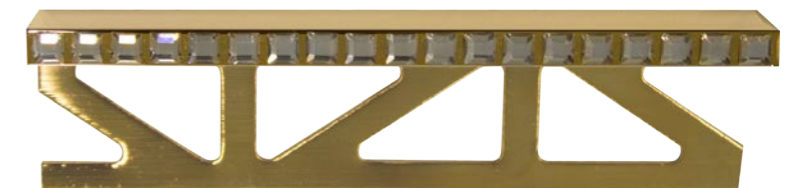

pro-mate 5 Gold SW Glass 11 mm
5x11x2500 mm

B71342639 100158911
351,90 p/u

pro-mate 5 chrome SW glass

Chromed brass profile. Made with Swarovski Elements

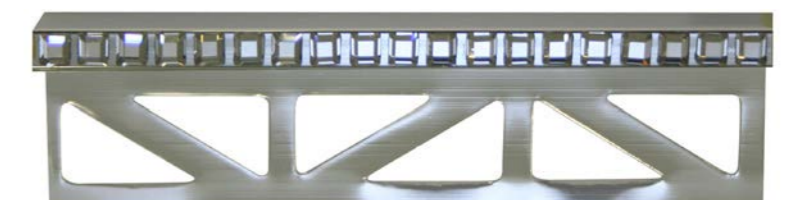

pro-mate 5 chromed brass SW glass 11 mm
5x11x2500 mm

B71342603 100120358
339.85 p/u

Gold collection

High-end decorative profile for wall tiles, 24K gold plated.
It substitutes the traditional ceramic frieze by a metallic line with an exclusive design.



pro-part Gold

pro-part Li Gold

24 carat gold plated profile. 11 mm decorative trim.



pro-part Li gold 24 K 12,5 mm 12,5x11,5x2500 mm	B71342578	100100762 104,55 p/u
pro-part Li gold 24 K 11 mm 11x10x2500 mm	B71342574	100100726 100,62 p/u

pro-part Gold

24 carat gold plated profile. 8 mm decorative trim.



pro-part gold 24 K 12,5 mm 8x12,5x2500 mm	B71342575	100100725 96,34 p/u
pro-part gold 24 K 11 mm 8x11x2500 mm	B71342577	100100724 93,89 p/u

pro-mate 5 Gold

24 carat gold plated profile. 5 mm decorative trim.



pro-mate 5 gold 24 K 12,5 mm 5x12,5x2500 mm	B71342573	100100722 93,18 p/u
pro-mate 5 gold 24 K 11 mm 5x11x2500 mm	B71342572	100100721 92,00 p/u

Metal collection

Metallic finish decorative profiles for ceramic wall tiles. It substitutes the traditional ceramic frieze.



pro-part Rose

pro-part rose

Brass profile with metallic covering, 8 mm decorative trim.

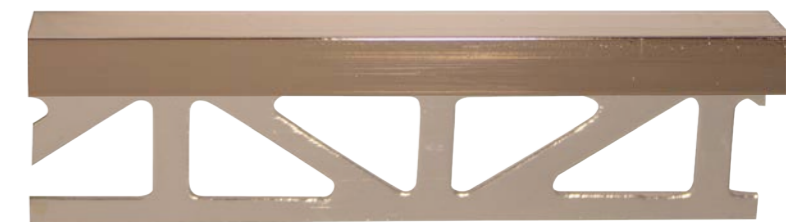

pro-part latón rose 11 mm
8x11x2500 mm

B71342651 100168058
89,56 p/u

Metal collection

Metallic finish decorative profiles for ceramic wall tiles. It substitutes the traditional ceramic frieze.



pro-part Antique

pro-part antique

Brass profile with metallic covering. 8 mm decorative trim.



pro-part antique 11 mm
8x11x2500 mm

B71342650 100168057
86,19 p/u

Metal collection

Metallic finish decorative profiles for ceramic wall tiles. It substitutes the traditional ceramic frieze.



pro-part Ocean

pro-part ocean

Brass profile with metallic covering. 8 mm decorative trim.



pro-part brass ocean 7 mm 8x7x2500 mm	B71342680	100177070 78,10 p/u
pro-part brass ocean 11 mm 8x11x2500 mm	B71342595	100120370 79,25 p/u
pro-part brass ocean 12,5 mm 8x12,5x2500 mm	B71342675	100177072 79,54 p/u

pro-part ocean line

Brass profile with metallic covering. 8 mm decorative trim.



pro-part brass ocean line 7 mm 8x7x2500 mm	B71342677	100177064 79,80 p/u
pro-part brass ocean line 11 mm 8x11x2500 mm	B71342635	100158268 81,09 p/u
pro-part brass ocean line 12,5 mm 8x12,5x2500 mm	B71342666	100177034 81,80 p/u

Metal collection

Metallic finish decorative profiles for ceramic wall tiles. It substitutes the traditional ceramic frieze.



pro-part Moon line

pro-part moon

Brass profile with metallic covering. 8 mm decorative trim.



pro-part brass moon 7 mm 8x7x2500 mm	B71342681	100177056 78,10 p/u
pro-part brass moon 11 mm 8x11x2500 mm	B71342591	100120369 81,55 p/u
pro-part brass moon 12,5 mm 8x12,5x2500 mm	B71342673	100177071 81,80 p/u

pro-part moon line

Brass profile with metallic covering. 8 mm decorative trim.



pro-part brass moon line 7 mm 8x7x2500 mm	B71342683	100177063 79,80 p/u
pro-part brass moon line 11 mm 8x11x2500 mm	B71342634	100158267 81,09 p/u
pro-part brass moon line 12,5 mm 8x12,5x2500 mm	B71342674	100177080 81,80 p/u

Metal collection

Metallic finish decorative profiles for ceramic wall tiles. It substitutes the traditional ceramic frieze.



pro-part Line

pro-part line

Brass profile with metallic covering. 8 mm decorative trim.



pro-part brass line 7 mm 8x7x2500 mm	B71342684	100177061 74,50 p/u
pro-part brass line 11 mm 8x11x2500 mm	B71342593	100120367 77,11 p/u
pro-part brass line 12,5 mm 8x12,5x2500 mm	B71342678	100177058 81,80 p/u

pro-part line matt

Brass profile with metallic covering. 8 mm decorative trim.



pro-part brass line matt 7 mm 8x7x2500 mm	B71342682	100177062 74,50 p/u
pro-part brass line matt 11 mm 8x11x2500 mm	B71342633	100157798 77,11 p/u
pro-part brass line matt 12,5 mm 8x12,5x2500 mm	B71342676	100177059 77,90 p/u

Metal collection

Metallic finish decorative profiles for ceramic wall tiles. It substitutes the traditional ceramic frieze.



pro-part Oxyde

pro-mate 5 oxyde

Brass profile with metallic covering. 5 mm decorative trim.



pro-mate 5 brass oxyde 11 mm
5x11x2500 mm

B71342599 100120364
90,07 p/u

pro-part oxyde

Brass profile with metallic covering. 8 mm decorative trim.



pro-part antique 11 mm
8x11x2500 mm

B71342601 100120371
95,98 p/u

Metal collection

Metallic finish decorative profiles for ceramic wall tiles. It substitutes the traditional ceramic frieze.



pro-part Graphite

pro-part graphite

Brass profile with metallic covering, 5 mm decorative trim.



pro-part brass graphite 7 mm 8x7x2500 mm	B71342671	100177049 75,40 p/u
pro-part brass graphite 11 mm 8x11x2500 mm	B71342590	100120366 80,68 p/u
pro-part brass graphite 12,5 mm 8x12,5x2500 mm	B71342667	100177035 81,50 p/u

pro-mate 5 graphite

Brass profile with metallic covering, 8 mm decorative trim.



pro-mate 5 graphite 7 mm 5x7x2500 mm	B71342670	100177054 71,50 p/u
pro-mate 5 graphite 11 mm 5x11x2500 mm	B71342598	100120359 75,38 p/u
pro-mate 5 graphite 12,5 mm 5x12,5x2500 mm	B71342665	100177048 75,40 p/u

Metal collection

Metallic finish decorative profiles for ceramic wall tiles. It substitutes the traditional ceramic frieze.



pro-part Graphite matt

pro-part graphite matt

Brass profile with metallic covering. 8 mm decorative trim.



pro-part brass graphite matt 7 mm 8x7x2500 mm	B71342672	100177037 84,20 p/u
pro-part brass graphite matt 11 mm 8x11x2500 mm	B71342636	100158266 83,33 p/u
pro-part brass graphite matt 12,5 mm 8x12,5x2500 mm	B71342668	100177053 83,60 p/u

pro-part graphite matt line

Brass profile with metallic covering. 8 mm decorative trim.



pro-part brass graphite matt line 7 mm 8x7x2500 mm	B71342679	100177055 84,20 p/u
pro-part brass graphite matt line 11 mm 8x11x2500 mm	B71342637	100158265 83,33 p/u
pro-part brass graphite matt line 12,5 mm 8x12,5x2500 mm	B71342669	100177036 83,90 p/u

Chrome collection

Chromed brass decorative profile for wall tiles. It substitutes the traditional decorative ceramic frieze. Typical LIFESTYLE by PROCELANOSA profile.

Suitable for trimming corners and transitions between ceramic tiles.

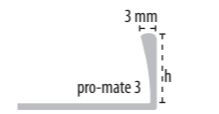
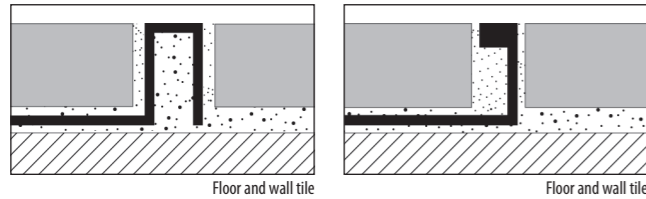

pro-mate 3

Chromed brass

KEA	SAP		h (mm)	P/EU
B71342608	100126772	XLIGHT	6	49,88 p/u
B71133001	100004951		8	51,38 p/u
B71133002	100004952		9	50,49 p/u
B71133003	100004953		10	51,10 p/u
B71133004	100004954		12,5	52,33 p/u

pro-mate 5

Chromed brass

KEA	SAP		h (mm)	P/EU
B71342611	100126779	XLIGHT	7	58,14 p/u
B71132003	100004945		9	58,45 p/u
B71132004	100004946		11	60,59 p/u
B71134004	100004955		12,5	62,73 p/u

pro-part

Chromed brass

KEA	SAP		h (mm)	P/EU
B73134001	100005368	XLIGHT	7	62,12 p/u
B73134002	100005369		9	64,57 p/u
B71342552	100088905		10	65,59 p/u
B73134003	100005370		11	67,01 p/u
B73141319	100097895	Porcelanosa	11	70,07 p/u
B73134004	100005371	Shade 1	12,5	69,16 p/u
B73141312	100033129	Shade 2	12,5	69,16 p/u
B73134005	100005372		15	72,83 p/u

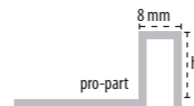

Chromed brass corner

KEA	SAP		h (mm)	P/EU
B73134301	100005373	XLIGHT	7	23,26 p/u
B73134302	100005374		9	23,26 p/u
B71342554	100091065		10	23,31 p/u
B73134303	100005375		11	23,26 p/u
B73134304	100005376		12,5	23,26 p/u
B71342541	100067718		15	25,30 p/u



pro-part Li

Chromed brass

KEA	SAP		h (mm)	a (mm)	P/EU
B71342618	100126780	XLIGHT	4,5	5,5	66,10 p/u
B71342542	100070170		11	12	76,50 p/u
B71342543	100070171		12,5	13,5	80,58 p/u

Chromed brass corner

KEA	SAP		h (mm)	P/EU
B72141343	100098464		11	25,09 p/u
B71342550	100085153		12,5	27,54 p/u

pro-telo mosaic

Chromed brass

KEA	SAP		h (mm)	P/EU
B72141345	100099966	Mosaic 25	4	70,38 p/u



Wood collection

Wood profiles for wall and floor tile coverings. Page Excellent solution for the design of ceramic settings with either contemporary or traditional style.

Available as a decorative line for ceramic wall tiles and as special pieces for steps.

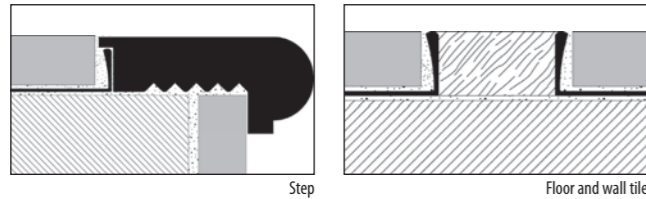

pro-telo W

pro-telo W 15 chromed brass

KEA	SAP		h (mm)	P/EU
B72141306	100032362	Caoba 15	12.5	140,72 p/u
B72141309	100032360	Wenge 15	12.5	150,60 p/u
B72141314	100032364	Nogal 15	12.5	143,19 p/u

pro-telo W 25 chromed brass

KEA	SAP		h (mm)	P/EU
B72141305	100032363	Caoba 25	12.5	143,19 p/u
B72141312	100032361	Wenge 25	12.5	153,07 p/u
B72141310	100032365	Nogal 25	12.5	148,12 p/u

pro-telo carbono

pro-telo 11x30 carbono

KEA	SAP	h (mm)	P/EU
B72141321	100089390	11	91,80 p/u

pro-step W Toscana

KEA	SAP		h (mm)	P/EU
B76211008	100158280	wenge	12,5	112,1 p/u
B76211007	100158269	caoba	12,5	112,1 p/u

pro-step W Milano

KEA	SAP		h (mm)	P/EU
B76211006	100005503	Milano	12.5	92,92 p/u

pro-step W Avignon

KEA	SAP		h (mm)	P/EU
B76211001	100005498	Avignon	10	90,87 p/u

Do not use **pro-telo W** profiles in coverings which come into direct contact with water.

pro-step W profiles are supplied untreated so that the final user can choose the finishing of the step.

Profile length: 2500 mm

Minimum packaging: 10 profiles

pro-telo collection

Metal decorative profile for ceramic wall tiles. Flangeless metallic line for tiles of any thickness.

Available in a wide variety of materials, finishes and dimensions, they represent an excellent solution for the design of contemporary style ceramic settings.

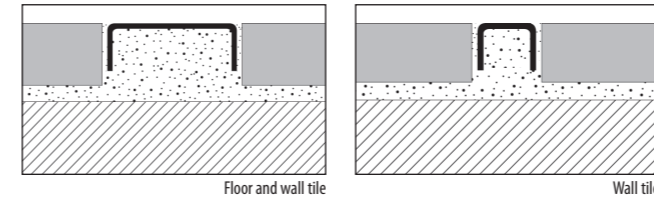

pro-telo stainless 8x40

Stainless Steel 8x40

KEA	SAP		h (mm)	P/EU
B72141110	100005299	Gloss	8	69,56 p/u
B72141210	100005306	Brushed	8	77,98 p/u

pro-telo stainless 8x25

Stainless Steel 8x25

KEA	SAP		h (mm)	P/EU
B72141101	100005293	Gloss	8	38,82 p/u
B72141201	100005300	Brushed	8	51,11 p/u
B72141320	100089391	Squared chrome	8	81,60 p/u

pro-telo stainless 8x10

KEA	SAP		h (mm)	P/EU
B72141005	100005291	Matt URBATEK	8	33,10 p/u
B72141006	100005292	Gloss URBATEK	8	31,68 p/u

pro-telo aluminium

Aluminium 8x10 gloss

KEA	SAP		h (mm)	P/EU
B72124001	100005288	Gold	10	26,51 p/u
B72124002	100005289	Silver	10	26,51 p/u

Aluminium 8x10 anodized

KEA	SAP		h (mm)	P/EU
B72122001	100005285	Gold	10	18,22 p/u
B72122002	100005286	Silver	10	16,87 p/u

pro-telo recto

Aluminium 8x10

KEA	SAP		h (mm)	P/EU
B72141318	100084015	High gloss	8	19,38 p/u
B72141348	100100729	Silver anodized	8	15,81 p/u
B72141346	100100730	Titanium	8	17,34 p/u
B72141350	100100727	Cosmos	8	19,69 p/u

Profile length: 2500 mm

pro-telo titanium profile length: 2400 mm

Minimum packaging: 10 profiles



Corner profiles and trims for wall tiles

pro-mate 2

Right angle, stainless steel profile for corners and wall and floor tile coverings.

Right angle, stainless steel profiles for trimming the non-glazed edge of the tile. Suitable for separating tiles in walls as well as in floors.

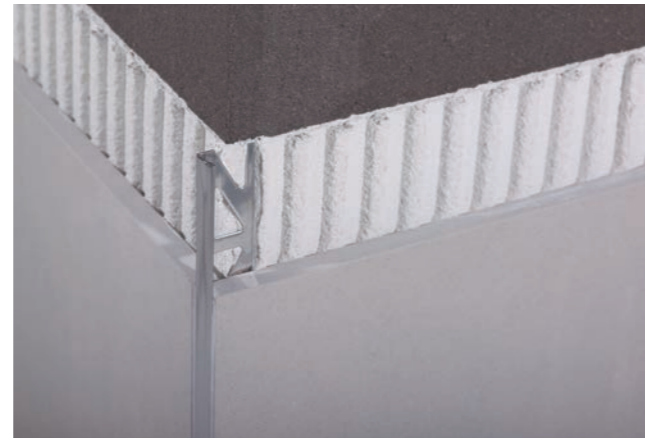
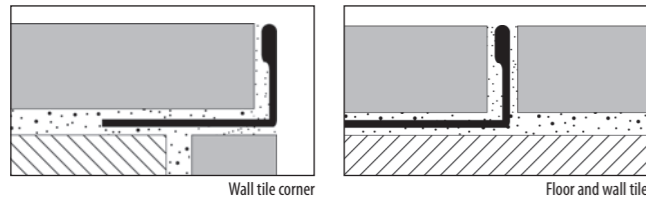

pro-mate 2

V2A Stainless steel

KEA	SAP		h (mm)	P/EU
B71342617	100126769	XLIGHT	6	24,12 p/u
B71141001	100004956		8	23,29 p/u
B71141002	100004957		10	24,41 p/u
B71141003	100004958		12.5	25,25 p/u
B71141004	100004959		15	36,76 p/u
B71141005	100004960		20	38,83 p/u

Gloss stainless steel

KEA	SAP		h (mm)	P/EU
B71142001	100004966		8	35,07 p/u
B71142002	100004967		10	36,47 p/u
B71142003	100004968		12.5	37,59 p/u
B71142004	100004969		15	45,39 p/u

V4A Stainless steel

KEA	SAP		h (mm)	P/EU
B71141008	100004963		8	25,81 p/u
B71141009	100004964		10	26,93 p/u
B71141010	100004965		12.5	30,19 p/u

pro-mate 3

Right angle profile for corners and wall and floor tile coverings. Decorative use as a metallic line.

Right angle, 3 mm thick profiles for trimming the non-glazed edge of the tile. Available in a wide variety of materials, they are also suitable for separating wall tiles.

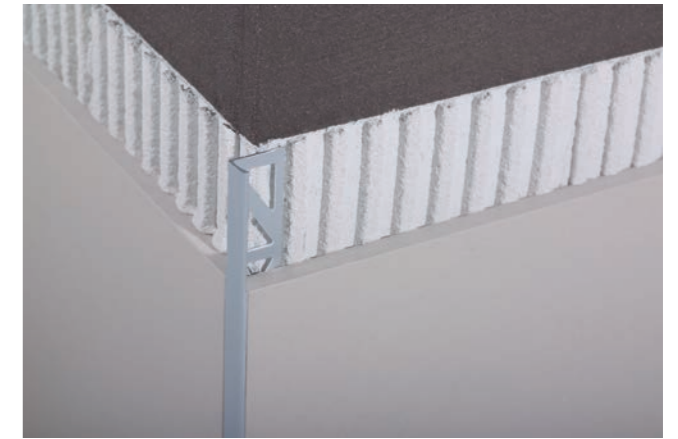
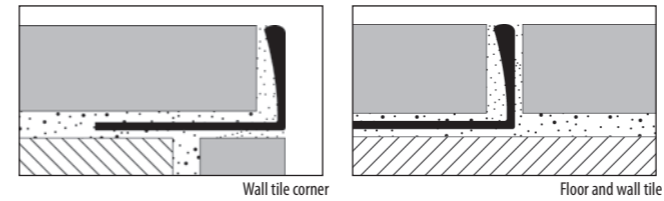

pro-mate 3

Chromed brass

KEA	SAP		h (mm)	P/EU
B71342608	100126772	XLIGHT	6	49,88 p/u
B71133001	100004951		8	51,38 p/u
B71133002	100004952		9	50,49 p/u
B71133003	100004953		10	51,10 p/u
B71133004	100004954		12.5	52,33 p/u

Anodized aluminium silver

KEA	SAP		h (mm)	P/EU
B71342616	100126770	XLIGHT	6	18,85 p/u
B71122001	100004899		8	10,44 p/u
B71122002	100004900		9	10,71 p/u
B71122003	100004901		10	10,98 p/u
B71122004	100004902		12.5	11,78 p/u
B71122005	100004903		15	13,39 p/u

Lacquered aluminium

KEA	SAP		h (mm)	P/EU
B71342609	100126771	White XLIGHT	6	14,18 p/u
B71123001	100004909	White	8	14,46 p/u
B71123003	100004911	White	10	15,26 p/u
B71123004	100004912	White	12.5	16,61 p/u
B71123005	100004913	Beige	8	14,46 p/u
B71123007	100004915	Beige	10	15,26 p/u
B71123008	100004916	Beige	12.5	16,61 p/u
B71123009	100004917	Negro	8	14,46 p/u
B71123011	100004919	Negro	10	15,26 p/u
B71123012	100004920	Negro	12.5	16,61 p/u

High gloss aluminium

KEA	SAP		h (mm)	P/EU
B71124003	100004925		10	23,33 p/u
B71124004	100004926		12.5	24,03 p/u

PVC

KEA	SAP		h (mm)	P/EU
B71111009	100004865	White	10	4,86 p/u
B71111017	100004873	White	12.5	5,23 p/u
B71111010	100004866	Jazmín	10	4,86 p/u
B71111018	100004874	Jazmín	12.5	5,23 p/u
B71111011	100004867	Beige	10	4,86 p/u
B71111019	100004875	Beige	12.5	5,23 p/u
B71111012	100004868	Negro	10	4,86 p/u
B71111020	100004876	Negro	12.5	5,23 p/u
B71111013	100004869	Grey	10	4,86 p/u
B71111021	100004877	Grey	12.5	5,23 p/u
B71111014	100004870	Marfil	10	4,86 p/u
B71111022	100004878	Marfil	12.5	5,23 p/u

pro-mate 5

Right angle profile for corners and wall and floor tile coverings. Decorative use as a metallic line.
Right angle and 5 mm edge profiles for trimming the non-glazed edge of the tile. Suitable for transitions between floor coverings at the same level.

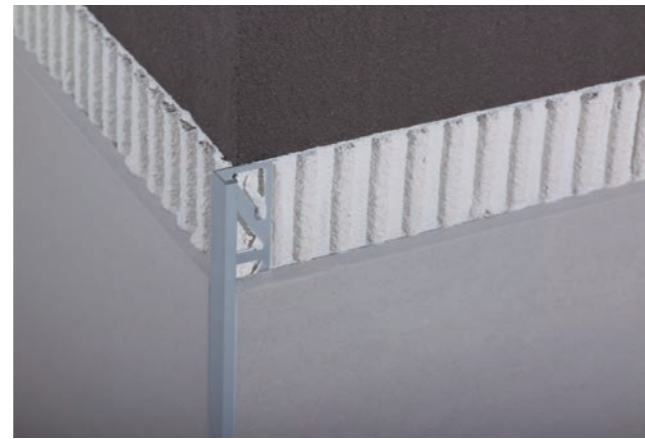
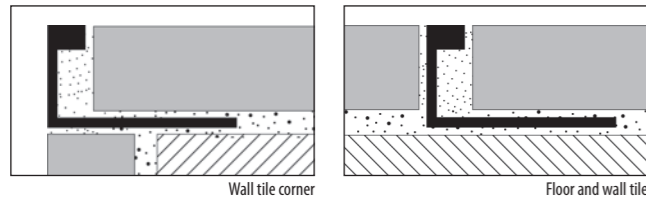

pro-mate 5

Chromed brass

KEA	SAP		h (mm)	P/EU
B71342611	100126779	XLIGHT	7	58,14 p/u
B71132003	100004945		9	58,45 p/u
B71132004	100004946		11	60,59 p/u
B71134004	100004955		12,5	62,73 p/u

Gloss polished brass

KEA	SAP		h (mm)	P/EU
B71132002	100004944		11	44,98 p/u

Anodized aluminium silver

KEA	SAP		h (mm)	P/EU
B71125003	100004927		11	16,63 p/u

pro-part Li

Decorative profile for ceramic wall tiles. Suitable for trimming corners and transitions between ceramic tiles.

Right angle, corner shaped profiles, with both sides of the same length. Specially recommended for rectified tiles corners and for tiles with relief decoration.

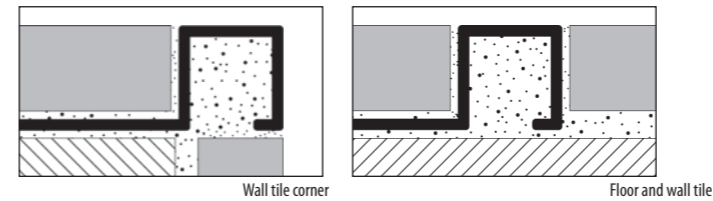

pro-part Li

Chromed brass

KEA	SAP		h (mm)	a (mm)	P/EU
B71342618	100126780	XLIGHT	4,5	5,5	66,10 p/u
B71342542	100070170		11	12	76,50 p/u
B71342543	100070171		12,5	13,5	80,58 p/u
B71342545	100073492		15	16	82,62 p/u

Anodized aluminium silver

KEA	SAP		h (mm)	a (mm)	P/EU
B71342619	100128227	XLIGHT	4,5	5,5	14,74 p/u
B71342539	100062074		11	12	19,58 p/u
B71342537	100062086		12,5	13,5	21,42 p/u

High gloss aluminum

KEA	SAP		a (mm)	h (mm)	P/EU
B71342535	100062072		11	10	40,29 p/u
B71342538	100062073		12,5	11,5	43,35 p/u



Chromed brass corner

KEA	SAP		h (mm)	P/EU
B72141343	100098464		11	25,09 p/u
B71342550	100085153		12,5	27,54 p/u

Anodized aluminium silver corner

KEA	SAP		h (mm)	P/EU
B71342557	100093706		11	23,05 p/u
B71342556	100093705		12,5	23,05 p/u

High gloss aluminum

KEA	SAP		h (mm)	P/EU
B71342581	100102763		11	10,35 p/u
B71342580	100102762		12,5	12,60 p/u

pro-part

Decorative profile for ceramic wall tiles. Suitable for trimming corners and transitions between ceramic tiles.

Right angle, corner shaped profiles, with an 8 mm edge and a variable width edge. Excellent solution for a wide variety of ceramic installations.

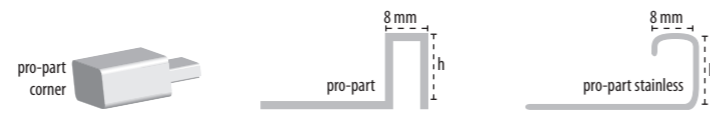
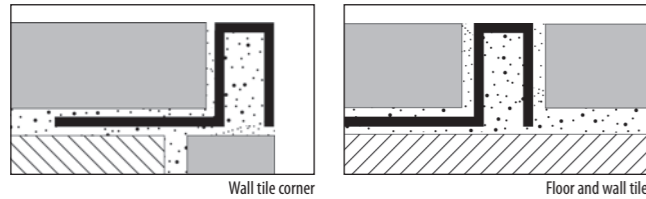

pro-part

Chromed brass

KEA	SAP		h (mm)	P/EU
B73134001	100005368	XLIGHT	7	62,12 p/u
B73134002	100005369		9	64,57 p/u
B71342552	100088905		10	65,59 p/u
B73134003	100005370		11	67,01 p/u
B73134004	100005371	Shade 1	12.5	69,16 p/u
B73141312	100033129	Shade 2	12.5	69,16 p/u
B73134005	100005372		15	72,83 p/u

Stainless steel

KEA	SAP		h (mm)	P/EU
B73141009	100005377		9	31,98 p/u
B73141010	100005378		11	34,22 p/u
B73141011	100005379		12.5	37,03 p/u

Anodized aluminium silver

KEA	SAP		h (mm)	P/EU
B73122001	100005322	XLIGHT	7	14,99 p/u
B73122002	100005323		9	15,80 p/u
B73122003	100005324		11	16,61 p/u
B73122004	100005325		12.5	18,21 p/u
B73122005	100005326		15	19,82 p/u
B73122006	100005327		20	21,42 p/u
B73122007	100005328		25	22,23 p/u

Anodized aluminium gold

KEA	SAP		h (mm)	P/EU
B73122009	100005330		9	16,61 p/u
B73122010	100005331		11	17,40 p/u
B73122011	100005332		12.5	18,75 p/u
B73122014	100005335		25	23,30 p/u

High gloss aluminium

KEA	SAP		h (mm)	P/EU
B73141317	100089004		11	60,03 p/u
B73124004	100005353		12.5	60,03 p/u

Black matt aluminium

KEA	SAP		h (mm)	P/EU
B71342659	100171975		11	31,11 p/u

Chromed brass corner

KEA	SAP		h (mm)	P/EU
B73134301	100005373	XLIGHT	7	23,26 p/u
B73134302	100005374		9	23,26 p/u
B71342554	100091065		10	23,31 p/u
B73134303	100005375		11	23,26 p/u
B73134304	100005376		12.5	23,26 p/u
B71342541	100067718		15	25,30 p/u

Stainless steel corner

KEA	SAP		h (mm)	P/EU
B73141309	100005380		9	23,56 p/u
B73141310	100005381		11	23,56 p/u
B73141311	100005382		12.5	25,45 p/u

Anodized aluminium silver corner

KEA	SAP		h (mm)	P/EU
B73122301	100005336	XLIGHT	7	18,21 p/u
B73122302	100005337		9	18,21 p/u
B73122303	100005338		11	18,21 p/u
B73122304	100005339		12.5	18,21 p/u



pro-part

Lacquered aluminium

KEA	SAP		h (mm)	P/EU
B71342551	100088551	Negro	11	29,77 p/u
B71342547	100080530	Negro	12.5	30,84 p/u
B71342576	100100723	White	11	29,77 p/u
B71342549	100083438	White	12.5	30,84 p/u

Gloss polished brass

KEA	SAP		h (mm)	P/EU
B73132003	100005363		11	56,30 p/u
B73132004	100005364		12.5	58,14 p/u

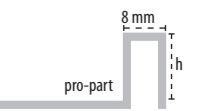

pro-mate 45

Rounded profile for protecting wall tiles corners.

These profiles are the classic solution for protecting corners in wall tile coverings. Available in a wide variety of materials, its main feature is being shock-resistant.

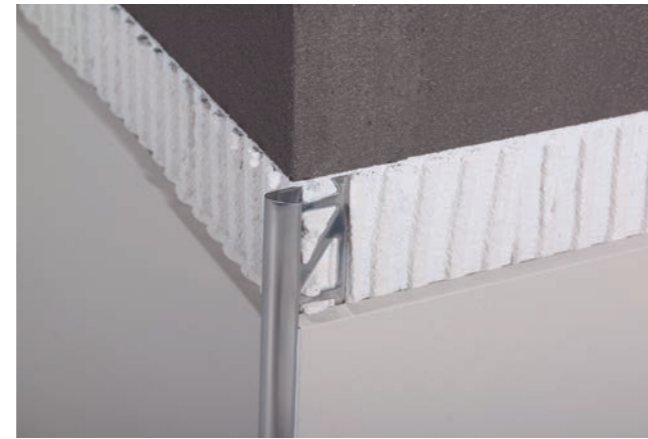
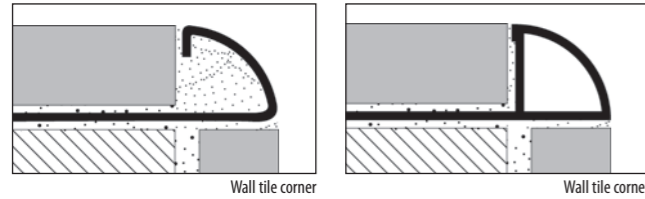

pro-mate 45 TOP

Chromed brass

KEA	SAP		h (mm)	P/EU
B71342614	100126778	TOP XLIGHT	6	60,18 p/u
B71342565	100099965	TOP	10	61,46 p/u
B71342620	100128801	TOP	12,5	71,35 p/u

Anodized aluminium silver

KEA	SAP		h (mm)	P/EU
B71342612	100126777	TOP XLIGHT	6	19,58 p/u

pro-mate 45 brass

Chromed brass

KEA	SAP		h (mm)	P/EU
B71342615	100126776	XLIGHT	6	63,24 p/u
B71342566	100099963		10	69,67 p/u
B71342567	100099964		12,5	74,46 p/u

pro-mate 45 stainless steel

Stainless steel V2A

KEA	SAP		h (mm)	P/EU
B71342613	100126775	XLIGHT	6	27,97 p/u
B71341001	100005156		8	31,21 p/u
B71341002	100005157		10	34,70 p/u
B71341003	100005158		12,5	36,06 p/u

Gloss stainless steel

KEA	SAP		h (mm)	P/EU
B71342001	100005160		8	37,03 p/u
B71342002	100005161		10	38,71 p/u
B71342003	100005162		12,5	40,95 p/u

pro-mate 45 aluminium

Anodized aluminium silver

KEA	SAP		h (mm)	P/EU
B71342607	100126774	XLIGHT	6	12,34 p/u
B71322001	100005092		8	12,32 p/u
B71322003	100005094		10	13,39 p/u
B71322005	100005096		12,5	14,73 p/u

Chromed brass corner

KEA	SAP		h (mm)	P/EU
B71342606	100125537		10	30,55 p/u

Gloss polished brass

KEA	SAP		h (mm)	P/EU
B71332003	100005155		12,5	53,55 p/u

Stainless steel corner

KEA	SAP		h (mm)	P/EU
B71341501	100005159		8	19,19 p/u

Gloss stainless steel corner

KEA	SAP		h (mm)	P/EU
B71342504	100005163		8	25,13 p/u
B71342505	100005164		10	25,13 p/u
B71342506	100005165		12,5	25,13 p/u

Anodized aluminium gold

KEA	SAP		h (mm)	P/EU
B71322002	100005093		8	12,32 p/u
B71322004	100005095		10	13,39 p/u
B71322006	100005097		12,5	14,73 p/u

pro-mate 45 aluminio

Lacquered aluminium

KEA	SAP		h (mm)	P/EU
B71342610	100126773	White XLIGHT	6	15,31 p/u
B71323005	100005113	White	10	15,30 p/u
B71323009	100005117	White	12,5	16,58 p/u
B71323006	100005114	Beige	10	15,30 p/u
B71323010	100005118	Beige	12,5	16,58 p/u
B71323007	100005115	Pergamon	10	15,76 p/u
B71323011	100005119	Pergamon	12,5	16,58 p/u

High gloss aluminium

KEA	SAP		h (mm)	P/EU
B71342562	100096222		10	24,37 p/u
B71342570	100100665		12,5	25,49 p/u

Anodized aluminium gloss gold

KEA	SAP		h (mm)	P/EU
B71342571	100100666		12,5	25,49 p/u

pro-mate 45 PVC gloss

PVC

KEA	SAP		h (mm)	P/EU
B71211007	100004979	White	10	7,48 p/u
B71211025	100004993	White	12,5	5,79 p/u
B71211026	100004994	Jazmín	12,5	5,79 p/u
B71211008	100004980	Marfil	10	7,48 p/u
B71211031	100004998	Marfil	12,5	5,79 p/u
B71211009	100004981	Beige	10	7,48 p/u
B71211027	100004995	Beige	12,5	5,79 p/u
B71211010	100004982	Grey	10	7,48 p/u
B71211028	100004996	Grey	12,5	5,79 p/u

pro-mate 45 PVC matt

PVC Closed

KEA	SAP		h (mm)	P/EU
B71311010	100005084	White	10	5,43 p/u
B71311011	100005085	Jazmín	10	5,43 p/u
B71311014	100005088	Marfil	10	5,43 p/u

pro-mate 45 PVC II

PVC II

KEA	SAP		h (mm)	P/EU
B71342512	100046964	White	10	1,39 p/u
B71342510	100047009	White	12,5	1,53 p/u
B71342514	100047012	Grey	10	1,39 p/u
B71342513	100047010	Grey	12,5	1,53 p/u
B71342515	100047013	Marfil	10	1,39 p/u
B71342511	100047008	Marfil	12,5	1,53 p/u

Lacquered aluminium corner

KEA	SAP		h (mm)	P/EU
B71323505	100005142	White	10	11,93 p/u
B71323516	100005147	Beige	12,5	11,93 p/u
B71323507	100005144	Pergamon	10	11,93 p/u
B71323517	100005148	Pergamon	12,5	12,89 p/u

High gloss aluminium corner

KEA	SAP		h (mm)	P/EU
B71342563	100096461		10	24,1 p/u

PVC corner

KEA	SAP		h (mm)	P/EU
B71211325	100005027	White blister	12,5	3,07 p/bag
B71211317	100005023	Jazmín blister	10	3,29 p/bag
B71211326	100005028	Jazmín blister	12,5	3,07 p/bag
B71211308	100005014	Marfil blister	10	3,29 p/bag
B71211331	100005032	Marfil blister	12,5	3,07 p/bag
B71211309	100005015	Beige blister	10	3,29 p/bag
B71211327	100005029	Beige blister	12,5	3,07 p/bag
B71211310	100005016	Grey blister	10	3,29 p/bag
B71211328	100005030	Grey blister	12,5	3,07 p/bag

2 units per bag

pro-corner

Metallic profile for protecting corners.

Right angle, metallic profiles for protecting corners. Most of the pro-corner models are installed after the tile, which implies a small lip over the tile surface.

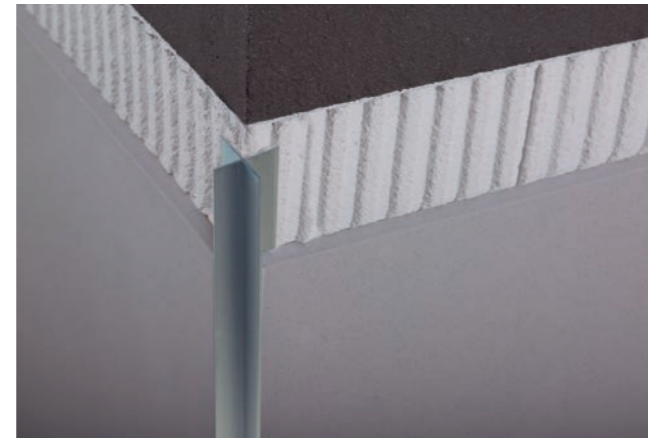
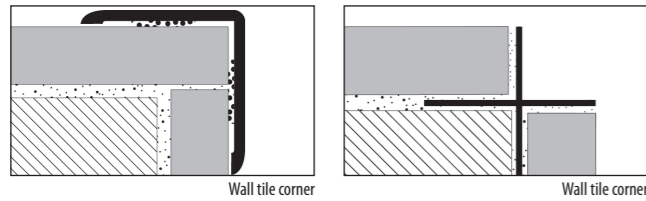

pro-corner P

Aluminium

KEA	SAP	h1 (mm)	h2 (mm)	P/EU	
B78141126	100158001	high gloss aluminum	15	12	91,29 p/u
B78141127	100158002	silver	15	12	80,58 p/u

Profile length: 2500 mm

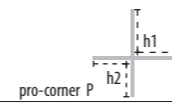

pro-corner mosaic

Aluminium

KEA	SAP	h (mm)	P/EU	
B78141122	100092530	high gloss aluminum	4.4	42,84 p/u
B78141123	100092529	anodized silver	4.4	25,50 p/u

Profile length: 2700 mm

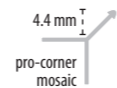

pro-corner R

Stainless steel

KEA	SAP	h (mm)	P/EU
B78141107	100005618	25	53,10 p/u
B78141109	100005620	40	78,76 p/u

Gloss stainless steel

KEA	SAP	h (mm)	P/EU
B78141112	100005623	25	53,10 p/u
B78141113	100005624	30	63,23 p/u
B78141114	100005625	40	78,76 p/u

Profile length: 2500 mm

Brushed stainless steel

KEA	SAP	h (mm)	P/EU
B78141117	100005628	25	53,10 p/u
B78141118	100005629	30	63,23 p/u

Longitud del perfil: 2500 mm

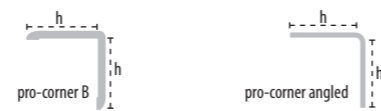

pro-corner aluminium

pro-corner B

KEA	SAP	h (mm)	P/EU
B78122001	100005584	25	23,49 p/u
B78122003	100005586	50	40,66 p/u

Profile length: 2500 mm

pro-corner angled

KEA	SAP	h (mm)	P/EU
B78122005	100005588	20	17,40 p/u
B78122006	100005589	25	15,62 p/u
B78122008	100005591	40	31,49 p/u

Profile length: 3000 mm

Minimum packaging: 10 profiles

XLIGHT Profiles

Corner profiles for wall tiles less than 6 mm thick. Specially recommended for mosaics and large format and thin ceramic slabs, such as XLIGHT.

Available in different shapes, from right-angled profiles for straight trims to rounded shape profiles. Decorative use.

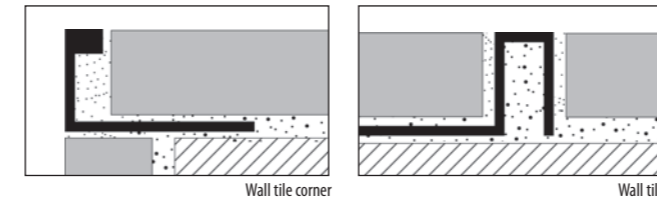

pro-mate 2

KEA	SAP	h (mm)	P/EU	
B71342617	100126769	V2A stainless steel	6	24,12 p/u



pro-mate 3

KEA	SAP	h (mm)	P/EU	
B71342608	100126772	chrome	6	49,88 p/u
B71342616	100126770	silver anodized	6	18,85 p/u
B71342609	100126771	white lacquer	6	14,18 p/u

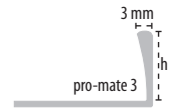

pro-mate 5

KEA	SAP	h (mm)	P/EU	
B71342611	100126779	XLIGHT	7	58,14 p/u

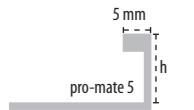

pro-part

KEA	SAP	h (mm)	P/EU	
B73134001	100005368	chrome	7	62,12 p/u
B73122001	100005322	silver anodized	7	14,99 p/u

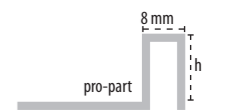

pro-part Li

KEA	SAP	h (mm)	a (mm)	P/EU	
B71342618	100126780	chrome	4.5	5.5	66,1 p/u
B71342619	100128227	silver anod	4.5	5.5	14,74 p/u

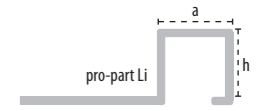

pro-mate 45 TOP

KEA	SAP	h (mm)	P/EU	
B71342614	100126778	chrome	6	60,18 p/u
B71342612	100126777	silver anodized	6	19,58 p/u



pro-mate 45

KEA	SAP	h (mm)	P/EU	
B71342615	100126776	chrome	6	63,24 p/u
B71342607	100126774	silver anodized	6	12,34 p/u
B71342610	100126773	white lacquer	6	15,31 p/u
B71342613	100126775	V2A stainless steel	6	27,97 p/u



Profile length: 2500 mm

Minimum packaging: 10 profiles



Technical profiles

pro-T

Profile for transitions between floor coverings.

Profiles for transitions between tiles or slabs with slightly different heights. Available in two widths: 14 and 25 mm
Specially recommended for transitions between ceramic tiles and wooden floors.

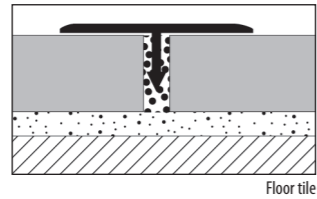

pro-T

Chromed brass

KEA	SAP	h (mm)	P/EU
B75133401	100005460	14	35,19 p/u
B75133402	100005461	25	52,21 p/u

Gloss stainless steel

KEA	SAP	h (mm)	P/EU
B75141003	100005462	14	34,76 p/u
B75141004	100005463	25	48,80 p/u

Anodized aluminium silver

KEA	SAP	h (mm)	P/EU
B75122001	100005452	14	7,76 p/u
B75122002	100005453	25	14,19 p/u

Gloss polished brass

KEA	SAP	h (mm)	P/EU
B75132001	100005458	14	25,40 p/u
B75132002	100005459	25	38,56 p/u

Brushed stainless steel

KEA	SAP	h (mm)	P/EU
B75141005	100005464	14	50,49 p/u
B75141006	100005465	25	65,07 p/u

pro-level

Transition profile between floor coverings at different levels. It covers the non-glazed edge of the tile and protects it from shocks.

Technical profiles for small height differences between floor coverings. Available in rounded finish and sloped finish. Specially recommended for high transit floors.

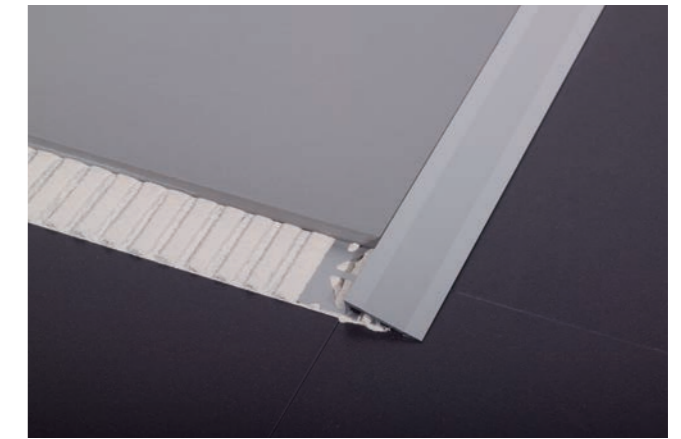
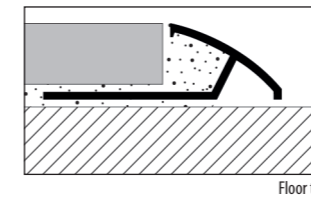
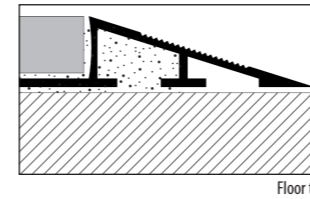

pro-level C



Anodized aluminium silver

KEA	SAP	h (mm)	P/EU
B74122001	100005425	9	16,33 p/u
B74122002	100005426	11	19,01 p/u
B74122003	100005427	12.5	25,44 p/u

Gloss polished brass

KEA	SAP	h (mm)	P/EU
B74132004	100005435	9	64,77 p/u
B74132006	100005437	12.5	67,63 p/u

pro-level R



Anodized aluminium silver

KEA	SAP	h (mm)	P/EU
B74122004	100005428	11	51,41 p/u
B74122005	100005429	12.5	56,50 p/u
B74122006	100005430	15	60,78 p/u
B74122007	100005431	20	66,94 p/u

pro-level M



Anodized aluminium

KEA	SAP	h (mm)	P/EU
B74132007	100120357	11	23,61 p/u

pro-shower

New range of profiles for shower trays. Designed to cover the sides of shower trays; specially for shower with only one direction slope. There are also special trims for installing glass screens.

These profiles are made of stainless steel and are available in two different finishings: gloss and brushed.

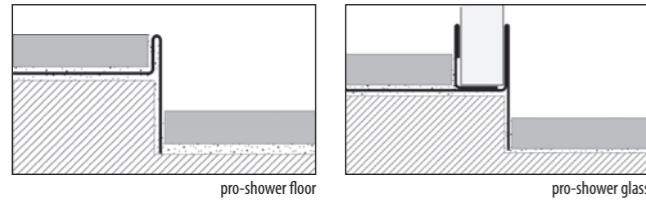

pro-shower floor

Chromed stainless steel

KEA	SAP		h (mm)	L (m)	P/EU
B77199022	100159068	Left side	12,5	0,98	77,47 p/u
B77199038	100160219	Right side	12,5	0,98	77,47 p/u
B77199025	100159069	Left side	12,5	1,48	122,35 p/u
B77199044	100160280	Right side	12,5	1,48	122,35 p/u

Brushed stainless steel

KEA	SAP		h (mm)	L (m)	P/EU
B77199021	100159066	Left side	12,5	0,98	66,20 p/u
B77199041	100160217	Right side	12,5	0,98	66,20 p/u
B77199020	100159067	Left side	12,5	1,48	101,85 p/u
B77199040	100160218	Right side	12,5	1,48	101,85 p/u

pro-shower wall

Chromed stainless steel

KEA	SAP		h (mm)	L (m)	P/EU
B77199033	100159089	Left side	12,5	0,98	77,47 p/u
B77199036	100160247	Right side	12,5	0,98	77,47 p/u
B77199034	100159100	Left side	12,5	1,48	122,35 p/u
B77199037	100160248	Right side	12,5	1,48	122,35 p/u

Brushed stainless steel

KEA	SAP		h (mm)	L (m)	P/EU
B77199031	100159087	Left side	12,5	0,98	66,20 p/u
B77199042	100160285	Right side	12,5	0,98	66,20 p/u
B77199032	100159088	Left side	12,5	1,48	101,85 p/u
B77199035	100160246	Right side	12,5	1,48	101,85 p/u

pro-shower glass

Chromed stainless steel

KEA	SAP		h (mm)	L (m)	P/EU
B77199028	100159092	Left side	12,5	0,98	144,05 p/u
B77199039	100160283	Right side	12,5	0,98	144,05 p/u
B77199023	100159093	Left side	12,5	1,48	203,85 p/u
B77199045	100160284	Right side	12,5	1,48	203,85 p/u
B77199027	100159095	Front side		2,10	305,95 p/u

Brushed stainless steel

KEA	SAP		h (mm)	L (m)	P/EU
B77199026	100159090	Left side	12,5	34	129,03 p/u
B77199043	100160281	Right side	12,5	34	129,03 p/u
B77199024	100159091	Left side	12,5	42	180,34 p/u
B77199046	100160282	Right side	12,5	42	180,34 p/u
B77199029	100159094	Front side		2,10	277,24 p/u

pro-balcony

Profiles for edging ceramic tile floors in terraces, balconies and other outdoor flooring. They protect the tile edges and avoid water filtrations both in floors and façades.

They have been designed to be used with lamitech n, the butech outdoor waterproofing and decoupling membrane. It also can be used as coping in bonded façades

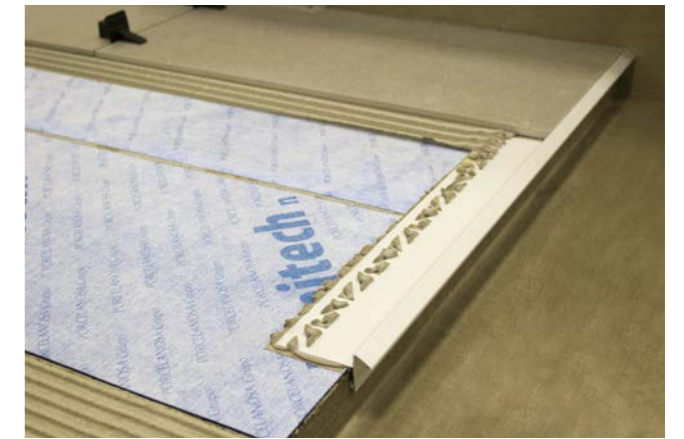
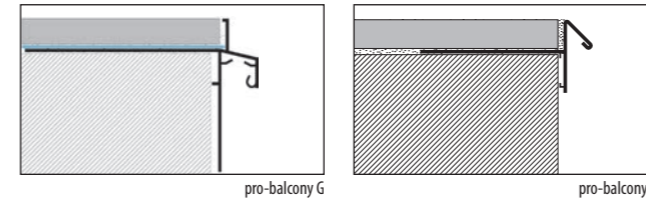

pro-balcony P

Anodized aluminum

KEA	SAP		h (mm)	P/EU
B79241146	100159112	Profile	11	45,39 p/u
B79241153	100159114	Outer corner	11	44,88 p/u
B79241152	100159116	Vertical inner corner	11	45,08 p/u
B79241151	100159113	Horizontal outer corner	11	17,14 p/u
B79241147	100159115	Vertical outer corner	11	20,81 p/u

pro-balcony G

Anodized aluminum

KEA	SAP		h (mm)	P/EU
B79241145	100159110	Profile	10,5	112,2 p/u
B79241148	100159111	corner	10,5	56,10 p/u

pro-balcony R

Anodized aluminum

KEA	SAP		h (mm)	P/EU
B79241150	100159117	Profile	12,5	104,04 p/u
B79241149	100159119	corner 90°	12,5	55,08 p/u
B79241154	100159118	corner 135°	12,5	65,79 p/u

Profile length: 3000 mm

pro-dilata

Profile for movement joints in ceramic floor coverings.

PVC or metal profiles with a central elastic joint for the absorption of tensions in the ceramic floor. Available in several colours and joint widths, they are the best solution for creating intermediate movement joints.

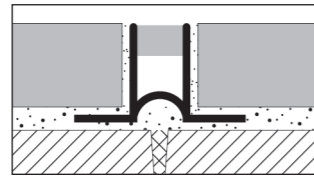

Floor tile

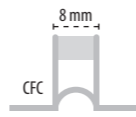
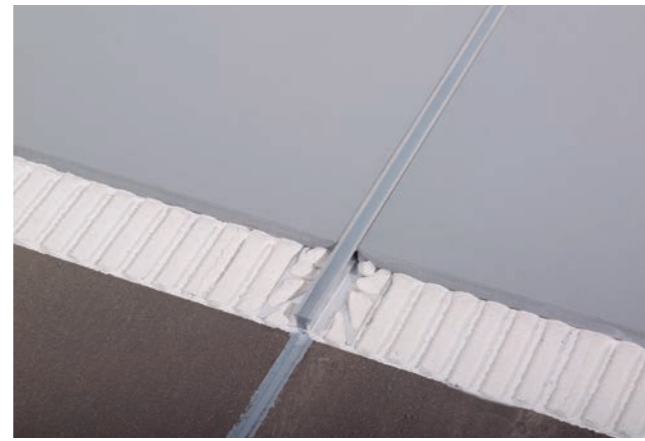

pro-dilata CFC

CFC 8 mm

KEA	SAP		h (mm)	P/EU
B79211037	100005673	Grey	8	6,89 p/u
B79211041	100005674	Grey	10	7,42 p/u
B79211045	100005675	Grey	12.5	7,68 p/u
B79211049	100005676	Grey	15	8,48 p/u

pro-dilata CFL

CFL 8 mm

KEA	SAP		h (mm)	P/EU
B79211058	100005685	White	12.5	15,11 p/u
B79211055	100005682	Beige	10	14,31 p/u
B79211059	100005686	Beige	12.5	15,11 p/u
B79211063	100005690	Beige	15	16,16 p/u
B79211056	100005683	Black	10	14,31 p/u
B79211060	100005687	Black	12.5	15,11 p/u
B79211064	100005691	Black	15	16,16 p/u
B79211057	100005684	Grey	10	14,31 p/u
B79211061	100005688	Grey	12.5	15,11 p/u
B79211065	100005692	Grey	15	16,16 p/u

CFL 5 mm

KEA	SAP		h (mm)	P/EU
B79211067	100005694	Grey	10	12,45 p/u
B79211068	100005695	Grey	12.5	12,98 p/u

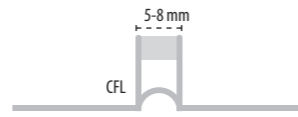

pro-dilata CFI

PVC 5 mm

KEA	SAP		h (mm)	P/EU
B79241142	100159078	light grey	11	12,75 p/u
B79241134	100159080	light grey	12.5	13,11 p/u
B79241143	100159076	grey	11	12,75 p/u
B79241136	100159077	grey	12.5	13,11 p/u
B79241135	100159081	Black	11	12,75 p/u
B79241133	100159082	Black	12.5	13,11 p/u
B79241144	100159074	ivory	11	12,75 p/u
B79241140	100159075	ivory	12.5	13,11 p/u

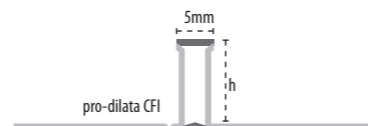

pro-dilata

New pro-dilata is a 5mm wide precast expansion joint for indoor ceramic floors.

pro-dilata corner in a precast expansion joint for the perimeter of ceramic tile floors. It's only 5mm wide and specially designed for fitting with the skirting pieces.

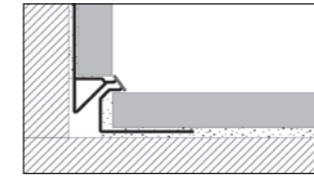

pro-dilata CFP

pro-dilata CFP

PVC CFP 5 mm

KEA	SAP		h (mm)	P/EU
B79241137	100159071	light gray	10	17,24 p/u
B79241138	100159070	grey	10	17,24 p/u
B79241139	100159073	black	10	17,24 p/u
B79241141	100159072	beige	10	17,24 p/u

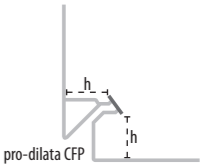
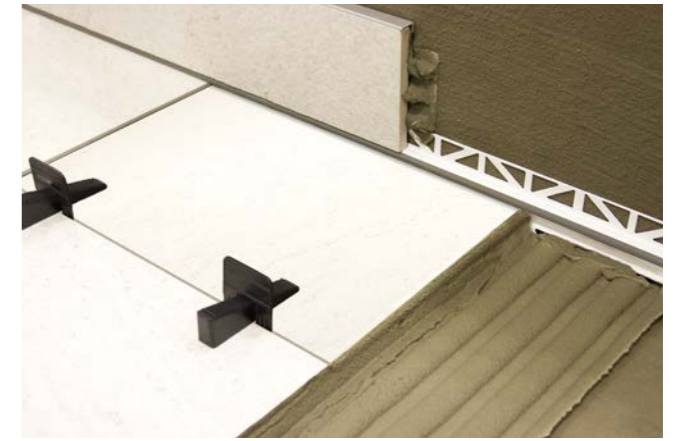

pro-dilata stainless steel

CFM 8 mm

KEA	SAP		h (mm)	P/EU
B79241089	100005713		8	70,40 p/u
B79241090	100005714		10	77,42 p/u
B79241091	100005715		12.5	83,86 p/u
B79241093	100005717		20	112,81 p/u
B79241094	100005718		25	118,65 p/u

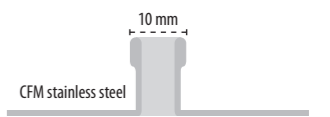

pro-dilata aluminium

CFM 10 mm

KEA	SAP		h (mm)	P/EU
B79221071	100005699		12.5	44,68 p/u
B79221072	100005700		15	50,61 p/u
B79221074	100005702		20	58,42 p/u

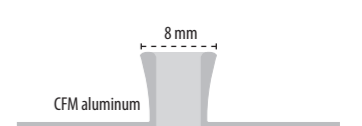

structural joints

Profile for structural joints in ceramic floor coverings.

Metallic profiles with a central elastic joint that absorbs the structural movements of the support. Available with deformable polypropylene joint for pedestrian transit and moving metallic joint for wheeled transit.

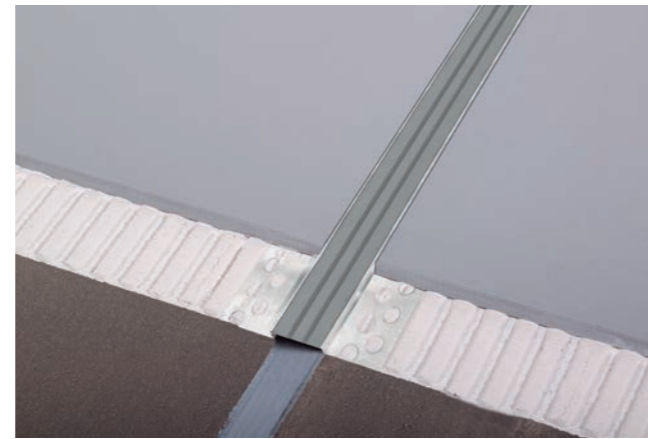
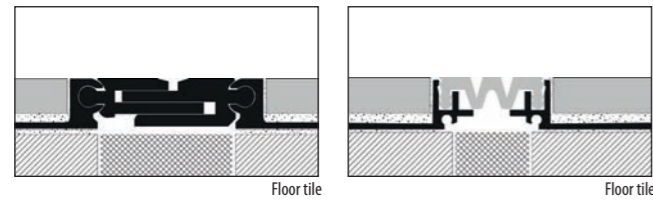

structural joints BT

BT-40

KEA	SAP		h (mm)	P/EU
B79241098	100044392	grey	18	101,95 p/ml
B79241099	100044393	grey	40	122,35 p/ml
B80106001	100005730	negro	18	101,95 p/ml
B80106003	100005732	negro	40	122,35 p/ml

structural joints AT

AT-75

KEA	SAP		h (mm)	P/EU
B80106004	100005733		18	143,97 p/ml
B79241105	100064650		35	152,21 p/ml
B80106002	100005731		50	235,78 p/ml

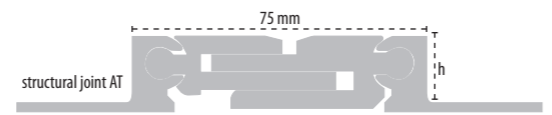

pro-dilata CK

CK Anodized aluminium

KEA	SAP		A (mm)	P/EU
B79241126	100140444		50	54,00 p/u
B79241122	100140445		60	64,80 p/u
B79241123	100140446		70	68,55 p/u

Corner pro-dilata CK

CK Anodized aluminium

KEA	SAP		A (mm)	P/EU
B79241128	100140448		50	55,08 p/u
B79241131	100140449		60	66,10 p/u
B79241129	100140450		70	69,92 p/u

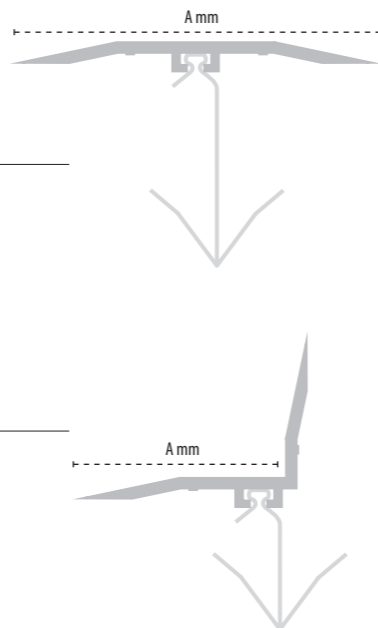

pro-step

Profile for the making of stair steps. It substitutes the traditional step ceramic piece by a combination of ceramic tile and profile.

Metallic profiles that cover the non-glazed edge of the tile, protect it from shocks and reduce the risk of slipping.

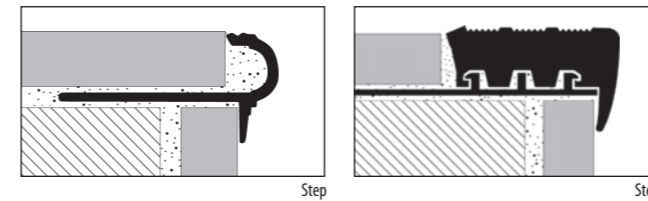

pro-step

Chromed brass M1

KEA	SAP		h (mm)	P/EU
B76334003	100005521		11	72,52 p/u

Stainless steel M2

KEA	SAP		h (mm)	P/EU
B76341001	100005522		9	46,56 p/u
B76341002	100005523		11	51,05 p/u

Gloss stainless steel M2

KEA	SAP		h (mm)	P/EU
B76342002	100005525		11	60,59 p/u

Anodized aluminium silver M1

KEA	SAP		h (mm)	P/EU
B76322001	100005507		7	19,83 p/u
B76322002	100005508		9	19,38 p/u
B76322003	100005509		11	20,40 p/u
B76342003	100067688		13.5	22,44 p/u

pro-step

PVC 25

KEA	SAP		h (mm)	P/EU
B76111026	100005493	White	11	34,71 p/u
B76111027	100005494	Beige	11	34,71 p/u
B76111028	100005495	Negro	11	34,71 p/u
B76111030	100005497	Grey	11	34,71 p/u

PVC 35

KEA	SAP		h (mm)	P/EU
B76111011	100005478	White	11	44,51 p/u
B76111013	100005480	Negro	11	44,51 p/u
B76111014	100005481	marrón	11	44,51 p/u
B76111015	100005482	Grey	11	44,51 p/u

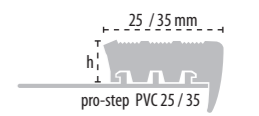

pro-flex

Flexible profiles for curve lines in floors.

Flexible profiles are available for installation in floor and wall tiles that form curves. They can be shaped with the **pro-curve** machine.

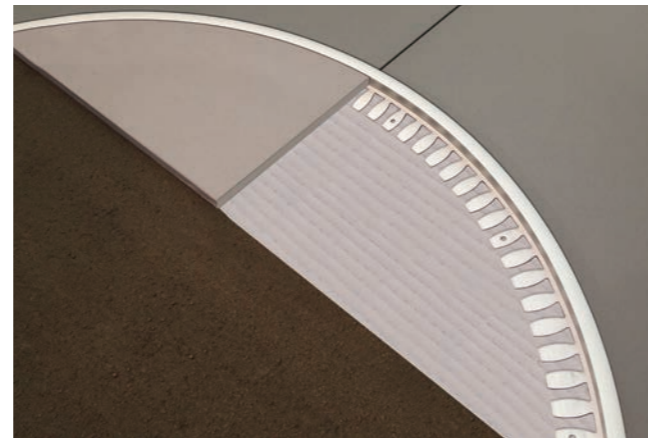
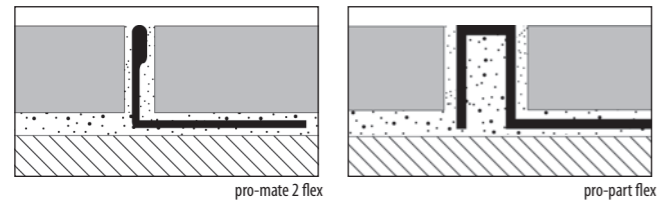

pro-flex



pro-mate 2 stainless steel V2A

KEA	SAP	h (mm)	P/EU
B71441002	100005223	10	27,77 p/u
B71441003	100005224	12.5	28,61 p/u

pro-mate 2 stainless steel gloss V2A

KEA	SAP	h (mm)	P/EU
B71442001	100005225	8	38,43 p/u
B71442002	100005226	10	39,83 p/u

pro-mate 3 anodized aluminium silver

KEA	SAP	h (mm)	P/EU
B71422001	100005179	8	12,59 p/u
B71422002	100005180	9	13,12 p/u
B71422003	100005181	10	13,39 p/u
B71422004	100005182	12.5	14,19 p/u
B71422005	100005183	15	15,53 p/u

pro-part gloss polished brass

KEA	SAP	h (mm)	P/EU
B73232003	100005413	11	59,06 p/u

pro-part anodized aluminium silver

KEA	SAP	h (mm)	P/EU
B73222001	100005390	7	17,40 p/u
B73222003	100005392	11	19,01 p/u
B73222004	100005393	12.5	20,61 p/u
B73222005	100005394	15	22,23 p/u
B73222006	100005395	20	23,83 p/u

pro-mate 45 anodized aluminium silver

KEA	SAP	h (mm)	P/EU
B71422106	100005194	10	15,80 p/u

pro-level C gloss polished brass

KEA	SAP	h (mm)	P/EU
B74232002	100005448	11	58,14 p/u
B74232003	100005449	12.5	70,38 p/u

pro-part anodized aluminium gold

KEA	SAP	h (mm)	P/EU
B73222011	100005400	12.5	21,15 p/u

pro-mate 45 anodized aluminium gold

KEA	SAP	h (mm)	P/EU
B71422107	100005195	10	15,80 p/u
B71422112	100005200	12.5	17,14 p/u

pro-level C anodized aluminium silver

KEA	SAP	h (mm)	P/EU
B74222002	100005442	11	21,42 p/u

pro-sanit

Concave profile for installation where walls and floors meet or between wall coverings and bathtubs, shower trays or other bath elements. It substitutes the traditional curve ceramic piece.

It reduces the risk of water leakage and eases cleaning and preservation of angles between floor and wall coverings.

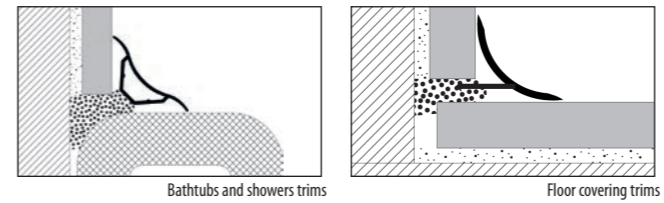

pro-sanit U1

Aluminium gloss silver

KEA	SAP	h (mm)	P/EU
B77199014	100062075	16	28,56 p/u
B77199018	100062076	22	32,59 p/u

Anodized aluminium silver

KEA	SAP	h (mm)	P/EU
B77199017	100062077	16	12,34 p/u
B77199015	100062078	22	15,45 p/u

Lacquered aluminium

KEA	SAP	h (mm)	P/EU	
B77199013	100062079	White	16	17,29 p/u
B77199016	100062080	White	22	21,62 p/u

PVC

KEA	SAP	h (mm)	P/EU	
B77111005	100005530	White	9	6,17 p/u
B77111008	100005533	Marfil	9	6,17 p/u

pro-sanit U2

Stainless steel

KEA	SAP	h (mm)	P/EU	
B77141001	100005566	gloss	12.5	50,78 p/u
B77142001	100005569	brushed	12.5	65,70 p/u

Stainless steel corner

KEA	SAP	h (mm)	P/EU	
B77141501	100005567	Gloss Outer	12.5	9,54 p/u
B77141502	100005568	Gloss Inner	12.5	9,54 p/u
B77142501	100005570	Brushed outer	12.5	9,54 p/u
B77142502	100005571	Brushed internal	12.5	9,54 p/u

PVC

KEA	SAP	h (mm)	P/EU	
B77111013	100005538	White	9x9	14,77 p/u
B77111017	100005542	White	11x9	16,33 p/u

pro-sanit S3

PVC

KEA	SAP	h (mm)	P/EU	
B77111035	100005560	White	23	5,18 p/u

Side cap

KEA	SAP	h (mm)	P/EU	
B77111038	100005563	White (4 u)	32	3,07 p/u

pro-plint

Metallic skirting for floor tile coverings.

Metallic profiles for skirtings. They have a high mechanical resistance with a functional, modern design. Specially recommended for office floors and raised access floors.

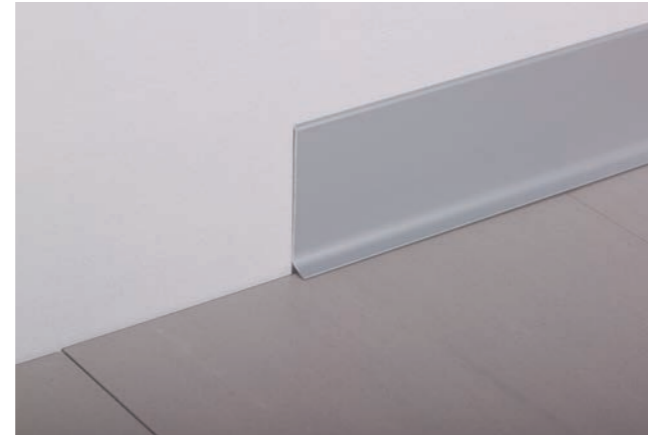
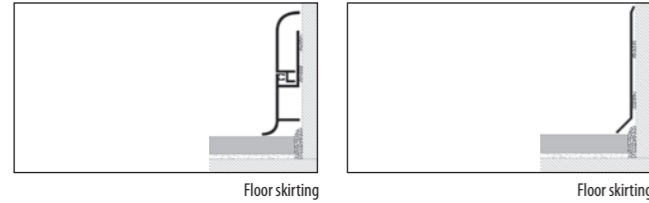

pro-plint stainless

Stainless steel

KEA	SAP		h (mm)	P/EU
B79141001	100005635	Gloss	80	36,06 p/u
B79141002	100005636	Brushed	80	46,72 p/u

pro-plint aluminium

Anodized aluminium

KEA	SAP		h (mm)	P/EU
B79141508	100073104	Silver	80	36,38 p/u

Special pieces

KEA	SAP		h (mm)	P/EU
B79141510	100073109	Profile joining piece	80	6,38 p/u
B79141511	100073107	Right trim	80	6,89 p/bag
B79141512	100073108	Left trim	80	4,08 p/bag

2 unit per bag

pro-plint aluminium R

Anodized aluminium

KEA	SAP		h (mm)	P/EU
B79123001	100005633	Base	80	44,37 p/u
B79123002	100005634	Top	80	25,19 p/u

pro-plint R consists of a base and a top profile.

Special pieces

KEA	SAP		h (mm)	P/EU
B79141507	100031428	Cap set	80	6,63 p/u

Includes right and left caps.



Pro-plint corner

KEA	SAP		h (mm)	P/EU
B79141509	100073106	Inner	80	6,60 p/bag
B79141513	100073105	Outer	80	5,46 p/bag

2 unit per bag



Pro-plint R corner

KEA	SAP		h (mm)	P/EU
B79141505	100007584	Outer	80	6,63 p/u
B79141506	100007585	Internal	80	6,63 p/u

pro-skirting

Metallic skirting for floor tile coverings.

Metal profiles in five finishes and straight trims. They replace traditional ceramic skirting. Specially recommended for shops and public buildings.

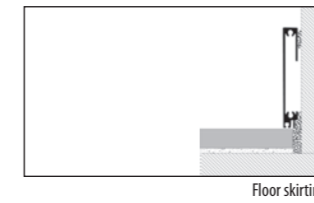

pro-skirting

Chromed aluminium

KEA	SAP	h (mm)	P/EU
B79141522	100120374	60	81,55 p/u

Profile length: 2500 mm

White lacquered aluminium

KEA	SAP	h (mm)	P/EU
B79141521	100120373	60	50,75 p/u

Profile length: 2500 mm

Anodized aluminium

KEA	SAP	h (mm)	P/EU
B79141527	100126826	60	48,86 p/u

Profile length: 2400 mm

graphite aluminium

KEA	SAP	h (mm)	P/EU
B71342627	100155326	60	101,75 p/u

Profile length: 2500 mm

Chromed aluminium corner

KEA	SAP	h (mm)	P/EU
B79141525	100121362	60	13,06 p/u

White lacquered aluminium corner

KEA	SAP	h (mm)	P/EU
B79141524	100121361	60	11,12 p/u

Anodized aluminium corner

KEA	SAP	h (mm)	P/EU
B79141526	100126827	60	9,44 p/u

graphite aluminium corner

KEA	SAP	h (mm)	P/EU
B71342626	100155327	60	13,06 p/u

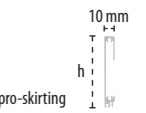



Adhesives for ceramic tile fixing

Cement-based adhesives

cerancol	76
tixocem	77
tixocem plus	78
flexitec n	79
fr-one n	81
fr-one especial	82
one-flex n	83
one-flex n sp	84
super-one n	85
super-flex S2	86
rapimax n	87
maxifluid	88

Dispersion adhesives

bt-3000 n	89
-----------	----

Reactive resins adhesive

politech n	90
------------	----

Additives for cement-based adhesives

unilax	91
fonolax	92

Façade fixings

concealed facade fixings	93
visible facade fixings	94

Selection tables for butech's adhesives

1. Once chosen the wall tile model, determine the type of ceramic material. Refer to the manufacturer's catalogue: PORCELANOSA, VENIS, URBATEK and L'ANTIC COLONIAL.

2. Search in the wall or floor tables, given the case, the adhesives which are compatible with the type of ceramic material chosen.

WALL	super-one n	super-flex S2	one-flex n	fr-one n	fr-one especial	bt-1000 n	bt-3000 n	flexitec n	tixocem +	tixocem	cerancol	politech n
Wall tile												
Large format wall tiles												
Glass mosaic												
Urbatek												
Ston-ker												
Par-ker												
Natural stone												
Water-sensitive stone												
XLIGHT			*	*	*							

FLOOR	super-one n	super-flex S2	one-flex n	fr-one n	fr-one especial	rapimax n	maxifluid	flexitec n	tixocem +	tixocem	cerancol	politech n
Stoneware tiles												
Porcelain tiles												
Urbatek												
Large format Urbatek												
Ston-ker												
Large format Ston-ker												
Par-ker												
Large format Par-ker												
Glass mosaic												
Natural stone												
Water-sensitive stone												
DQS	*											

3. Check which one of the compatible adhesives best matches its final use and substrate type.

SUBSTRATE / FINAL USE	SUBSTRATE / FINAL USE					SUBSTRATE / FINAL USE				
	Bathroom environment	Radiant heating	Outdoor floor	Façade	Pool	Mortar	Concrete	Plaster or Anhydrite	Plasterboard panels	Glazed ceramics
super-one n				*				**		
super-flex S2				*				**		
one-flex n				*				**		
fr-one n				*				**		
fr-one especial				*				**		
maxifluid								**		
rapimax n								**		
flexitec n								**		
tixocem +								**		
tixocem										
cerancol										
bt-1000 n										
bt-3000 n										
politech n										

4. Once you have chosen an adhesive which is compatible with the tile and its final use, check its features in this catalogue.

Given the wide variety of natural stones and glass mosaics from L'ANTIC COLONIAL, we recommend to check the material's scratch and stain resistance.

*: Mix with **unilax** additive.

** : Prime the substrate with **uniprim**

cerancol

cerancol is a cement-based adhesive, suitable for laying absorbent ceramic tiles indoors. Specially recommended for the installation of floor and wall coverings indoors, on cement-based supports.

It solves simply and effectively the laying of absorbent ceramic tiles indoors on cement-based supports. With this adhesive, tiles can be laid on a medium-bed layer on uneven substrates. It can be laid on thicknesses up to 12 mm. Suitable for tiles laid directly on brick partition walls.

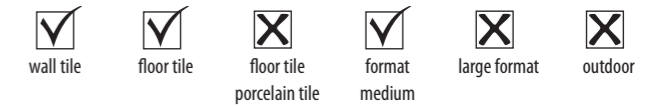

cerancol

Features:

- Cement-based, single component adhesive.
- Optimal workability. Thixotropic.
- Application thickness up to 12 mm.
- Mixing water: 6.0 - 6.5 l per 25 kg bag

Recommended uses:

- Medium and small format wall tile coverings for indoor use.
- Medium format floor tile coverings for indoor use.
- Uneven substrates.

Coverage:

- 20 x 30 cm tile 3 kg / m²
- 30 x 30 cm tile 3 kg / m²
- 30 x 60 cm tile 4 kg / m²
- 44 x 44 cm tile 4 kg / m²

Materials:

- Medium and small format ceramic tiles.
- Ceramic tiles with a water absorption > 0.5 % as per EN-ISO 10545-3.

Certifications/Standards:

EN 12004 Annex ZA

Substrates:

- Uncovered brick partition walls.
- Cement covered floors and walls.

cerancol

KEA	SAP		P/EU
B10903003	100004218	cerancol blanco	8,03 p/bag
B10904004	100004219	cerancol gris	7,25 p/bag

Packaging

Presentation	Europallet
25 kg bag	1,200 kg/pallet
25 kg bag	1,200 kg/pallet

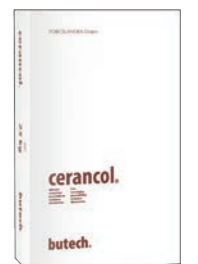

Before using this product in any application not indicated in this catalogue, please perform a test or refer to the product's technical sheet.

tixocem

tixocem is a type C1 T cement-based adhesive as per EN 12004, suitable for laying absorbent ceramic tiles using the thin-bed method, indoors and out. Its excellent conditions of use make it especially recommendable.

Single-component, high-tech adhesive for laying absorbent ceramic tiles. Excellent workability, easy to apply with extended working times. No sagging.

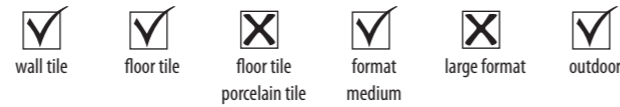

tixocem

Features:

- Cement-based, single component adhesive.
- Optimal workability. Thixotropic.
- Application thickness up to 6 mm.
- Frost-resistant.
- Mixing water: 6,0 l per 25 kg bag

Recommended uses:

- Medium and small format wall tile coverings for indoor use.
- Medium format floor tile coverings for indoor and outdoor use.

Coverage:

• 20 x 30 cm tile	3 kg / m ²
• 30 x 30 cm tile	3 kg / m ²
• 30 x 60 cm tile	4 kg / m ²
• 44 x 44 cm tile	4 kg / m ²
• 30 x 90 cm tile	5 kg / m ²
• 44 x 66 cm tile	5 kg / m ²

Materials:

- Medium and small format ceramic tiles.
- Ceramic tiles with a water absorption > 3 % as per EN-ISO 10545-3.

Certifications/Standards:

EN 12004 C1 T

Substrates:

- Cement covered floors and walls.

tixocem

KEA	SAP		P/EU
B11903003	100004220	tixocem blanco	9,06 p/bag
B11904004	100004221	tixocem gris	8,54 p/bag

Packaging

Presentation	Europallet
25 kg bag	1,400 kg/pallet
25 kg bag	1,400 kg/pallet



tixocem plus

tixocem plus is a type C1 TE cement-based adhesive as per EN 12004, suitable for laying absorbent ceramic tiles using the thin-bed method on cement, plasterboard substrates and for laying non-absorbent ceramic tiles on cement-based substrates. Specially recommended for laying porcelain tiles indoors.

It solves simply and effectively the laying of absorbent ceramic tiles on cement-based, plasterboard or brick supports. With this adhesive, tiles can be laid on a medium-bed layer on uneven substrates. It can be laid on thicknesses up to 10 mm. Waterproof and frost-resistant.



tixocem plus

Features:

- Cement-based, single component adhesive.
- Optimal workability. Thixotropic.
- Extended working times. Open time higher than 30 min.
- Application thickness up to 10 mm.
- Frost-resistant.
- Mixing water: 8 l per 25 kg bag

Recommended uses:

- Medium and small format wall tile coverings for indoor use.
- Medium format porcelain floor tile coverings for indoor use.
- Medium format floor tile coverings for indoor and outdoor use.
- Uneven substrates.

Coverage:

• 20 x 30 cm tile	3 kg / m ²
• 30 x 30 cm tile	3 kg / m ²
• 30 x 60 cm tile	4 kg / m ²
• 44 x 44 cm tile	4 kg / m ²
• 30 x 90 cm tile	5 kg / m ²
• 44 x 66 cm tile	5 kg / m ²

Materials:

- Medium and small format ceramic tiles.
- Absorbent and non-absorbent ceramic tiles.
- Porcelain tiles with a water absorption < 0.5 % as per EN-ISO 10545-3.

Certifications/Standards:

EN 12004 C1 TE

Substrates:

- Uncovered brick partition walls.
- Cement covered floors and walls .
- Plasterboards.
- On anhydrite or plaster substrates apply **uniprim**.

tixocem plus

KEA	SAP		P/EU
B11906007	100043280	tixocem plus blanco	11,35 p/bag

Packaging

Presentation	Europallet
25 kg bag	1,200 kg/pallet



flexitec n

flexitec n is a type C2 TE cement-based adhesive, suitable for laying porcelain tiles, on cement-based substrates or flexible substrates like plasterboard. Its excellent conditions of use make it especially recommendable.

A medium-elasticity cement-based adhesive for laying absorbent ceramic tiles, stone-ware or porcelain tiles using the thin-bed method. Thixotropic.



Porcelain floor tiles



flexitec n

Features:

- Cement-based, single component adhesive.
- Excellent adherence. Medium flexibility.
- Fine texture mortar, with excellent mixing and application features.
- High initial adherence and no sagging.
- Extended working times. Open time higher than 30 min.
- Application thickness up to 6 mm.
- Frost-resistant.
- Mixing water:
 - White: 7,25 - 7,75 l per 25 kg bag
 - Grey: 6,75 - 7,25 l per 25 kg bag

Coverage:

• 20 x 30 cm tile	3 kg / m ²
• 30 x 30 cm tile	3 kg / m ²
• 30 x 60 cm tile	4 kg / m ²
• 44 x 44 cm tile	4 kg / m ²
• 30 x 90 cm tile	5 kg / m ²
• 44 x 66 cm tile	5 kg / m ²

Certifications/Standards:

Certifié CSTB Certified: CSTB 1061-222 MC 299
EN 12004 C2 TE

flexitec n

KEA	SAP		P/EU
B12902003	100004232	flexitec n blanco	0,83 p/kg
B12901002	100004230	flexitec n gris	0,79 p/kg

Recommended uses:

- Indoor wall tile coverings.
- Indoor and outdoor porcelain tile coverings.

Materials:

- Large format absorbent ceramic tiles.
- Medium format non-absorbent ceramic tiles.
- Porcelain tiles with a water absorption < 0.5% as per EN-ISO 10545-3.

Substrates:

- Cement covered floors and walls .
- Concrete slabs.
- Plasterboards.
- On anhydrite or plaster substrates apply **uniprim**.

Packaging

Presentation	Europallet
25 kg bag	1,000 kg/pallet
25 kg bag	1,000 kg/pallet



fr-one n

fr-one n is a type C2 TE high-tech cement-based adhesive, as per EN 12004, for laying all kinds of ceramic tiles on the most used substrates in the building industry. Specially recommended for large format tiles and uneven substrates.

Advanced, high-performance, single-component, easy to use adhesive for laying all kinds of ceramic tiles. With this adhesive, tiles can be laid on a medium-bed layer on uneven substrates. It can be laid on thicknesses up to 15 mm. Specially recommended for porcelain floor tiles, antiqued marble, large formats and pools. Thixotropic.



fr-one n

Features:

- Cement-based, single component adhesive.
- Excellent adherence.
- Optimal workability. Extended working times. Open time higher than 30 min.
- High initial adherence and no sagging.
- Application thickness up to 15 mm.
- Frost-resistant.
- Mixing water: 7.25 - 7.75 l per 25 kg bag

Recommended uses:

- Indoor large format ceramic tile coverings.
- Indoor and outdoor porcelain tile coverings.
- Uneven substrates.
- High traffic floor tiles.
- Floor tiles on radiant heating.
- Pools and damp environments.
- On bonded facades, replace mixing water with **unilax** additive.

Coverage:

• 20 x 30 cm tile	3 kg / m ²
• 30 x 30 cm tile	3 kg / m ²
• 30 x 60 cm tile	4 kg / m ²
• 44 x 44 cm tile	4 kg / m ²
• 30 x 90 cm tile	5 kg / m ²
• 44 x 66 cm tile	5 kg / m ²
• 60 x 60 cm tile	6 kg / m ²
• 60 x 120 cm tile	6 kg / m ²

Materials:

- Large format ceramics.
- Porcelain tiles (water absorption < 0.5% as per EN-ISO 10545-3).
- Glass mosaic.
- Natural stone and marble not prone to staining.

Substrates:

- Cement covered floors and walls .
- Concrete slabs.
- Plasterboards.
- Existing wall tiles*.
- On anhydrite or plaster substrates apply **uniprim**.

Packaging

Presentation	Europallet
25 kg bag	1,000 kg/pallet
25 kg bag	1,000 kg/pallet



fr-one n

KEA	SAP	P/EU
B12906008	100004241	fr-one n blanco
B12907009	100004244	fr-one n gris

* **super-prim** improves the adherence on polished ceramics and glossy finishing tiles

Before using this product in any application not indicated in this catalogue, please perform a test or refer to the product's technical sheet.

fr-one especial

fr-one especial is a type C2 TE cement-based adhesive, as per EN 12004, highly resistant to sulfates, for laying all kinds of ceramic tiles on the most used substrates in the building industry. Excellent workability.

Advanced, high-performance, single-component, easy to use adhesive for laying all kinds of ceramic tiles. Specially recommended for plaster or anhydrite substrates without the need for previous priming.

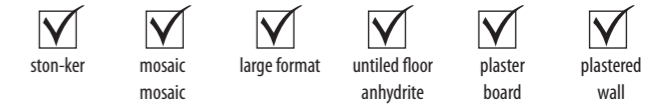
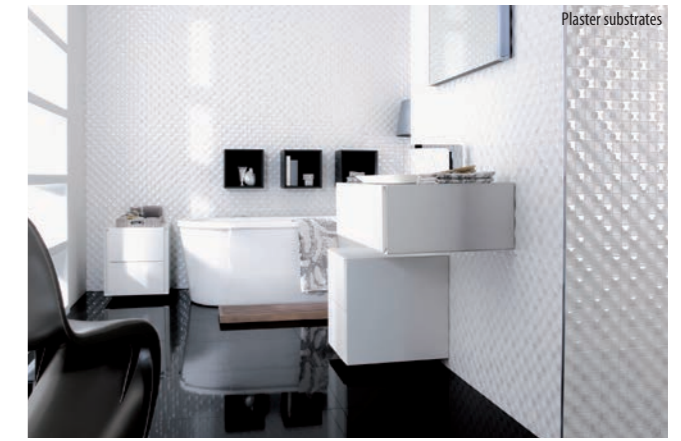

fr-one especial

Features:

- Cement-based, single component adhesive.
- Resistant to sulfates. Suitable for plaster or anhydrite substrates without the need for priming.
- Excellent adherence.
- Optimal workability. Extended working times. Open time higher than 30 min.
- High initial adherence and no sagging.
- Application thickness up to 10 mm.
- Frost-resistant.
- Mixing water: 8.0 - 8.25 l per 25 kg bag

Recommended uses:

- Indoor large format ceramic tile coverings.
- Indoor and outdoor porcelain tile coverings.
- High traffic floor tiles.
- Floor tiles on radiant heating.
- Pools and damp environments.
- On bonded facades, replace mixing water with **unilax** additive.

Coverage:

• 20 x 30 cm tile	3 kg / m ²
• 30 x 30 cm tile	3 kg / m ²
• 30 x 60 cm tile	4 kg / m ²
• 44 x 44 cm tile	4 kg / m ²
• 30 x 90 cm tile	5 kg / m ²
• 44 x 66 cm tile	5 kg / m ²
• 60 x 60 cm tile	6 kg / m ²
• 60 x 120 cm tile	6 kg / m ²

Materials:

- Large format ceramics.
- Porcelain tiles (water absorption < 0.5% as per EN-ISO 10545-3).
- Glass mosaic.
- Natural stone and marble not prone to staining.

Certifications/Standards:

EN 12004 C2 TE

Substrates:

- Anhydrite floors.
- Plasterboards and plastered walls.
- Cement covered floors and walls .
- Concrete floors and slabs.
- Plasterboards.
- Existing wall tiles*.

fr-one especial

KEA	SAP	P/EU
B12909015	100079263	fr-one especial blanco

Packaging

Presentation	Europallet
25 kg bag	1,000 kg/pallet



* **super-prim** improves the adherence on polished ceramics and glossy finishing tiles

Before using this product in any application not indicated in this catalogue, please perform a test or refer to the product's technical sheet.

one-flex n

one flex n is a type C2 TE S1 high-performance cement-based adhesive, as per EN 12004, for laying all kinds of ceramic tiles on the most used substrates in the building industry.

Advanced, high-performance adhesive, with an excellent adherence and flexibility, suitable for the most difficult installations, like high traffic floors, radiant heating floors or facades. Its performance and ease of application make it the ideal solution for the most demanding professionals. Specially recommended for laying rectified tiles.

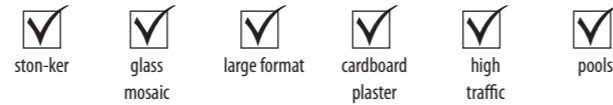

one-flex n

Features:

- Cement-based, single component adhesive.
- Excellent adherence. Flexible.
- Fine texture mortar, with excellent mixing and application features.
- High initial adherence and no sagging.
- Extended working times. Open time higher than 30 min.
- Application thickness up to 6 mm.
- Frost-resistant.

Mixing water: white: 8.25 - 8.75 l per 25 kg bag
grey: 7.75 - 8.25 l per 25 kg bag

Coverage:

• 20 x 30 cm tile	3 kg / m ²
• 30 x 30 cm tile	3 kg / m ²
• 30 x 60 cm tile	4 kg / m ²
• 44 x 44 cm tile	4 kg / m ²
• 30 x 90 cm tile	5 kg / m ²
• 44 x 66 cm tile	5 kg / m ²
• 60 x 60 cm tile	6 kg / m ²
• 60 x 120 cm tile	6 kg / m ²

Certifications/Standards:

Certifié CSTB Certified: CSTB 1061-222 MC 300
EN 12004 C2 TE S1

one-flex n

KEA	SAP		P/EU
B12903004	100004234	one-flex n blanco	1,01 p/kg
B12904005	100004236	one-flex n gris	0,94 p/kg

Recommended uses:

- Indoor large format ceramic tile coverings.
- Indoor and outdoor porcelain tile coverings.
- High traffic floor tiles.
- Floor tiles on radiant heating.
- Pools and damp environments.
- On bonded facades, replace mixing water with **unilax** additive.
- Especially recommended for meshed glass mosaics from L'ANTIC COLONIAL in dry areas.

Materials:

- Large format ceramics.
- Porcelain tiles with a water absorption < 0.5% as per EN-ISO 10545-3.
- Glass mosaic.
- Natural stone and marble not prone to staining.

Substrates:

- Cement covered floors and walls .
- Concrete slabs.
- Plasterboards.
- Existing wall tiles*.
- On anhydrite or plaster substrates apply **uniprim**.

Packaging

Presentation	Europallet
25 kg bag	1,000 kg/pallet
25 kg bag	1,000 kg/pallet



* **super-prim** improves the adherence on polished ceramics and glossy finishing tiles

Before using this product in any application not indicated in this catalogue, please perform a test or refer to the product's technical sheet.

one-flex n sp

one flex n sp is a type C2 TE S1 high-performance no dust cement-based adhesive, as per EN 12004, for laying all kinds of ceramic tiles on the most used substrates in the building industry. It generates a minimum amount of dust.

Advanced, high-performance adhesive, with an excellent adherence and flexibility, suitable for the most difficult installations, like high traffic floors, radiant heating floors or facades. Its performance and ease of application make it the ideal solution for the most demanding professionals. Specially recommended for laying rectified tiles.

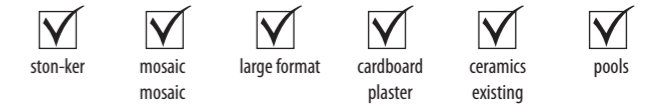

one-flex n sp

Features:

- Cement-based, single component adhesive.
- Low emission of dust and other airborne particles.
- Excellent adherence. Flexible.
- Fine texture mortar, with excellent mixing and application features.
- High initial adherence and no sagging.
- Extended working times. Open time higher than 30 min.
- Application thickness up to 6 mm.
- Frost-resistant.

Mixing water: 7.5 l per 25 kg bag

Coverage:

• 20 x 30 cm tile	3 kg / m ²
• 30 x 30 cm tile	3 kg / m ²
• 30 x 60 cm tile	4 kg / m ²
• 44 x 44 cm tile	4 kg / m ²
• 30 x 90 cm tile	5 kg / m ²
• 44 x 66 cm tile	5 kg / m ²
• 60 x 60 cm tile	6 kg / m ²
• 60 x 120 cm tile	6 kg / m ²

Certifications/Standards:

EN 12004 C2 TE S1

one-flex n sp

KEA	SAP		P/EU
B12909013	100061979	one-flex n blanco sp	1,17 p/kg
B12909012	100061980	one-flex n gris sp	1,08 p/kg

Recommended uses:

- Laying of ceramics in refurbishing jobs.
- Indoor large format ceramic tile coverings.
- Indoor and outdoor porcelain tile coverings.
- High traffic floor tiles.
- Floor tiles on radiant heating.
- Pools and damp environments.
- On bonded facades, replace mixing water with **unilax** additive.

Materials:

- Large format ceramics.
- Porcelain tiles with a water absorption < 0.5% as per EN-ISO 10545-3.
- Glass mosaic.
- Natural stone and marble not prone to staining.

Substrates:

- Cement covered floors and walls .
- Concrete slabs.
- Plasterboards.
- Existing wall tiles*.
- On anhydrite or plaster substrates apply **uniprim**.

Packaging

Presentation	Europallet
25 kg bag	1,000 kg/pallet
25 kg bag	1,000 kg/pallet



* **super-prim** improves the adherence on polished ceramics and glossy finishing tiles

Before using this product in any application not indicated in this catalogue, please perform a test or refer to the product's technical sheet.

super-one n

super-one n is a type C2 FTE S1 high-performance cement-based adhesive, as per EN 12004, ready for traffic after 4 hours. Specially recommended for quick installation and use of ceramic tiles and natural stone.

It solves the need of quick installation of any kind of format and ceramic tile, including porcelain tiles. Ready for traffic in just 4 hours, this adhesive can be used to lay ceramic tiles and natural stone in environments where high mechanical performance is needed, such as commercial or industrial flooring or flooring with radiant heating. Waterproof and frost-resistant.



super-one n

Features:

- Cement-based, single component adhesive.
- Ready for traffic in just 4 hours.
- Excellent adherence. Flexible.
- Fine texture mortar, with excellent mixing and application features.
- High initial adherence and no sagging.
- Extended working times. Open time higher than 30 min.
- Application thickness up to 10 mm.
- Frost-resistant.
- Mixing water: 6.0 - 6.50 l per 25 kg bag

Coverage:

• 20 x 30 cm tile	3 kg / m ²
• 30 x 30 cm tile	3 kg / m ²
• 30 x 60 cm tile	4 kg / m ²
• 44 x 44 cm tile	4 kg / m ²
• 30 x 90 cm tile	5 kg / m ²
• 44 x 66 cm tile	5 kg / m ²
• 60 x 60 cm tile	6 kg / m ²
• 60 x 120 cm tile	6 kg / m ²

Certifications/Standards:

Certifié CSTB Certified: CSTB 1092-228 MC 312
EN 12004 C2 FT S1

super-one n

KEA	SAP		P/EU
B12909010	100031188	super-one n blanco	1,45 p/kg
B12909011	100031189	super-one n gris	0,99 p/kg

Recommended uses:

- Laying of ceramics in refurbishing jobs.
- Indoor large format ceramic tile coverings.
- Indoor and outdoor porcelain tile coverings.
- Plywood substrates.
- High traffic floor tiles.
- Floor tiles on radiant heating.
- Pools and damp environments.
- On bonded facades, replace mixing water with **unilax** additive.
- Especially recommended for white marble tiles from L'ANTIC COLONIAL

Materials:

- Large format ceramics.
- Porcelain tiles with a water absorption < 0.5% as per EN-ISO 10545-3.
- Glass mosaic.
- Natural stones and marble without risk of deformation by water absorption.
- In installations of DQS slabs and other kinds of marble agglomerate, mix with **unilax** latex.

Substrates:

- Cement covered floors and walls.
- Concrete slabs.
- Plasterboards.
- On **fonopac r** replace mixing water with **fonolax**.
- Existing wall tiles*.
- On anhydrite or plaster substrates apply **uniprim**.

Packaging

Presentation	Europallet
25 kg bag	1,000 kg/pallet
25 kg bag	1,000 kg/pallet



* **super-prim** improves the adherence on polished ceramics and glossy finishing tiles

Before using this product in any application not indicated in this catalogue, please perform a test or refer to the product's technical sheet.

super-flex S2

super-flex S2 is a type C2 E S2 high-performance no dust cement-based adhesive, as per EN 12004, for laying all kinds of ceramic tiles on the most used substrates in the building industry. Specially recommended for laying large format, thin porcelain tiles like XLIGHT from URBATEK.

This adhesive features excellent performance in adherence and deformability with no need for mixing with additives and excellent conditions of use: low dust generation and an only 15 kg package. This state-of-the-art adhesive includes additives and polymers which increase performance. This means that with a 15 kg bag of super-flex S2 you can lay the same tiles surface than with a 25 kg bag of regular adhesive.



super-flex S2

Features:

- Cement-based, single component adhesive.
- Lightened adhesive. Low consumption onsite.
- Low emission of dust and other airborne particles.
- Maximum adherence and deformability.
- High initial adherence and no sagging. Thixotropic.
- Extended working times. Open time higher than 30 min.
- Application thickness up to 10 mm.
- Frost-resistant.
- Mixing water: 8 l per 15 kg bag

Coverage:

• 20 x 30 cm tile	2.00 kg / m ²
• 30 x 30 cm tile	2.00 kg / m ²
• 30 x 60 cm tile	2.50 kg / m ²
• 44 x 44 cm tile	2.50 kg / m ²
• 30 x 90 cm tile	3.00 kg / m ²
• 44 x 66 cm tile	3.00 kg / m ²
• 60 x 60 cm tile	3.50 kg / m ²
• 60 x 120 cm tile	3.50 kg / m ²
• 100 x 100 cm tile	3.50 kg / m ²
• 100 x 300 cm tile	3.50 kg / m ²

Certifications/Standards:

EN 12004 C2 E S2

Super-flex S2

KEA	SAP		P/EU
B12909017	100142757	super-flex S2 white	2,84 p/kg

Recommended uses:

- Indoor coverings with ceramic sheets like XLIGHT.
- Laying of ceramics in refurbishing jobs.
- Indoor large format ceramic tile coverings.
- Indoor and outdoor porcelain tile coverings.
- High traffic floor tiles.
- Floor tiles on radiant heating.
- Pools and damp environments.
- Especially recommended for XLIGHT tiles from URBATEK.
- Suitable for DQS from L'ANTIC COLONIAL in areas not exposed to direct sunlight.

Materials:

- Large format ceramics.
- Porcelain tiles (water absorption < 0.5% as per EN-ISO 10545-3).
- Large format, thin porcelain tiles like XLIGHT.
- Glass mosaic.
- Natural stone and marble not prone to staining.
- DQS slabs and other kinds of marble agglomerate.

Substrates:

- Cement covered floors and walls.
- Concrete slabs.
- Plasterboards.
- Existing wall tiles*.
- On anhydrite or plaster substrates apply **uniprim**.

Packaging

Presentation	Europallet
15 kg bag	600 kg/pallet



* **super-prim** improves the adherence on polished ceramics and glossy finishing tiles

Before using this product in any application not indicated in this catalogue, please perform a test or refer to the product's technical sheet.

rapimax n

rapimax n is a type C2 E high-tech cement-based adhesive, as per EN 12004, for laying all kinds of ceramic tiles on floors. Its high wettability and fluidity ensure full coverage of the underside of tiles without having to resort to the floating and buttering method.

A high-performance fluid adhesive for laying void-free ceramic floors. Specially recommended for porcelain floor tiles, terracotta and large formats. Indoors and outdoors.



rapimax n

Features:

- Cement-based, single component adhesive.
- A fluid mortar, applicable with a notched trowel, that under the tile pressure, flows and covers the whole back of the tile.
- Excellent adherence.
- Extended working times. Open time higher than 30 min.
- Application thickness up to 10 mm.
- Frost-resistant.
- Mixing water: 5.0 - 5.5 l per 25 kg bag

Recommended uses:

- Indoor and outdoor porcelain tile coverings.
- Large format porcelain floors.
- High traffic floor tiles.
- Floor tiles with radiant heating.
- Laying of tiles on glazed floor tiles.
- Never use in walls.

Coverage:

- | | |
|--------------------|-----------------------|
| • 30 x 30 cm tile | 4 kg / m ² |
| • 44 x 44 cm tile | 5 kg / m ² |
| • 44 x 66 cm tile | 5 kg / m ² |
| • 60 x 60 cm tile | 6 kg / m ² |
| • 60 x 120 cm tile | 6 kg / m ² |

Materials:

- Large format ceramics.
- Porcelain tiles with a water absorption < 0.5% as per EN-ISO 10545-3.
- Clay and terracotta.
- Natural stone and marble not prone to staining.

Certifications/Standards:

EN 12004 C2 E

Substrates:

- Cement covered floors.
- Concrete covered floors.
- Existing floor tiles*.
- On anhydrite or plaster floors apply **uniprim**.

rapimax n

KEA	SAP	P/EU
B12905006	100004238	rapimax n gris 0,89 p/kg

Packaging

Presentation	Europallet
25 kg bag	1,000 kg/pallet



* **super-prim** improves the adherence on polished ceramics and glossy finishing tiles

Before using this product in any application not indicated in this catalogue, please perform a test or refer to the product's technical sheet.

maxifluid

maxifluid is a type C2 E S1 high-performance cement-based adhesive, as per EN 12004, for laying all kinds of ceramic tiles on floors. Its high wettability and fluidity ensure full coverage of the underside of tiles without having to resort to the floating and buttering method.

A high-performance fluid, flexible adhesive for laying void-free ceramic floors. Specially recommended for porcelain floor tiles, terracotta and large formats. Indoors and outdoors.

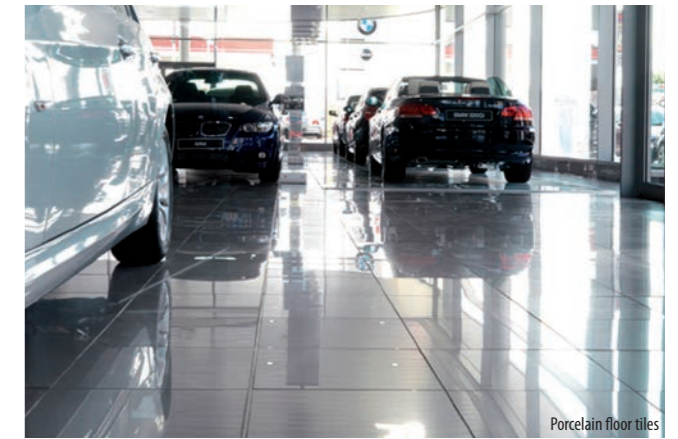

maxifluid

Features:

- Cement-based, single component adhesive.
- A fluid mortar, applicable with a notched trowel, that under the tile pressure, flows and covers the whole back of the tile.
- Excellent adherence.
- Flexible.
- Extended working times. Open time higher than 30 min.
- Application thickness up to 10 mm.
- Frost-resistant.
- Mixing water: 5.0 - 5.5 l per 25 kg bag

Recommended uses:

- Indoor and outdoor porcelain tile coverings.
- Large format porcelain floors.
- High traffic floor tiles.
- Floor tiles with radiant heating.
- Laying of tiles on glazed floor tiles.
- Never use for wall tiles.
- Especially recommended for large format floor tiles from STON-KER, URBATEK and PAR-KER.

Coverage:

- | | |
|--------------------|-----------------------|
| • 30 x 30 cm tile | 4 kg / m ² |
| • 44 x 44 cm tile | 5 kg / m ² |
| • 44 x 66 cm tile | 5 kg / m ² |
| • 60 x 60 cm tile | 6 kg / m ² |
| • 60 x 120 cm tile | 6 kg / m ² |

Materials:

- Large format ceramics.
- Porcelain tiles with a water absorption < 0.5% as per EN-ISO 10545-3.
- Clay and terracotta.
- Natural stone and marble not prone to staining.

Certifications/Standards:

EN 12004 C2 E S1

Substrates:

- Cement covered floors.
- Concrete covered floors.
- Existing floor tiles*.
- On anhydrite or plaster floors apply **uniprim**.

maxifluid

KEA	SAP	P/EU
B11906008	100033113	maxifluid gris 0,92 p/kg

Packaging

Presentation	Europallet
25 kg bag	1,000 kg/pallet



* **super-prim** improves the adherence on polished ceramics and glossy finishing tiles

Before using this product in any application not indicated in this catalogue, please perform a test or refer to the product's technical sheet.

bt-3000 n

bt-3000n is a type D2 TE dispersion adhesive, as per EN 12004, for laying all kinds of ceramic tiles on indoor walls. This adhesive is served ready-to-use and does not need any water or additives. Specially recommended for installation on plasterboard substrates, even in highly damp environments or wall tiles into direct contact with water.

A flexible ready-to-use adhesive paste. Suitable for laying all types of indoor ceramic tiles. Specially recommended in damp areas.



bt-3000 n

Features:

- Ready-to-use dispersion adhesive.
- Excellent adherence. Flexible.
- Resistant to dampness.
- Fine texture adhesive, with excellent mixing and application features.
- High initial adherence and no sagging.
- Extended working times. Open time higher than 30 min.
- Application thickness up to 4 mm.

Recommended uses:

- Wall tile on dry partition wall: plasterboard.
- Wall tile on plaster.
- Indoor ceramic tile coverings.
- Indoor wall tiles in permanently damp environments.
- Indoor decoration with ceramics: bath or kitchen countertops.
- Never use for floor tiles.

Coverage:

- 20 x 20 cm tile 3 kg / m²
- 20 x 30 cm tile 3 kg / m²
- 30 x 60 cm tile 4 kg / m²

Materials:

- Medium and small format ceramic tiles or slabs.
- Small format porcelain tiles (water absorption < 0.5% as per EN-ISO 10545-3).
- Glass mosaic.
- Isolating panels:
 - EPS panels.
 - PS panels.
 - Mineral wool panels.

Certifications/Standards:

EN 12004 D2 TE
Certifié CSTB Certified 84 AD 281: D2E

Substrates:

- Cement screed.
- Plasterboards and plaster or anhydrite walls.
- Plasterboards.
- Plywood boards.
- Existing wall tiles*.

bt-3000 n

KEA	SAP	P/EU
B13903003	100031163	bt-3000 n 1,64 p/kg

Packaging

Presentation	Europallet
25 kg can	600 kg/pallet



* Existing wall tiles, provided the new tile has a water absorption >10% as per EN-ISO 10545-3. **super-prim** improves the adherence on polished ceramics and glossy finishing tiles

Before using this product in any application not indicated in this catalogue, please perform a test or refer to the product's technical sheet.

politech n

politech is a type R2 T high-tech, two-component polyurethane adhesive as per EN 12004, for laying tiles on deformable substrates. Specially recommended for special substrates like metal sheets or synthetic materials, where cement-based adhesives cannot be used.

A high-tech two-component polyurethane adhesive with high performance properties. Suitable for laying ceramic tiles of all kinds on deformable substrates.

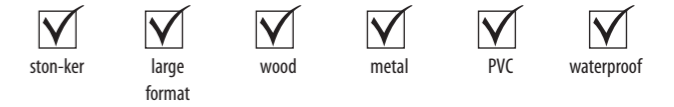

politech n

Features:

- Two-component polyurethane adhesive.
- Excellent adherence. Maximum deformability.
- No water absorption. Waterproof.
- High chemical resistance.
- High initial adherence and no sagging.
- Application thickness up to 8 mm.
- Frost-resistant.

Recommended uses:

- Laying of wall tiles not compatible with cement-based adhesives.
- Wall tiles on substrates not compatible with cement-based adhesives.
- Floor tiles on deformable substrates.
- Floor tiles with special chemical resistance.
- Laying of slate and other natural stones with risk of deformation by water absorption.
- Substrate waterproofing.
- Suitable for AIRSLATE from L'ANTIC COLONIAL in interiors
- Especially recommended for DQS from L'ANTIC COLONIAL.
- Especially recommended for LINKFLOOR from L'ANTIC COLONIAL.
- Especially recommended for KRION.

Coverage:

- 20 x 30 cm tile 3 kg / m²
- 30 x 30 cm tile 3 kg / m²
- 30 x 60 cm tile 4 kg / m²
- 44 x 44 cm tile 4 kg / m²

Materials:

- Large format ceramics.
- Porcelain tiles with a water absorption < 0.5% as per EN-ISO 10545-3.
- Glass mosaic.
- Natural stone and marble not prone to staining.
- DQS slabs and other kinds of marble agglomerate.
- Krion slabs and other kinds of Solid Surface.

Certifications/Standards:

EN 12004 R2 T

Substrates:

- Concrete or mortar substrates.
- Plasterboards and plaster or anhydrite walls.
- Plasterboards/wood boards.
- Existing wall tiles*.
- Metal sheets.
- Polyester or PVC surfaces.

politech n

KEA	SAP	P/EU
B41061005	100138260	politech n blanco 7,62 p/kg

Packaging

Presentation	Europallet
12 kg can	576 kg/pallet



* **super-prim** improves the adherence on polished ceramics and glossy finishing tiles

Before using this product in any application not indicated in this catalogue, please perform a test or refer to the product's technical sheet.

unilax

unilax is a latex that, mixed with cement-based adhesives like **one-flex n**, **fr-one n** or **super one n**, **rapimax n** or **maxifluid** improves bonding strength and flexibility up to level C2 S2 as per EN 12004. Specially recommended for laying wall tiles outdoors.

A resin-based latex that can be added to cement-based adhesives to enhance their bonding strength and flexibility. Specially recommended for exterior facades.

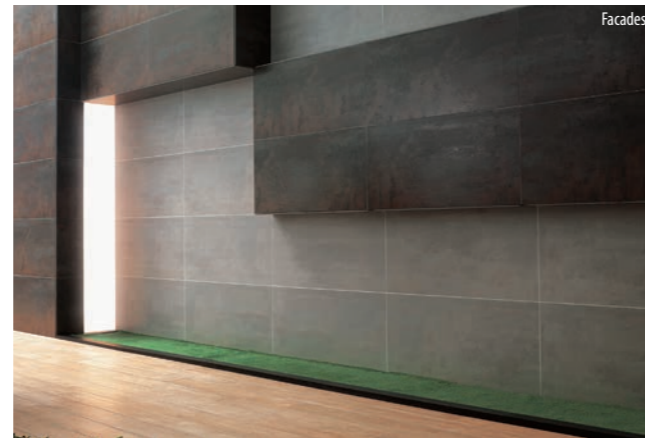

unilax

Features:

- Water-based acrylic resins latex.
- Resistant to the most common chemicals.
- Excellent resistance to UV rays and the effect of heat.
- Frost-resistant.

Recommended uses:

- Laying of tiles in facades.
- Large format ceramic floor tiles on radiant heating.
- Indoor large format ceramic tile coverings on slightly deformable substrates.
- Indoor and outdoor porcelain tile coverings.
- High traffic floor tiles.
- Pools and damp environments.

Coverage:

Product	%	litres	Kg/bag
one flex n blanco	34%	8.25-8.75	25
one flex n gris	32%	7.75-8.25	25
fr-one n	30%	7.25-7.75	25
super-one n	25%	6.00-6.50	25
rapimax n	21%	5.00-5.50	25
maxifluid	21%	5.00-5.50	25

Materials:

- Large format ceramics.
- Porcelain tiles with a water absorption < 0.5% as per EN-ISO 10545-3.
- Glass mosaic.
- Natural stone and marble not prone to staining.
- DQS slabs and other kinds of marble agglomerate.

Substrates:

- Concrete or mortar substrates.
- Plasterboards.
- Plywood panels.
- Existing wall tiles*.

Packaging

Presentation	Europallet
20 kg can	560 kg/pallet
5 kg can	480 kg/pallet



unilax

KEA	SAP	P/EU
B51601002	100004376	unilax 3,71 p/kg
B51602002	100004377	unilax 4,24 p/kg

* **super-prim** improves the adherence on polished ceramics and glossy finishing tiles

Before using this product in any application not indicated in this catalogue, please perform a test or refer to the product's technical sheet.

fonolax

fonolax is a latex that, mixed with cement-based adhesives **one-flex n**, **fr-one n**, **super one n**, **rapimax n** or **maxifluid**, improves bonding strength and flexibility up to level C2 S2 as per EN 12004. Specially recommended for laying ceramic tiles directly on soundproofing sheets.

An additive of synthetic resins that replaces the water in the mix and adds increased flexibility. Specially recommended as additive for the **super-one** adhesive in the installation of the **fonopac r** soundproofing.

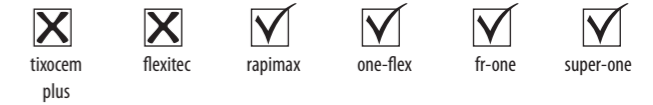

fonolax

Features:

- Water-based acrylic resins latex.
- Excellent resistance to UV rays and the effect of heat.
- Frost-resistant.

Recommended uses:

- Floor tiles on soundproofing against impact noise.
- Large format ceramic floor tiles on radiant heating.
- Indoor large format ceramic tile coverings on deformable substrates.
- Indoor and outdoor porcelain tile coverings.
- High traffic floor tiles.
- Pools and damp environments.

Coverage:

Product	%	litres	Kg/bag
one flex n blanco	34%	8.25-8.75	25
one flex n gris	32%	7.75-8.25	25
fr-one n	30%	7.25-7.75	25
super-one n	25%	6.00-6.50	25
rapimax n	21%	5.00-5.50	25
maxifluid	21%	5.00-5.50	25

Materials:

- Large format ceramics.
- Porcelain tiles with a water absorption < 0.5% as per EN-ISO 10545-3.
- Glass mosaic.
- Natural stone and marble not prone to staining.

Substrates:

- Soundproofing sheets:
 - **fonopac r**
 - **fonopac r Eco**
- Cement covered floors and walls .

Packaging

Presentation	Europallet
5 kg can	480 kg/pallet



fonolax

KEA	SAP	P/EU
B52502001	100004385	fonolax 2,22 p/kg

Before using this product in any application not indicated in this catalogue, please perform a test or refer to the product's technical sheet.

concealed facade fixings

Innovative concealed fixing clip for ceramic tiles in **bonded facades**. The fixings fit within small slots done on the porcelain piece and are anchored to the support by a stainless steel screw. Once the joints are grouted, the fixings are not visible anymore, not affecting the facade design.

These fixings have been designed as a security element in porcelain tile walls installed by the thin layer, double bonding method. We recommend the use of type C2 S2 cement-based adhesives as per EN 12004.

As a general rule, we recommend this kind of fixing from a height corresponding to first concrete slab. In any case, standards in force must be observed for every project.

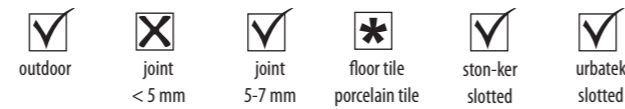

concealed facade fixings

Features:

- 1.4301 (AISI 304 V2A) stainless steel clips.
- Suitable for 5 - 7 mm wide joints.
- Suitable for tiles 9 to 12 mm thick.
- Start fixings available in 80 and 160 mm lengths for overhanging installations.
- Includes stainless steel screw and plug.

Coverage:

Coverage changes with every facade design. In the case of a regular facade with no gaps, clip calculation would be the following:

Tile cm	Type I fixings	Type A/T fixings
	u/m ²	u/m ²
43.5 x 65.9	5.6	1.4
44 x 66	5.5	1.4
60 x 60	4.5	1.1
45 x 90	4.0	1.0
60 x 120	3.4	0.8

Additional materials:

fr-one gris n	6,00 – 7,00 kg/m ²
unilax	1,80 – 2,45 l/m ²
unicem	1.25 – 1.75 kg/m ²

concealed facade fixings

KEA	SAP	concealed fixing	P/EU
B80111001	100005743	minimum I joint	1,42 p/u

KEA	SAP	concealed fixing	P/EU
B80111002	100005744	minimum A/T joint 4 cm	1,42 p/u
B80111003	100005745	minimum A/T joint 8cm	1,59 p/u
B80400012	100032736	minimum A/T joint 16cm	5,10 p/u

Screws and plugs included

Recommended uses:

- Laying of tiles in facades.
- Laying of ceramics in ceilings and cornices.
- Indoor laying of large format porcelain tiles at a certain height.

Materials:

- Medium and large format porcelain tiles resistant to side slotting:
 - STON-KER
 - PAR-KER
 - URBATEK

Substrates:

- Cement covered floors and walls .
- In outdoor cement screeds, we recommend to add **unicem**:
150 gr **unicem** / m² and milimeter of screed thickness

Packaging

Presentation
50 u. bag

Presentation
50 u. bag
50 u. bag
50 u. bag

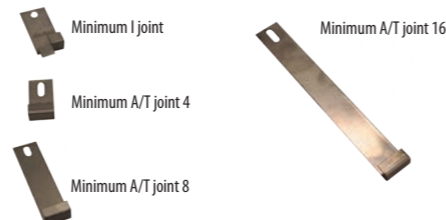

visible facade fixings

Visible fixing clip for ceramic tiles in **bonded facades**. Fixings hold the ceramic tiles and are anchored to the support by a stainless steel screw. Once the joints are grouted, the fixings are visible, and a 5 mm clip can be seen.

These fixings have been designed as a security element in porcelain tile walls installed by the thin layer, double bonding method. We recommend the use of type C2 S2 cement-based adhesives as per EN 12004.

As a general rule, we recommend this kind of fixing from a height corresponding to first concrete slab. In any case, standards in force must be observed for every project.

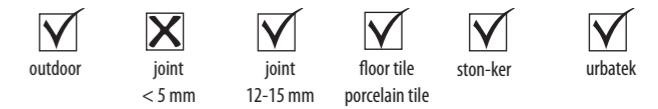
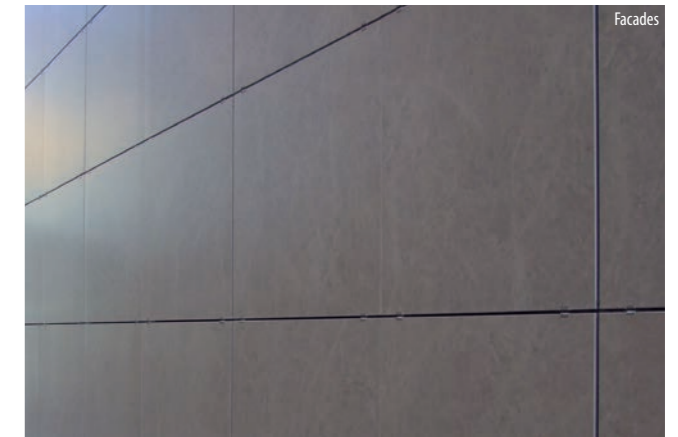

visible facade fixings

Features:

- 1.4301 (AISI 304 V2A) stainless steel clips.
- Suitable for 12 mm wide joints.
- Suitable for tiles 10 to 12 mm thick.
- Available in metallic or lacquered finish.
- Customizable color lacquering on demand.
- Includes stainless steel screw and plug.

Coverage:

Coverage changes with every facade design. In the case of a 5 x 20 m regular facade with no gaps, clip calculation would be the following:

Tile cm	100 fixing	1100 fixing	1200 fixing	1500 fixing
	u/m ²	u/m ²	u/m ²	u/m ²
43.5 x 65.9	0.04	0.58	0.22	3.19
44 x 66	0.04	0.58	0.22	3.19
60 x 60	0.04	0.64	0.16	2.56
45 x 90	0.04	0.42	0.20	2.10
60 x 120	0.38	0.32	1.52	1.28

Additional materials:

fr-one gris n	6,00 – 7,00 kg/m ²
unilax	1,80 – 2,10 l/m ²
unicem	1,80 – 2,15 kg/m ²

visible facade fixings

KEA	SAP	fixing clip stainless	P/EU
B80107010	100005737	ref. 1000	1,42 p/u
B80107011	100005738	ref. 1100	2,54 p/u
B80107012	100005739	ref. 1200	1,42 p/u
B80107013	100005740	ref. 1500	1,91 p/u

KEA	SAP	fixing clip lac. black	P/EU
B80400008	100008056	ref. 1000	1,53 p/u
B80400005	100008057	ref. 1100	2,65 p/u
B80400007	100008058	ref. 1200	1,53 p/u
B80400006	100008059	ref. 1500	2,02 p/u

Screws and plugs included

Recommended uses:

- Laying of tiles in facades.
- Laying of ceramics in ceilings and cornices.
- Indoor laying of large format porcelain tiles at a certain height.

Materials:

- Medium and large format porcelain tiles:
 - STON-KER
 - PAR-KER
 - URBATEK

Substrates:

- Cement covered floors and walls .
- Concrete slabs.
- In outdoor cement screeds, we recommend to add **unicem**:
150 gr **unicem** / m² and milimeter of screed thickness.

Packaging

Presentation
50 u. bag
50 u. bag
50 u. bag
50 u. bag

Presentation
50 u. bag
50 u. bag
50 u. bag
50 u. bag





Grouting material and elastic sealants

Cement-based materials for tile joints

colorstuk 0-4	97
colorstuk 2-12	99
colorstuk especial n	101
colorstuk rapid n	103

Epoxy grouting materials

epotech aqua	105
epotech nature	106
epotech crystal	107
epotech gold & silver	108
epotech	109

Leveling system for ceramic tiles

self-leveling spacers	111
-----------------------	-----

Elastic joint sealants

s-107	113
s-107 n	114
p-404	115

Additive for grouting material

cl-stuk	116
---------	-----

colorstuk 0-4

colorstuk 0-4 is a type CG 2 fine grain grouting material as per EN 13888, for grouting joints up to 4 mm. It is easy to apply, resistant and color stable, and it is specially recommended for rectified tiles.

A high-tech, fine grained colored mortar for grouting tile joints from 0 to 4 mm. Suitable for all kinds of ceramic tiles and natural stone. Indoors and outdoors.



colorstuk 0-4

Features:

- Cement-based, single-component, colored mortar.
- Fine texture mortar for grouting tile joints up to 4 mm.
- Easy to apply and clean.
- Resistant to heat and UV radiation.
- Frost-resistant.
- Wide color range.
- Mixing water:
 - colorstuk 0-4 n white 1,7 l per 5 kg bag.
 - colorstuk 0-4 n white 8,5 l per 25 kg bag.
 - colorstuk 0-4 n white 1,3 l per 5 kg bag.

Recommended uses:

- Tile joints up to 4 mm.
 - Indoor wall tile coverings. Specially recommended for rectified tiles.
 - Indoor floor tiles, including public buildings.
- In the following applications, replace mixing water by **cl-stuk** additive.
- Outdoor floors.
 - High traffic floor tiles.
 - Floor tiles on radiant heating.
 - Pools and damp environments.

Materials:

- Absorbent and non-absorbent ceramic tiles, including porcelain tiles.
 - Glass mosaic.
 - Natural stone and marble not prone to staining.
- In the following applications, replace mixing water by **cl-stuk** additive.
- Wall tiles with mosaic-like patterns.
 - DQS slabs and other kinds of marble agglomerate.

Substrates:

- All usual substrates for ceramic tiles laying.

Certifications/Standards:

EN 13888 CG2

Coverage for 1 mm joint.

Tile	a x b mm	h mm	gr/m ²
Mosaic	20 x 20	4	600
Mosaic	50 x 50	4	240
Tile	100 x 100	6	192
Tile	200 x 200	8	120
Tile	200 x 316	10	122
Tile	316 x 446	10	81
Tile	316 x 596	10	73
Tile	316 x 900	10	64
Tile	316 x 316	10	95
Tile	446 x 446	10	67
Tile	446 x 660	10	57
Tile	596 x 596	10	50
Tile	800 x 800	10	38
Tile	596 x 1200	10	38
Tile	180 x 659	10	106
Tile	193 x 1200	10	90

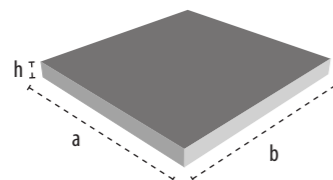

* Replace mixing water by **cl-stuk**.

Before using this product in any application not indicated in this catalogue, please perform a test or refer to the product's technical sheet.

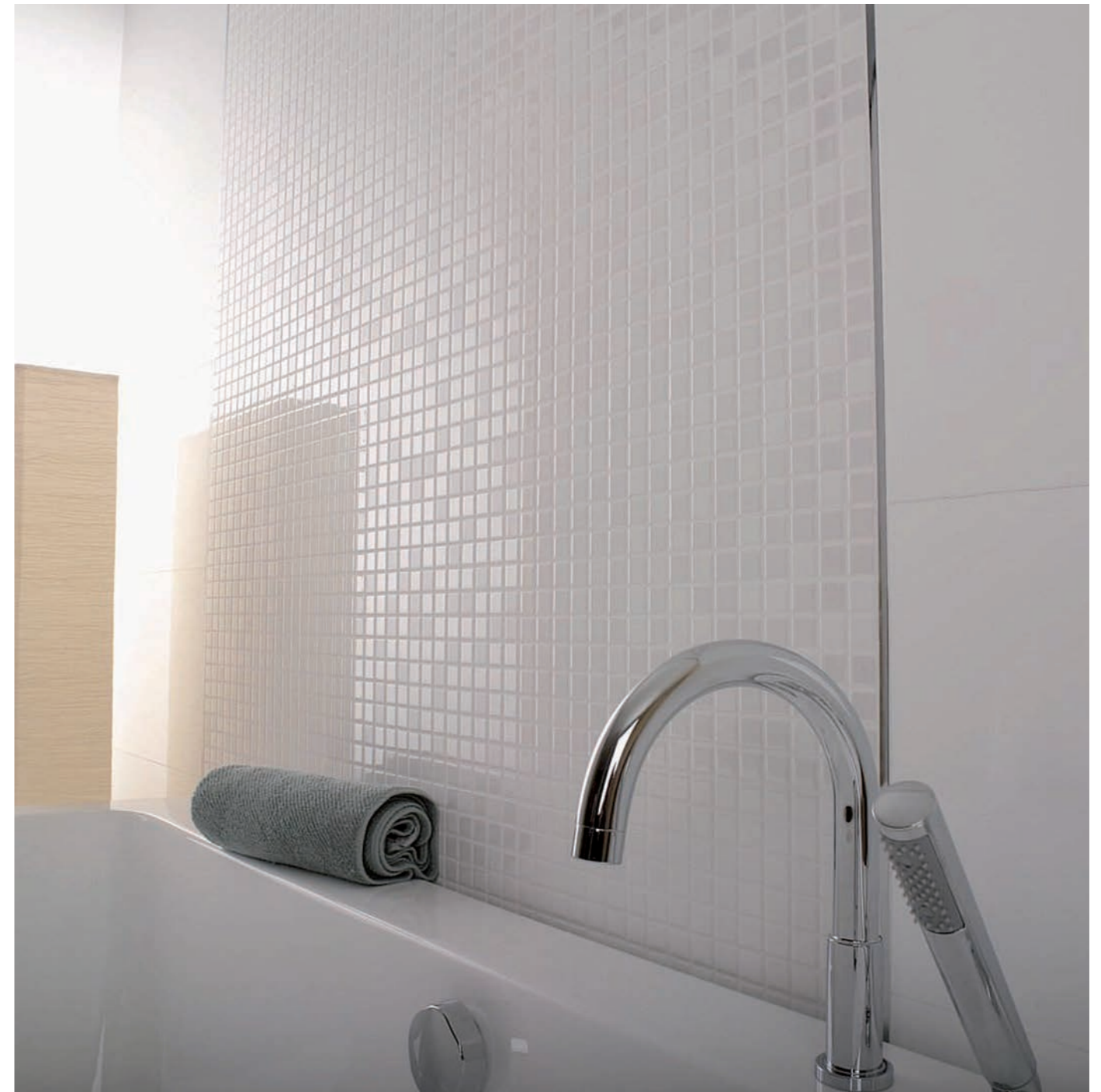

colorstuk 0-4

KEA	SAP		P/EU
B21501001	100004253	blanco	1,32 p/kg
B21502002	100004255	manhattan	1,61 p/kg
B21502003	100004256	bahama	1,61 p/kg
B21502004	100004257	cemento	1,61 p/kg
B21502005	100004258	antracita	1,61 p/kg
B21502006	100004259	negro	1,61 p/kg
B21502009	100004260	marfil	1,61 p/kg
B21502010	100004261	marrón	1,61 p/kg
B21502016	100004262	beige	1,66 p/kg
B21522218	100060532	caramelo	1,53 p/kg
B21522217	100060533	moka	1,53 p/kg
B21522219	100060534	gris	1,57 p/kg

Packaging

Presentation	Europallet
5 kg bag	400 kg
5 kg bag	400 kg
5 kg bag	400 kg
5 kg bag	400 kg
5 kg bag	400 kg
5 kg bag	400 kg
5 kg bag	400 kg
5 kg bag	400 kg
5 kg bag	400 kg
5 kg bag	400 kg
5 kg bag	400 kg
5 kg bag	400 kg
5 kg bag	400 kg
5 kg bag	400 kg

Colors shown are approximate. There are physical samples available to customers for checking the real grout color.

Before using this product in any application not indicated in this catalogue, please perform a test or refer to the product's technical sheet.

colorstuk 2-12

colorstuk 2-12 is a type CG 2 fine grain grouting material as per EN 13888, for grouting joints from 2 to 12 mm. It is easy to apply, resistant and color stable, and it is specially recommended for floors with a wide joint.

A high-tech, fine grained colored mortar for grouting tile joints from 2 to 12 mm. Suitable for all kinds of ceramic tiles and natural stone. Indoors and outdoors.



- 
 rustic floors
- 
 rectified ceramics
- 
 indoors
- 
 high traffic
- 
 outdoor floors
- 
 radiant heating

colorstuk 2-12

Features:

- Cement-based, single-component, colored mortar.
- Fine texture mortar for grouting tile joints from 2 to 12 mm.
- Easy to apply and clean.
- Resistant to heat and UV radiation.
- Frost-resistant.
- Wide color range.
- Mixing water: colorstuk 2-12 n color 1,0 l per 5 kg bag.
colorstuk 2-12 n color 5,0 l per 25 kg bag.

Recommended uses:

- Tile joints from 2 to 12 mm.
 - Indoor wall tile coverings with wide joint.
 - Indoor floors. Specially recommended for rustic tiles.
- In the following applications, replace mixing water with **cl-stuk** additive.
- Outdoor floor and wall tiles.
 - High traffic floor tiles.
 - Floor tiles on radiant heating.
 - Pools and damp environments.

Materials:

- Absorbent and non-absorbent ceramic tiles, including porcelain tiles.
 - Glass mosaic.
 - Natural stone and marble not prone to staining.
 - Terracotta tiles.
- In the following applications, replace mixing water with **cl-stuk** additive.
- Ceramic tiles with relief to be covered with grouting material.

Substrates:

- All usual substrates for ceramic tiles laying.

Certifications/Standards:

EN 13888 CG2

Coverage for 1 mm joint.

Tile	a x b mm	h mm	gr/m ²
Mosaic	20 x 20	4	600
Mosaic	50 x 50	4	256
Tile	100 x 100	6	192
Tile	200 x 200	8	128
Tile	200 x 316	10	131
Tile	316 x 446	10	87
Tile	316 x 596	10	77
Tile	316 x 900	10	68
Tile	316 x 316	10	101
Tile	446 x 446	10	72
Tile	446 x 660	10	61
Tile	596 x 596	10	54
Tile	800 x 800	10	40
Tile	596 x 1200	10	40
Tile	180 x 659	10	113
Tile	193 x 1200	10	96

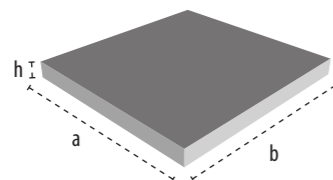

* Replace mixing water by **cl-stuk**.



colorstuk 2-12

KEA	SAP	Color	P/EU
B21522002	100004273	manhattan	1,68 p/kg
B21522004	100004275	cemento	1,68 p/kg
B21522005	100004276	antracita	1,68 p/kg
B21522006	100004277	negro	1,68 p/kg
B21522009	100004278	marfil	1,68 p/kg
B21522016	100004279	beige	1,68 p/kg
B21521001	100004271	blanco	1,35 p/kg
B21522224	100060541	gris	1,57 p/kg
B21522222	100060548	marrón	1,51 p/kg

Packaging

Presentation	Europallet
5 kg bag	400 kg
5 kg bag	400 kg
5 kg bag	400 kg
5 kg bag	400 kg
5 kg bag	400 kg
5 kg bag	400 kg
5 kg bag	400 kg
5 kg bag	400 kg
5 kg bag	400 kg
5 kg bag	400 kg

Colors shown are approximate. There are physical samples available to customers for checking the real grout color.







Before using this product in any application not indicated in this catalogue, please perform a test or refer to the product's technical sheet.

colorstuk especial n

colorstuk especial n is a type CG 2 very fine grain grouting material as per EN 13888, for grouting joints up to 4 mm. Its formula includes ultrafine aggregates, which make it specially recommended for tiles with a glaze sensitive to scratching.

A high-tech, fine grained colored mortar for grouting tile joints up to 4 mm. Specially recommended for grouting rectified ceramic tiles sensible to scratching.



- 
 glass mosaic
- 
 rectified ceramics
- 
 bath environments
- 
 Crystal series
- 
 high traffic
- 
 radiant heating

colorstuk especial n

Features:

- Cement-based, single-component, colored mortar.
- Ultrafine aggregates formula.
- Fine texture mortar for grouting tile joints up to 4 mm.
- Easy to apply and clean.
- Resistant to heat and UV radiation.
- Frost-resistant.
- Wide special colors range.
- Mixing water: colorstuk especial n color 0,65 l per 2 kg bag.

Recommended uses:

- Tile joints up to 4 mm.
- Ceramic tiles with low hardness glaze as per Mohs scale.
- Indoor wall tile coverings. Specially recommended for rectified tiles.
- Indoor floor tiles, including public buildings.

In the following applications, replace mixing water with **cl-stuk** additive.

- Wall and floor tiles into direct contact with water.
- Floor tiles on radiant heating.

Materials:

- Absorbent and non-absorbent ceramic tiles.
- Ceramic tiles with special finishes.
- Glass mosaic.
- Natural stone and marble not prone to staining.
- Do not use on polished materials.

In the following applications, replace mixing water by **cl-stuk** additive.

- Wall tiles with mosaic-like patterns.
- DQS slabs and other kinds of marble agglomerate.

Substrates:

- All usual substrates for ceramic tiles laying.

Certifications/Standards:

EN 13888 CG2

Coverage for 1 mm joint.

Tile	a x b mm	h mm	gr/m ²
Mosaic	20 x 20	4	640
Mosaic	50 x 50	4	256
Tile	100 x 100	6	192
Tile	200 x 200	8	128
Tile	200 x 316	10	131
Tile	316 x 446	10	87
Tile	316 x 596	10	77
Tile	316 x 900	10	68
Tile	316 x 316	10	101
Tile	446 x 446	10	72
Tile	446 x 660	10	61
Tile	596 x 596	10	54
Tile	800 x 800	10	40
Tile	596 x 1200	10	40
Tile	180 x 659	10	113
Tile	193 x 1200	10	96

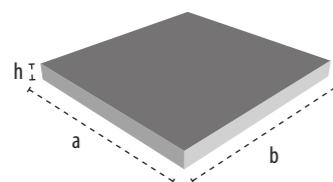

* Replace mixing water by **cl-stuk**.

Before using this product in any application not indicated in this catalogue, please perform a test or refer to the product's technical sheet.

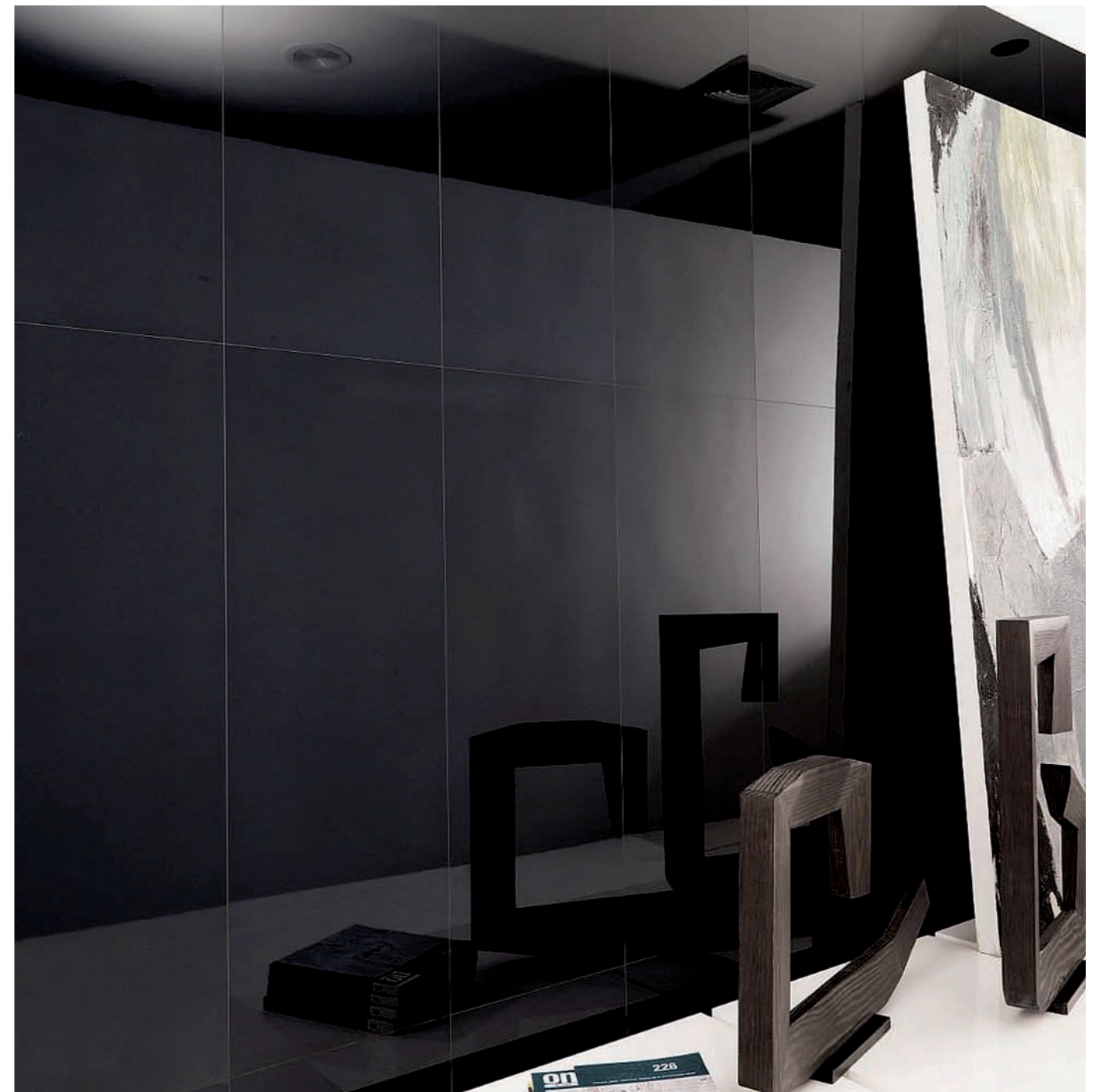

colorstuk especial n

KEA	SAP		P/EU
B24302045	100090682	acid	5,32 p/kg
B24302049	100090684	cherry	22,44 p/kg
B24302043	100090685	dark	7,80 p/kg
B24302047	100090686	moka	5,32 p/kg
B24302042	100090687	nacare	5,51 p/kg
B24302044	100090689	vanilla	5,32 p/kg
B24302046	100090690	white	5,32 p/kg
B24302051	100097181	graphite	7,75 p/kg

Packaging

Presentation	Europallet
2 kg bag	432 kg
2 kg bag	432 kg
2 kg bag	432 kg
2 kg bag	432 kg
2 kg bag	432 kg
2 kg bag	432 kg
2 kg bag	432 kg
2 kg bag	432 kg
2 kg bag	432 kg

Colors shown are approximate. There are physical samples available to customers for checking the real grout color.

Before using this product in any application not indicated in this catalogue, please perform a test or refer to the product's technical sheet.

colorstuk rapid n

colorstuk rapid n is a type CG 2 high-performance, cement-based grouting material as per EN 13888, for grouting joints up to 15 mm. Suitable for all kinds of ceramic tiles and natural stone, it is specially recommended for outdoor applications and permanently damp environments.

A high-tech, fine grained colored mortar with fast setting and hardening times for grouting tile joints up to 15 mm. Suitable for all kinds of ceramic tiles and natural stone. Indoors and outdoors.



- ✓
glass
mosaic
- ✓
rectified
ceramics
- ✓
high traffic
- ✓
bathroom
environments
- ✓
pools
- ✓
facades

colorstuk rapid n

Features:

- Cement-based, single-component, colored mortar.
- Fine texture mortar for grouting tile joints up to 15 mm.
- Mortar with fast setting and hardening times.
- It prevents efflorescences.
- Excellent mechanical resistance.
- Resistant to heat and UV radiation.
- Frost-resistant.
- Waterproof mortar.
- Anti-mold action.
- Easy to apply and clean.
- Wide color range.
- Mixing water: colorstuk rapid n 1,1 l per 5 kg bag.

Recommended uses:

- Tile joints up to 15 mm.
- Indoor wall and floor tiles.
- Outdoor floors and terraces.
- High traffic floor tiles.
- Floor tiles on radiant heating.
- Pools and damp environments.
- Outdoor wall tiles in facades.

Materials:

- Absorbent and non-absorbent ceramic tiles, including porcelain tiles.
- Tiles with mosaic-like patterns.
- Glass mosaic.
- Clay and terracotta tiles.
- Natural stone and marble not prone to staining.

Substrates:

- All usual substrates for ceramic tiles laying.

Certifications/Standards:

EN 13888 CG2 Ar W

Coverage for 1 mm joint.

Tile	a x b mm	h mm	gr/m ²
Mosaic	20 x 20	4	600
Mosaic	50 x 50	4	240
Tile	200 x 200	8	192
Tile	200 x 200	8	120
Tile	200 x 316	10	122
Tile	316 x 446	10	81
Tile	316 x 596	10	73
Tile	316 x 900	10	64
Tile	316 x 316	10	95
Tile	446 x 446	10	67
Tile	446 x 660	10	57
Tile	596 x 596	10	50
Tile	800 x 800	10	38
Tile	596 x 1200	10	38
Tile	180 x 659	10	106
Tile	193 x 1200	10	90

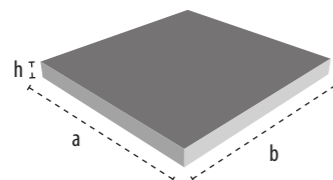

colorstuk rapid n

KEA	SAP		P/EU
B22501001	100004294	blanco	2,65 p/kg
B22502002	100004295	manhattan	2,21 p/kg
B22502003	100004296	bahama	2,93 p/kg
B22502004	100004297	cemento	2,21 p/kg
B22502005	100004298	antracita	2,21 p/kg
B22502006	100004299	negro	2,79 p/kg
B22502007	100004300	caramelo	2,79 p/kg
B22502008	100004301	terracota	2,79 p/kg
B22502009	100004302	marfil	2,90 p/kg
B22502010	100004303	marrón	2,79 p/kg
B22502011	100004304	tabaco	4,06 p/kg
B22502013	100004305	gris	2,71 p/kg
B22502016	100004308	beige	2,90 p/kg
B21522220	100060549	moka	2,57 p/kg
B22902006	100004309	negro	2,39 p/kg

Colors shown are approximate. There are physical samples available to customers for checking the real grout color.

Packaging

Presentation	Europallet
5 kg bag	400 kg
5 kg bag	400 kg
5 kg bag	400 kg
5 kg bag	400 kg
5 kg bag	400 kg
5 kg bag	400 kg
5 kg bag	400 kg
5 kg bag	400 kg
5 kg bag	400 kg
5 kg bag	400 kg
5 kg bag	400 kg
5 kg bag	400 kg
5 kg bag	400 kg
5 kg bag	400 kg
5 kg bag	400 kg
25 kg bag	1.000 kg

epotech aqua

epotech aqua is a new line of epoxy putties for grouting tile joints. Two-component epoxy putty with no organic solvents. It is waterproof, it has outstanding chemical and mechanical properties and it is easy to apply. Specially recommended for application on mosaics and ceramic tiles with relief.

This material is suitable for grouting joints from 0 to 10 mm in floor and wall tiles, indoors and out. Excellent resistance to chemicals. Suitable for pools and permanently damp environments. Suitable as high adherence grouting material for ceramic tiles with any absorption level and format, for glass mosaic or natural stone.



- kitchen countertops
- bathroom environments
- public toilets
- adhesive epoxy
- shower trays showers
- pools

epotech aqua

Features:

- Two-component colored epoxy putty.
- Easy to apply and clean. This product is free of organic solvents and plasticizers
- Excellent joint color stability.
- Resistance to most chemicals and alkali, even in high concentrations.
- Waterproof joint, no water absorption.
- Excellent adherence and mechanical resistance.
- Tile joints up to 10 mm.
- Wide color range.

Recommended uses:

- Public toilets and private bathrooms.
- Wall tiles with special chemical resistance.
- Pools and damp environments.
- Tile joints with uniform color and shade, resistant to the passing of time.
- High traffic and outdoor floors.
- High adherence grouting material. Specially recommended.
 - Slate and natural stone.
 - Mesh backed glass mosaic.
- Especially recommended for meshed glass mosaics from L'ANTIC COLONIAL in wet areas.

Materials:

- Absorbent and non-absorbent ceramic tiles, including porcelain tiles.
- Tiles with mosaic-like patterns. Please refer to PORCELANOSA / VENIS catalogues.
- Glass mosaic.
- Natural stone and marble not prone to staining.

Substrates:

- All usual substrates for ceramic tiles laying.

Packaging

Presentation	Europallet
3.6 kg can	316.8 Kg
3.6 kg can	316.8 Kg
3.6 kg can	316.8 Kg
3.6 kg can	316.8 Kg
3.6 kg can	316.8 Kg



Coverage for 1 mm joint.

Tile	a x b mm	gr/m ²
Mosaic	20 x 20	960
Wall tile	mosaic type 20 x 30	600-800
Wall tile	20 x 30	125
Wall tile	30 x 90	90
Floor tile	30 x 30	95
Floor tile	44 x 44	75
Floor tile	60 x 60	60

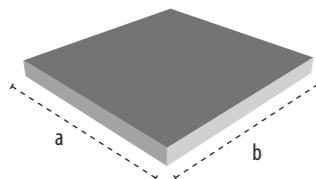

epotech aqua

KEA	SAP		P/EU
B42562016	100090692	antracita	13,80 p/kg
B42562017	100090693	beige	13,80 p/kg
B42562020	100090694	blanco	14,01 p/kg
B42562019	100090696	gris	13,80 p/kg
B41061004	100116037	marfil	13,80 p/kg
B35200002	100113684	epoxy cleaning kit	63,55 p/u

Colors shown are approximate. There are physical samples available to customers for checking the real grout color.

Before using this product in any application not indicated in this catalogue, please perform a test or refer to the product's technical sheet.

epotech nature

epotech nature is a new micro grain porcelain grout for the sealing of joints in ceramic tiles with designs inspired by nature. It has been specially developed for porcelain tiles that reproduce the appearance and texture of wood, such as PORCELANOSA Group's par-ker. Professional use.

This material is suitable for grouting tile joints up to 5 mm. in floorings and wall coverings, both indoors and outdoors. Excellent resistance to chemicals. Suitable for pools and permanently damp environments. Suitable as high adherence grouting material for ceramic tiles with any absorption level and format, for glass mosaic, or natural stone.



- ceramic parket
- par-ker
- high traffic
- outdoor
- shower trays
- pools

epotech nature

Characteristics:

- Two-component colored epoxy putty.
- Easy to apply and clean. This product is free of organic solvents and plasticizers.
- Excellent joint color stability.
- Resistance to most chemicals and alkali, even in high concentrations.
- Waterproof joint, no water absorption.
- Excellent adherence and mechanical resistance. Hypoallergenic and bacteriostatic.
- Tile joints up to 5 mm.
- Wide range of colors inspired by natural woods.

Recommended use:

- Floorings and wall coverings in natural wood-inspired ceramics.
- Tile joints with uniform color and shade, resistant to the passing of time.
- Floorings with built-in heating.
- Pools and damp environments.
- High traffic floor tiles
- Outdoor floorings protected against the presence of rising moisture
- Floorings and wall coverings in direct contact with chemicals. See technical sheet.

Consumo para junta de 1 mm:

Tile	a x b mm	h	gr/ m ²
Wall covering	316 x 900	11	71
Wall covering	330 x 1000	11	67
STON-KER	446 x 446	11	75
STON-KER	435 x 659	11	63
STON-KER	446 x 660	11	62
STON-KER	450 x 900	11	55
STON-KER	596 x 596	11	56
STON-KER	800 x 800	11	42
STON-KER	596 x 1200	11	293
PAR-KER	180 x 659	11	118
PAR-KER	219 x 660	11	101
PAR-KER	143 x 900	11	135
PAR-KER	220 x 900	11	94
PAR-KER	193 x 1200	11	100
PAR-KER	193 x 1800	12	104
PAR-KER	294 x 1800	12	171

epotech nature

KEA	SAP		P/EU
B42562034	100177485	wenge	17,77 p/kg
B42562029	100177512	doussie	17,77 p/kg
B42562033	100177505	iroko	17,77 p/kg
B42562035	100177484	oak	17,77 p/kg
B42562028	100177513	elm	17,77 p/kg
B42562031	100177494	beech	17,77 p/kg
B42562032	100177504	ash	17,77 p/kg
B42562030	100177514	maple	17,77 p/kg

Colors shown are approximate. There are physical samples available to customers for checking the real grout color.

Materials:

- Absorbent and non-absorbent ceramic tiles, including porcelain tiles, such as the following from PORCELANOSA Group:
 - PAR-KER
 - STON-KER
 - URBATEK
 - XLIGHT
- Glass mosaic.
- Natural stone and marble not prone to staining.

Substrates:

- All usual substrates for laying ceramic tiles.

Packaging

Presentation	Europallet
1.5 kg container	378 Kg
1.5 kg container	378 Kg
1.5 kg container	378 Kg
1.5 kg container	378 Kg
1.5 kg container	378 Kg
1.5 kg container	378 Kg
1.5 kg container	378 Kg
1.5 kg container	378 Kg



epotech crystal

epotech crystal is an epoxy putty for grouting tile joints. Two-component putty with a translucent finish. It reflects the color of the tile or mosaic surrounding the joint. It features all the properties of epoxy putties: watertightness, high resistance to chemicals and mechanical properties. Specially recommended for application on mosaics and ceramic tiles with relief. Extra fine, micro grain porcelain grout.

This material is suitable for grouting joints up to 5 mm in floor and wall tiles indoors. Excellent resistance to chemicals in high concentrations. Suitable for permanently damp environments.

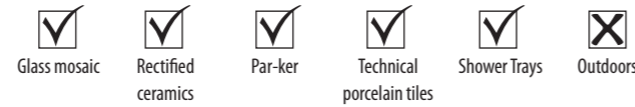

epotech crystal

Features:

- Extra fine, micro grain porcelain grout.
- Easy to apply and clean epoxy putty.
- Translucent appearance.
- High resistance to most acids and alkali, even in high concentrations.
- Waterproof joint, no water absorption.
- Excellent adherence and mechanical resistance.
- Prevents the development of fungi and bacteria.
- Tile joints up to 5 mm.

Recommended uses:

- Wall and floor tiles with minimum joint.
- Indoor floor and wall tiles.
- Mosaic or natural stone wall coverings.
- Wall tiles and mosaics with glass elements.
- Par-ker floor coverings.
- Technical, porcelain floor coverings.

Coverage for 1 mm joint.

Tile	a x b mm	gr/m ²
Mosaic	20 x 20	960
Wall tile	mosaic type	600-800
Wall tile	20 x 30	125
Wall tile	30 x 90	90
Floor tile	30 x 30	95
Floor tile	44 x 44	75
Floor tile	60 x 60	60

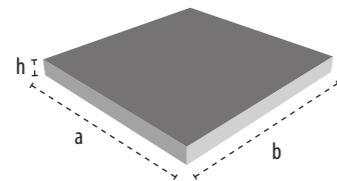

Materials:

- Absorbent and non-absorbent ceramic tiles, including porcelain tiles.
- Glass mosaic.
- Wall tiles and mosaics with glass elements.
- Natural stone and marble not prone to staining.

Before applying **epotech crystal** on any ceramic floor not included in the list above, carry out a prior test or check with the Technical Department at butech.

Substrates:

- All usual substrates for ceramic tiles laying.

Certifications/Standards:

EN 13888 RG

Packaging

Presentation	Europallet
3 kg can	295 Kg



epotech crystal

KEA	SAP	P/EU
B42562025	100126899	crystal
		16,52 p/kg

Before using this product in any application not indicated in this catalogue, please perform a test or refer to the product's technical sheet.

epotech gold & silver

epotech gold & silver is an epoxy putty for grouting tile joints. Two-component putty plus metal flakes featuring a unique, glossy finish. It features all the properties of epoxy putties: watertightness, high resistance to chemicals and mechanical properties. Specially recommended for application on mosaics and ceramic tiles with relief.

This material is suitable for grouting joints up to 5 mm in floor and wall tiles indoors. Excellent resistance to chemicals in high concentrations. Suitable for permanently damp environments.



epotech gold & silver

Features:

- Two-component epoxy putty plus golden or silver metallic additive.
- Easy to apply and clean.
- High resistance to most chemicals and alkali, even in high concentrations.
- Waterproof joint, no water absorption.
- Excellent adherence and mechanical resistance.
- Prevents the development of fungi and bacteria.
- Tile joints up to 5 mm.

Recommended uses:

- Wall and floor tiles with decorative, metallic finish.
- Indoor wall and floor tiles.
- Damp environments.
- Tile joints with uniform color and shade, resistant to the passing of time.

Consumption for 1 mm joint.

Tile	a x b mm	gr/m ²
Mosaic	20 x 20	960
Wall tile	mosaic type	600-800
Wall tile	20 x 30	125
Wall tile	30 x 90	90
Floor tile	30 x 30	95
Floor tile	44 x 44	75
Floor tile	60 x 60	60

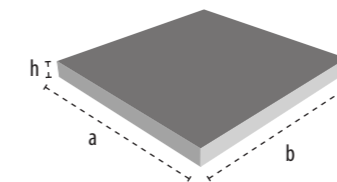

Materials:

- Absorbent and non-absorbent ceramic tiles, including porcelain tiles.
- Glass mosaic.
- Natural stone and marble not prone to staining.

Before applying **epotech gold & silver** on metallic profiles or wall tiles with special glazes, carry out a prior test or check with the Technical Department at butech.

Substrates:

- All usual substrates for ceramic tiles laying.

Certifications/Standards:

EN 13888 RG

Packaging

Presentation	Europallet
3 kg can	295 Kg

Packaging

Presentation	Europallet
3 kg can	295 Kg



epotech gold

KEA	SAP	P/EU
B42562021	100121692	gold
		26,48 p/kg

epotech silver

KEA	SAP	P/EU
B42562022	100121693	silver
		25,70 p/kg

Before using this product in any application not indicated in this catalogue, please perform a test or refer to the product's technical sheet.

epotech

epotech is an epoxy putty for grouting tile joints. Waterproof, two-component epoxy putty with outstanding chemical and mechanical properties. Specially recommended for tile joints requiring the highest mechanical and chemical properties.

This material is suitable for grouting joints from 3 to 15 mm in floor and wall tiles, indoors and out. Excellent resistance to chemicals in high concentrations. Suitable for pools and permanently damp environments. Suitable as high adherence grouting material for ceramic tiles with any absorption level and format, for glass mosaic or natural stone.



epotech

Features:

- Two-component colored epoxy putty.
- Excellent joint color stability.
- High resistance to most chemicals and alkali, even in high concentrations.
- Waterproof joint, no water absorption.
- Excellent adherence and mechanical resistance.
- Tile joints from 3 to 15 mm.

Recommended uses:

- Wall tiles with special chemical resistance.
- Chemical and food industry and premises subject to thorough cleaning.
- Pools and permanently damp environments, Turkish baths and spas.
- High traffic and outdoor floors.
- High adherence grouting material. Specially recommended.
 - Slate and natural stone.
 - Mesh backed glass mosaic.
- Especially recommended for slate from L'ANTIC COLONIAL.
- Especially recommended for AIRSLATE from L'ANTIC COLONIAL.

Materials:

- Absorbent and non-absorbent ceramic tiles, including porcelain tiles.
- Glass mosaic.
- Natural stone and marble not prone to staining.

Substrates:

- All usual substrates for ceramic tiles laying.

Certifications/Standards:

EN 13888 RG

Packaging

Presentation	Europallet
5 kg can	375 kg/pallet
5 kg can	375 kg/pallet
5 kg can	375 kg/pallet
5 kg can	375 kg/pallet



Coverage for 1 mm joint.

Tile	a x b mm	gr/m ²
Mosaic	20 x 20	960
Wall tile	mosaic type 20 x 30	600-800
Wall tile	20 x 30	125
Wall tile	30 x 90	90
Floor tile	30 x 30	95
Floor tile	44 x 44	75
Floor tile	60 x 60	60

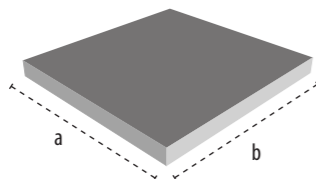

epotech

KEA	SAP		P/EU
B42562001	100004371	blanco	7,40 p/kg
B42562002	100004372	manhattan	6,74 p/kg
B42562005	100004373	antracita	6,74 p/kg
B42562009	100007815	marfil	6,55 p/kg
B35200002	100113684	epoxy cleaning kit	63,55 p/u

Colors shown are approximate. There are physical samples available to customers for checking the real grout color.

Before using this product in any application not indicated in this catalogue, please perform a test or refer to the product's technical sheet.

Grouting material selection chart

1. Once chosen the wall tile model, determine the type of ceramic material. Refer to the manufacturer's catalogue: PORCELANOSA, VENIS, URBATEK and L'ANTIC COLONIAL.

2. Search in the wall or floor tables, given the case, the grouts which are compatible with the type of ceramic material chosen.

WALL	colorstuk 0-4	colorstuk 2-12	colorstuk especial	colorstuk rapid n	epotech aqua	epotech crystal	epotech gold & silver	epotech
Wall tile								
Rectified wall tiles								
Gloss (Crystal) wall tiles								
Mosaic-like wall tiles			*					
Glass mosaic			*		**	**	**	**
Urbatek								
Urbatek polished					**	**	**	**
Ston-ker								
Par-ker								
XLIGHT								
Natural stone	**	**	**	**	**	**	**	**

FLOOR	colorstuk 0-4	colorstuk 2-12	colorstuk especial	colorstuk rapid n	epotech aqua	epotech crystal	epotech gold & silver	epotech
Stoneware tiles								
Porcelain tiles								
Urbatek								
Urbatek polished					**	**	**	**
Ston-ker								
Ston-ker brick / Mosaic								
Par-ker								
DQS	*				**	**	**	**
Natural stone	**	**	**	**	**	**	**	**
Glass mosaic			*		**	**	**	**

3. Check which one of the compatible adhesives best matches its final use and substrate type.

SUPPORT FINAL USE	Bath environment	Electric radiant floor heating	High traffic	Pool	Outdoor floor	Façade	Watertightness	Resistance to chemicals
colorstuk rapid n								
epotech aqua								
epotech crystal								
colorstuk 0-4	*	*	*					
colorstuk 2-12	*	*	*					
colorstuk especial	*	*						
epotech gold & silver								
epotech								

4. Once you have chosen an adhesive which is compatible with the tile and its final use, check its features in this catalogue.

Given the wide variety of natural stones and glass mosaics from L'ANTIC COLONIAL, we recommend to check the material's scratch and stain resistance.

*: Mix with **d-stuk** additive.

***: Be extremely cautious when cleaning the grout off the chosen floor or wall tile.

self-leveling spacers

Leveling system for ceramic tiles. Eases ceramic tile laying and guarantees a perfectly flat surface of the final installation. The system consists of a new type of spacer with adjustable height that levels the surrounding tiles and prevents them from moving. Specially recommended when tile, design or use features demand a perfect finish, with an even, seamless surface.

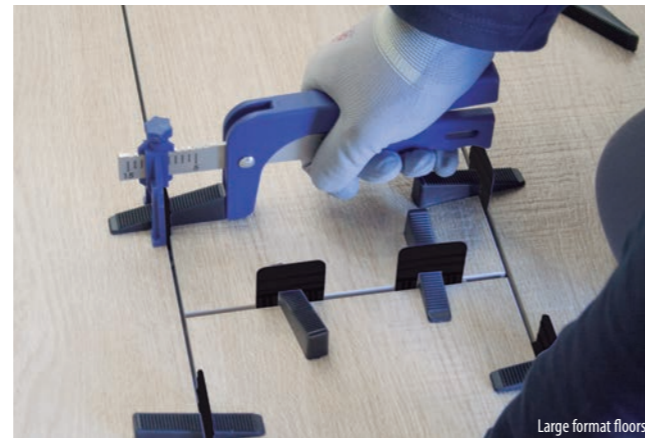

Large format floors

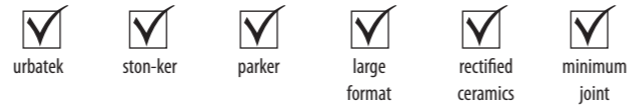

self-leveling spacers

Features:

- Guarantees tiles are even.
- Prevents tiles from moving due to laying errors or due to mortar setting.
- Reduces retouching and laying times.
- Suitable for 1-3 mm wide joints.
- Suitable for tiles 3 to 15 mm thick.
- The system consists of a spacer, a wedge and an adjusting tool.
- Wedges are recoverable, only the spacers are consumed.

Recommended uses:

- Wall and floor tiles with minimum joint.
- Large format floor tiles.
- Laying of rectified wall tiles.
- Tiles with reduced thickness: XLIGHT
- Interlocking floor designs.
- Glued facades.

Materials:

- All wall tiles and similar products laid with cement-based adhesives.
- Thickness between 3 and 15 mm.

Substrates:

- All usual substrates for ceramic tiles laying.

Coverage:

Tile	a x b mm	u/ m ²
Tile	200 x 316	64
Tile	316 x 446	29
Tile	316 x 596	22
Tile	316 x 900	15
Tile	316 x 316	41
Tile	446 x 446	21
Tile	435 x 659	18
Tile	596 x 596	17
Tile	800 x 800	13
Tile	450 x 900	15
Tile	596 x 1200	10
Par-ker	180 x 659	43
Par-ker	143 x 900	47
Par-ker	220 x 900	31
Par-ker	193x 1200	26
XLIGHT	1000 x 1000	8
XLIGHT	1000 x 3000	4



self-leveling spacers

KEA	SAP		P/EU
B83511063	100108031	wedge	20,23 p/bag
B83511062	100108032	wedge	46,91 p/bag
B83511056	100095383	wedge	89,12 p/bag

B83511059	100108026	1 mm spacer	14,14 p/bag
B83511058	100108027	1 mm spacer	38,65 p/bag
B83511065	100108028	1 mm spacer	63,48 p/bag

B83511061	100108029	2 mm spacer	14,14 p/bag
B83511060	100108030	2 mm spacer	38,65 p/bag
B83511057	100095382	2 mm spacer	63,48 p/bag

B83511067	100109070	3 mm spacer	14,14 p/bag
B83511066	100109071	3 mm spacer	38,65 p/bag
B83511070	100109072	3 mm spacer	63,48 p/bag

B83511072	100123264	supplementary lift piece	14,04 p/bag
-----------	-----------	--------------------------	-------------

KEA	SAP		P/EU
B83511064	100108034	1 mm spacer system kit	75,60 p/kit
B83511069	100109073	2mm spacer system kit	75,60 p/kit
B83511068	100109074	3mm spacer system kit	75,60 p/kit

KEA	SAP		P/EU
B83510071	100095386	pincers for self-leveling spacer	47,74 p/u

Products with special sale conditions

Packaging

Presentation	Packaging
100 units/bag	840 bags/pallet
300 units/bag	240 bags/pallet
500 units/bag	140 bags/pallet

100 units/bag	600 bags/pallet
300 units/bag	200 bags/pallet
500 units/bag	120 bags/pallet

100 units/bag	600 bags/pallet
300 units/bag	200 bags/pallet
500 units/bag	120 bags/pallet

100 units/bag	600 bags/pallet
300 units/bag	200 bags/pallet
500 units/bag	120 bags/pallet

50 units/bag	
--------------	--

Presentation
Kit
Kit
Kit

Presentation
Unit

s-107

S-107 is an acetic silicone putty for sealing joints. Specially recommended for sealing joints in bathrooms and for sealing perimeter joints in wall tile coverings. Indoor use.

Is a silicon rubber technical elastic joint sealant with acetic crosslinking. It polymerizes in contact with dampness becoming an elastomer highly elastic and resistant to atmospheric agents.

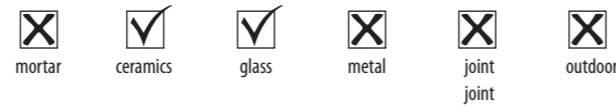

s-107

Features:

- Single-component acetic silicone.
- High elasticity.
- Good adherence.
- Resistant to UV rays.

Recommended uses:

- Sealing joints in ceramics, glass, plastics and painted surfaces.
- Sealing perimeter joints in wall tile coverings.
- Gluing ceramic materials on wood boards.

Coverage:

• 2 x 2 mm joint	75.0 m
• 3 x 3 mm joint	33.3 m
• 5 x 3 mm joint	20.0 m
• 5 x 5 mm joint	12.0 m
• 8 x 4 mm joint	8.3 m
• 8 x 6 mm joint	6.2 m

$$\text{Coverage (ml/cartridge)} = \frac{300}{\text{joint width (mm)} \times \text{joint depth (mm)}}$$

s-107

KEA	SAP		P/EU
B82301004	100005811	s-107 blanco	3,46 p/u
B82301005	100005812	s-107 transparente	3,46 p/u
B82301006	100005813	s-107 gris	3,46 p/u

Products with special sale conditions

Materials:

- Ceramic tiles and glass mosaic.
- Glass.
- Plastic material.
- Do not use with materials which are sensible to the action of acids, like marble or other natural stones.

Substrates:

- Do not use on substrates which are sensible to the action of acids:
 - Screeds and floors with cement mortar.
 - Concrete.

Packaging

Presentation	Packaging
300 ml cartridge	25 cartridges x box
300 ml cartridge	25 cartridges x box
300 ml cartridge	25 cartridges x box



s-107 n

S-107 n is a neutral silicone putty for sealing joints. Specially recommended for sealing movement joints. Indoor and outdoor use.,

This putty crosslinks in contact with dampness and does not give off odors, thus becoming an elastomer highly elastic and resistant to atmospheric agents.

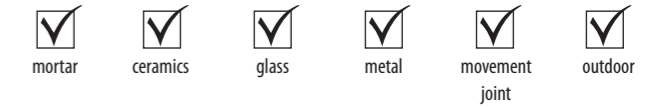

s-107 n

Features:

- Single-component neutral silicone.
- High elasticity.
- Good adherence.
- Resistant to UV rays.
- Frost-resistant.

Recommended uses:

- Sealing joints even between materials sensible to chemical attack.
- Sealing movement joints in floors and walls.
- Sealing joints in ceramics, glass, metal and plastics.
- Sealing perimeter joints in wall tile coverings.
- Gluing ceramic materials on wood boards.

Coverage:

• 2 x 2 mm joint	75.0 m
• 3 x 3 mm joint	33.3 m
• 5 x 3 mm joint	20.0 m
• 5 x 5 mm joint	12.0 m
• 8 x 4 mm joint	8.3 m

$$\text{Coverage (ml/cartridge)} = \frac{300}{\text{joint width (mm)} \times \text{joint depth (mm)}}$$

s-107 n

KEA	SAP		P/EU
B82302001	100005814	s-107_n blanco	5,26 p/u
B82302002	100005815	s-107_n transparente	5,26 p/u
B82302003	100005816	s-107_n gris	5,26 p/u
B82302004	100005817	s-107_n negro	5,26 p/u
B82600026	100115950	s-107_n beige	5,26 p/u
B82600035	100120606	s-107_n caramelo	6,59 p/u
B82600036	100120608	s-107_n antracita	6,59 p/u
B82600032	100120609	s-107_n bahama	6,59 p/u
B82600030	100120620	s-107_n cemento	6,59 p/u
B82600029	100120621	s-107_n marfil	6,59 p/u
B82600031	100120622	s-107_n marrón	6,59 p/u
B82600034	100120623	s-107_n moka	6,59 p/u
B82600028	100120624	s-107_n tabaco	6,59 p/u

Products with special sale conditions

Materials:

- Ceramic tiles and glass mosaic.
- Glass.
- Metal.
- Plastic material, PVC.
- Concrete slabs.
- Wood.

Substrates:

- All usual substrates for ceramic tiles laying.

Packaging

Presentation	Packaging
300 ml cartridge	25 cartridges x box
300 ml cartridge	25 cartridges x box
300 ml cartridge	25 cartridges x box
300 ml cartridge	25 cartridges x box
300 ml cartridge	25 cartridges x box
300 ml cartridge	25 cartridges x box
300 ml cartridge	25 cartridges x box
300 ml cartridge	25 cartridges x box
300 ml cartridge	25 cartridges x box
300 ml cartridge	25 cartridges x box
300 ml cartridge	25 cartridges x box
300 ml cartridge	25 cartridges x box
300 ml cartridge	25 cartridges x box
300 ml cartridge	25 cartridges x box
300 ml cartridge	25 cartridges x box
300 ml cartridge	25 cartridges x box
300 ml cartridge	25 cartridges x box
300 ml cartridge	25 cartridges x box
300 ml cartridge	25 cartridges x box
300 ml cartridge	25 cartridges x box
300 ml cartridge	25 cartridges x box



Before using this product in any application not indicated in this catalogue, please perform a test or refer to the product's technical sheet.

p-404

p-404 is polyurethane putty for sealing joints. Specially recommended for sealing movement joints outdoors. Indoor and outdoor use.

This reticular putty in contact with dampness does not give off odors, thus becoming an extraordinary adherent, elastic and resistant elastomer to atmospheric agents.



p-404

Features:

- Single-component polyurethane putty.
- High elasticity.
- High adherence.
- Resistant to UV rays.
- Frost-resistant.

Recommended uses:

- Sealing joints even between materials sensible to chemical attack.
- Sealing movement joints in floors and walls.
- Bonding of building materials like ceramics, concrete, roof tiles, wood, aluminium, polyester or PVC.
- Gluing ceramic materials on metal or wood boards.
- Gluing Concept XPS panels.

Coverage:

• 2 x 2 mm joint	77.5 m
• 3 x 3 mm joint	31.4 m
• 5 x 3 mm joint	20.6 m
• 5 x 5 mm joint	12.4 m
• 8 x 4 mm joint	8.6 m
• 8 x 6 mm joint	6.4 m

$$\text{Coverage (ml/cartridge)} = \frac{310}{\text{joint width (mm)} \times \text{joint depth (mm)}}$$

Materials:

- Ceramic tiles and glass mosaic.
- Glass.
- Metal.
- Plastic material, PVC.
- Concrete slabs.
- Wood.
- Concept XPS panels.

Substrates:

- All usual substrates for ceramic tiles laying.

Packaging

Presentation	Packaging
310 ml cartridge	25 cartridges x box
310 ml cartridge	25 cartridges x box
310 ml cartridge	25 cartridges x box



p-404

KEA	SAP		P/EU
B82401001	100005818	p-404 blanco	6,32 p/u
B82401002	100005819	p-404 gris	6,32 p/u
B82401003	100005820	p-404 negro	6,32 p/u

cl-stuk

cl-stuk is a latex which mixed with cement-based grouts like **colorstuk n**, reduces water absorption and enhances mechanical resistance and deformability. Specially recommended when laying ceramic outdoors and in permanently damp environments.

A latex additive that can be mixed with the **colorstuk** range of high-tech grout mortars in cases when increased mechanical resistance, reduced water absorption or improved flexibility is required.



cl-stuk

Features:

- Water-based acrylic resins latex.
- Resistant to the most common chemicals.
- It reduces mortar water absorption.
- It enhances the adherence and deformability of the grouting material.
- It increases resistance to abrasion.
- Excellent resistance to UV rays and the effect of heat.
- Frost-resistant.

Recommended uses:

- Specially recommended in:
- Outdoor floor and wall tiles.
 - High traffic floor tiles.
 - Floor tiles on radiant heating.
 - Pools and damp environments.
- It enhances grouting material performance in:
- Indoor wall tile coverings. Specially recommended for rectified tiles.
 - Indoor floor tiles, including public buildings.

Coverage:

Product	%	liters	Kg/bag
Colorstuk 0-4 n white	34%	1.6-1.8	5
Colorstuk 0-4 n white	34%	8.2 - 8.8	25
Colorstuk 0-4 n color	26%	1.2-1.4	5
Colorstuk 0-4 n color	26%	6.4-6.6	25
Colorstuk 2-12 n	20%	0.9-1.1	5
Colorstuk 2-12 n	20%	4.8 - 5.2	25
Colorstuk especial n	32.5%	0.65	2

Materials:

- Specially recommended in:
- Wall tiles with mosaic-like patterns.
 - DQS slabs and other kinds of marble agglomerate.
- It enhances grouting material performance in:
- Absorbent and non-absorbent ceramic tiles, including porcelain tiles.
 - Glass mosaic.
 - Natural stone and marble not prone to staining.

Substrates:

- All usual substrates for ceramic tiles laying.

cl-stuk

KEA	SAP		P/EU
B51201001	100004374	cl-stuk	3,18 p/kg
B51501001	100004375	cl-stuk	2,49 p/kg

Packaging

Presentation	Packaging
2 kg can	448 kg/pallet
5 kg can	480 kg/pallet





Substrate preparation products

Acoustic insulation

fonopac R 119

Electric Radiant Floor Heating

Electric Radiant Floor Heating 121

Mortar additive

unicem 123

thermocem 124

Self-leveling mortars

level 1 n 125

level 1 pro 126

level 3 127

Primer

uniprim 128

super-prim 129

Cleaning products

acid net pro 130

acid net + 131

acid net 1L 131

basic gel 1L 131

porce-clean 132

colorstuk cleaner 132

epotech cleaner 132

colorstuk sealer 133

non slip tile 133

fonopac R

fonopac R is a multilayer sheet for isolating ceramic or natural stone floors against impact noise. Made of synthetic rubber, it combines a good Acoustic insulation with a low compressibility, allowing for direct laying of ceramic tiles. Specially recommended for refurbishing of floors.

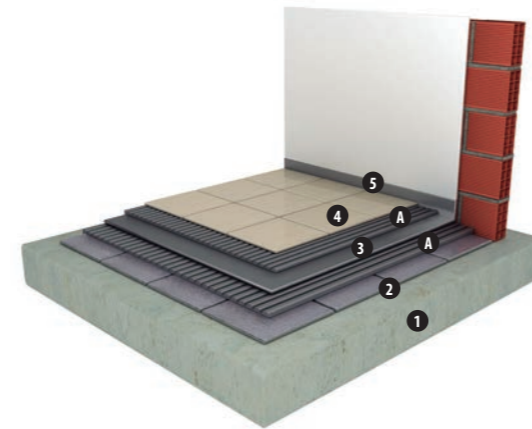

1- floor slab
2- old floor tile
3- fonopac R
4- floor tile
5- bandin
A- cement-based adhesive + fonolax

fonopac R

Features:

- Sheet made of synthetic rubber and TPO..
- Allows direct laying of tiles, with no need for compression layers.
- Compatible with cement-based adhesives.
- Dimensions: 60 x 100 cm
- Final thickness: 3 mm
- Weight: 1,42 kg/m²
- Weighted reduction of impact sound pressure level according to standard ISO 717-2

$$\Delta L_w = 16 \text{ dB}$$

Installation:

- Cover the whole floor perimeter with acoustic isolating tape **bandin**.
- Laying of the sheets by the thin-bed method, with **super-one n** adhesive mixed with **fonolax**.
- Seal the joints between sheets with **cintex** tape.
- Be extremely cautious when laying the sheet to avoid tears and other acoustic bridges.
- Once **fonopac R** sheets laid, lay the ceramic floor with **super-one n** mixed with **fonolax**.

Recommended uses:

- Reduces impact noise in indoor floors.
- Reduces impact noise in refurbishing of floors.

Materials:

- Ceramic floors and similar products adhered to the substrate.
- Laminate floors.

Substrates:

- Cement covered floors.
- Existing wall tiles.

fonopac R

KEA	SAP	P/EU
B67900038	100082628	fonopac R 17,41 p/m ²
B61901006	100004402	bandin 17,58 p/u
B61901001	100004399	cintex 22,63 p/u
B64902002	100004463	fonopac R kit contents 329,38 p/u
B67900038	100082628	fonopac R
B12909011	100031189	super-one n gris
B52502001	100004385	fonolax
B61901006	100004402	bandin
B61901001	100004399	cintex

Packaging

Presentation
100 x 60 cm sheets
20 m reel
50 m reel
Total 8.4 m ²
14x 100x60 cm sheets
2x 25 kg bags
1x 5 kg can
1x 20 m reel
1x 50 m reel

Before using this product in any application not indicated in this catalogue, please perform a test or refer to the product's technical sheet.



electric radiant floor heating

The **electric radiant floor heating** from **butech**, also known as **ERFH**, is a heating system with an electric element for radiant floors, specially designed to provide comfort in ceramic floors in bathrooms and, in general, all kinds of floors walked barefoot. The **ERFH** system consists of an electric element and a digital thermostat timer.

The electric element is a 5 mm diameter heating wire that transforms electric energy into heating. Never cut this kind of wire. Maximum power is 150 W/m².

User-friendly digital thermostat that regulates the turn on and off and heating power of the system.



- indoor
- outdoor
- new building work
- refurbishing homes
- bath environments
- living rooms

electric radiant floor heating

Features:

- Easy, quick and economic installation. No maintenance costs.
 - Avoids the installation of radiators on the walls.
 - Ideal for homes not connected to the gas distribution network.
 - Applicable in floors where a water pipe heating cannot be installed.
 - More uniform heat distribution to all the surface of the room.
 - More pleasant elevation of heat distribution.
 - No air movement.
- Voltage: 230 V – 50/60 Hz
 - Maximum charge: 16 Amp / 230 V max
 - Maximum temperature: + 40°C

Installation:

- Professional heating system. Please contact authorized electrical installers.
- Choose the radiant mesh that suits the surface to be heated.
- In case of surfaces bigger than 10 m², connect meshes in parallel in a connection box.
- Do not connect meshes with a total surface bigger than 20 m² to one thermostat.
- Never cut the heating wire.
- Do not install under static elements and less than 10 cm from the walls.
- Never drill a floor where a radiant heating has been installed.

Guarantee:

- Thermostat guarantee: 2 years
- Electric mesh guarantee: 10 years

Recommended uses:

- Radiant heating in home refurbishings.
- General heating of homes.
- Comfort and auxiliary heating in bathrooms and dressing rooms.
- Comfort and auxiliary heating in spas and premises with permanent dampness.
- Comfort and auxiliary heating in locker rooms, recreational and sports premises.
- Heating of indoor areas with high ceilings.
- Temporary heating of workplaces.
- Do not use in outdoor floors.

Materials:

- Absorbent ceramics and porcelain tiles (water absorption < 0.5% as per EN-ISO 10545-3).
- Natural stone and marble not prone to staining.
- Wooden floors bonded to the substrate.
- Do not use under floating floors.
- Do not use under material sensible to heat.

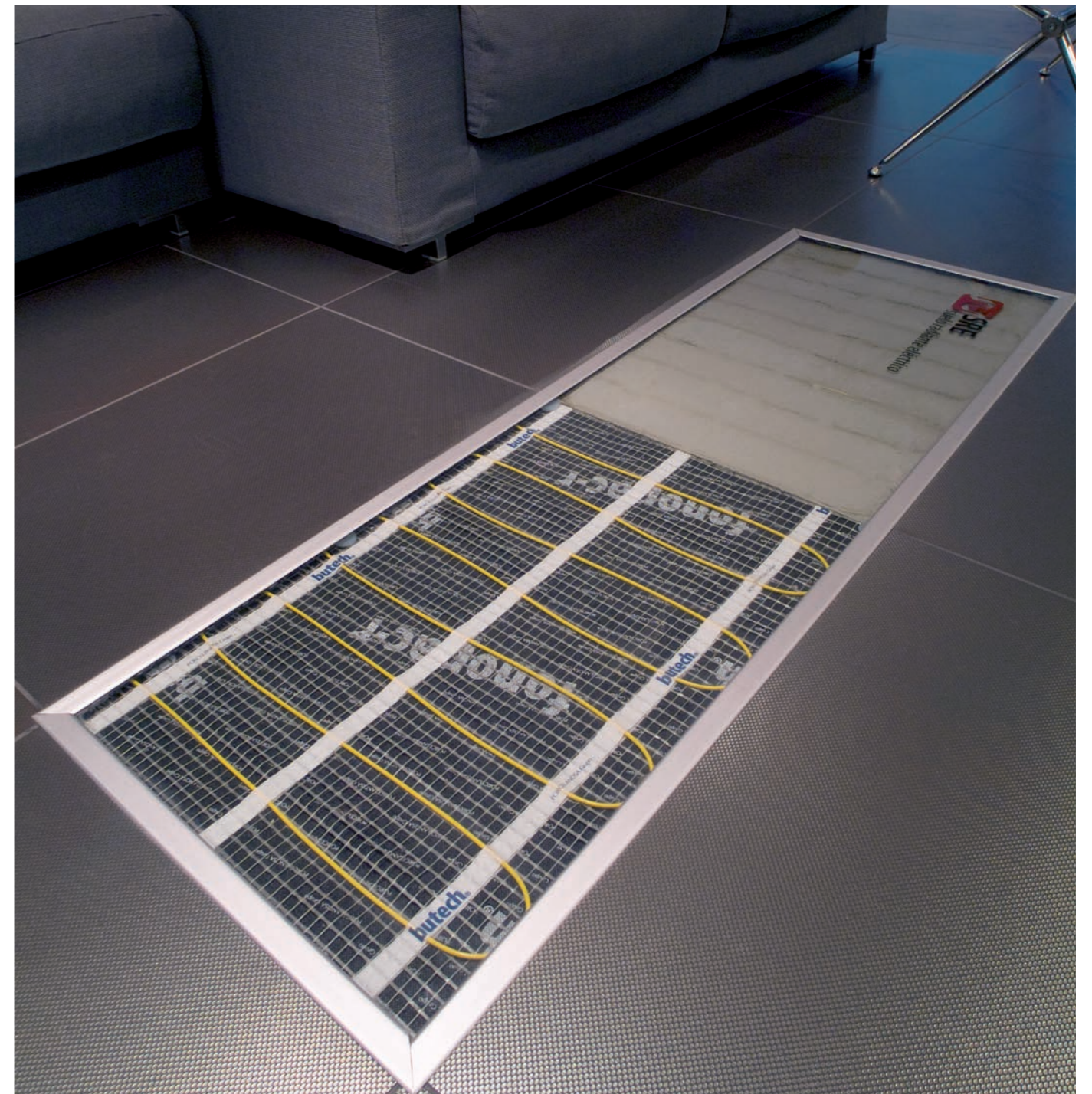
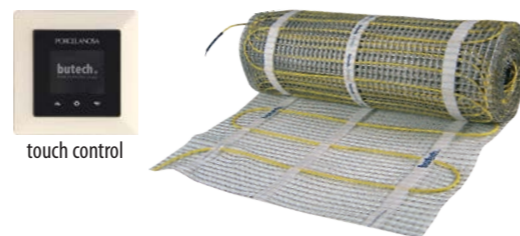

electric radiant floor heating

KEA	SAP	electric radiant floor heating	P/EU
B62902151	100086601	ERHF 1 m ² (150w) n	169,52 p/u
B62902162	100086615	ERHF 2 m ² (150w) n	239,79 p/u
B62902158	100086617	ERHF 3 m ² (150w) n	322,14 p/u
B62902161	100086619	ERHF 4 m ² (150w) n	398,99 p/u
B62902157	100086621	ERHF 5 m ² (150w) n	459,38 p/u
B62902154	100086623	ERHF 6 m ² (150w) n	503,30 p/u
B62902163	100086625	ERHF 7 m ² (150w) n	580,15 p/u
B62902166	100086627	ERHF 8 m ² (150w) n	657,00 p/u
B62902135	100073467	ERHF 10 m ² (150w) n	642,29 p/u
B62902168	100155713	ERFH touch control thermostat	166,44 p/u
B62901102	100004419	ERHF repair kit	15,90 p/u

Packaging

Contents	Presentation
only mesh	1 mesh/box
only mesh	1 mesh/box
only mesh	1 mesh/box
only mesh	1 mesh/box
only mesh	1 mesh/box
only mesh	1 mesh/box
only mesh	1 mesh/box
only mesh	1 mesh/box
only mesh	1 mesh/box
only mesh	1 mesh/box
only thermostat	1 thermostat/box
	1 kit/box

unicem

unicem is a latex that enhances the overall mechanical performance of cement-based mortars. Specially recommended for cement rendering, floor screeds and other applications in outdoor environments.

It guarantees increased waterproof protection, cohesion, reduced deformability and resistance to atmospheric agents of cement-based substrates. Recommended for intermediate bond coats between mortars.



- intermediate bond coat
- floor tile outdoor
- radiant heating
- high traffic
- pools
- facades

unicem

Features:

- Water dispersion synthetic resins latex.
- Excellent resistance to dampness.
- Good deformability.
- Excellent resistance to UV rays and the effect of heat.
- Frost-resistant.

Recommended uses:

- Outdoor wall and floor tiles. Specially recommended in facades
- Floor tiles on radiant heating.
- High traffic floor tiles.
- Pools and environments with a strong water presence.
- Making of fully bonded screeds.

Coverage:

Substrate	Coverage
Mortar screed	
• < 10 mm	150 gr/m ² and thickness millimeter
• 10-35 mm	50 gr/m ² and thickness millimeter
• > 35 mm	30 gr/m ² and thickness millimeter
Mortar rendering	70 gr/m ² and thickness millimeter
Bond coat	200 - 300 gr/m ²

Materials:

- All wall tiles and similar products to be laid with cement-based adhesives.

Substrates:

- Stable structures.

Packaging

Presentation	Europallet
5 kg can	480 kg/pallet
20 kg can	560 kg/pallet



unicem

KEA	SAP		P/EU
B51603002	100004378	unicem	4,69 p/kg
B51604002	100004379	unicem	4,28 p/kg

Thermocem

Thermocem is a single component cement mortar modified with polymers for bonding and rendering the polystyrene boards used in external thermal insulation systems: SATEc / ETICSc (Building Regulations)

Thermocem is formulated from a special dry cement, with aggregate granules less than 0.5 mm, resins and special additives. Suitable for render finishes of 2 to 4mm thickness. Professional use.



- Extruded polystyrene
- Expanded polystyrene
- Ceramic tiles
- Exteriors
- Impermeable
- SATE

Thermocem

Specification:

- Single component mortar.
- Excellent adhesion.
- As render - thickness of application between 2 and 4mm (two layers)
- Easy application with smooth trowel or spatula.
- Internal or external use.
- Water for mixing. 21±1%: 5.0 - 5.5 litres / 25 kg bag.

Recommended applications:

- Intermediate layer in SATEc / ETICSc systems
- Installation of expanded polystyrene boards on commonly used construction fixings.
- Installed using a fiberglass mesh, expanded polystyrene board surface reinforcement.
- External insulation on ventilated façades.

Use:

- Use as adhesive: Toothed trowel 10 x 10 5.0 – 6.0 kg / m²
- Use as render or screed: 1.3 – 1.4 kg / m²

Materials:

- Expanded polystyrene boards

Fixings:

- Use as adhesive:
- Cement mortar.
 - Concrete slabs.
 - Masonry works

Thermocem

KEA	SAP		P/EU
B12909018	100144968	Thermocem	0,70 p/kg

Packaging

Delivery	Box
25Kg Bag	1200 Kg/pallet



level 1 n

level 1 n is a fast hardening, self-leveling mortar for leveling and regularizing substrates for all kinds of floor tiles. 2 to 10 mm thickness. Specially recommended for laying ceramic floor tiles with a minimal joint indoors.

It is formulated for creating 2 to 10 mm floor substrates. It features good workability, fast-setting times, and a high mechanical performance. It allows to prepare floors well levelled, for a correct and quick fixing of rectified ceramic tiles



Large format floors



level 1 n

Features:

- Compressive strenght $\geq 30 \text{ N/mm}^2$
- Flexural strenght $\geq 7 \text{ N/mm}^2$
- Single-component, self-leveling mortar.
- Excellent adherence. Flexible.
- Application thickness between 2 and 10 mm.
- Easy application with a straight edge trowel or scraper.
- Indoor use.
- Mixing water: 5,75 l per 23 kg bag

Recommended uses:

- Substrate regularization in refurbishing jobs.
- Indoor large format floor tile coverings.
- Indoor large format rectified floor tile coverings.
- Indoor floor tile coverings with a 1 mm joint.
- Floor tiles with radiant heating.

Coverage:

Substrate	Coverage
Self-leveling floors	1,4 kg/m ² and thickness millimeter

Materials:

- Large format ceramics.
- Porcelain tiles with a water absorption $< 0.5\%$ as per EN-ISO 10545-3.
- Glass mosaic.
- Natural stone and marbles.

Certifications/Standards:

EN 13813 CT C30-F7

Priming:

- Cement-based substrate, previously apply **uniprim**.
- Glazed ceramic tiles, previously apply **super-prim**.

level 1 n

KEA	SAP	P/EU
B15901002	100048841	level 1 n 0,99 p/kg

Packaging

Presentation	Europallet
23 kg bag	920 kg/pallet



Before using this product in any application not indicated in this catalogue, please perform a test or refer to the product's technical sheet.

level 1 pro

level 1 pro is a fast hardening, self-leveling mortar for leveling and regularizing substrates for all kinds of floor tiles. 2 to 10 mm thickness. Specially recommended for laying rectified ceramic floor tiles.

It is formulated for creating 2 to 10 mm floor substrates. It features good workability, fast-setting times, and a high mechanical performance. It allows to prepare floors well levelled, for a correct and quick fixing of rectified ceramic tiles



Large format floors

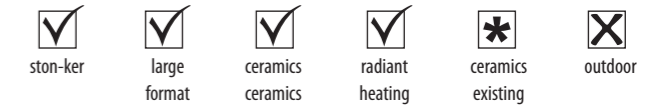

level 1 pro

Features:

- Single-component, self-leveling mortar.
- Excellent adherence.
- Fast hardening. Ready for traffic in 4-5 hours.
- Application thickness between 2 and 10 mm.
- Easy application with a straight edge trowel or scraper. Pumpable.
- Indoor use.
- Mixing water. 6.0 l per 25 kg bag.

Recommended uses:

- Substrate regularization in refurbishing jobs.
- Indoor large format ceramic floor tile coverings.
- Indoor rectified floor tile coverings.
- Indoor floor tile coverings with a 1 mm joint.
- Laminate floating floors.
- Synthetic floors and carpet.
- Do not use in outdoor floors.

Coverage:

Substrate	Coverage
Self-leveling floors	1.4 kg per m ² and thickness millimeter

Materials:

- Large format ceramics.
- Porcelain tiles with a water absorption $< 0.5\%$ as per EN-ISO 10545-3.
- Natural stone and marble not prone to staining.
- Laminate floors and parquet.

Certifications/Standards:

EN 13813 CT-C20-F5

Primer:

- For cement-based, concrete or anhydrite substrates, first apply **uniprim**.
- For existing ceramic substrates, first apply **super-prim**.

level 1 pro

KEA	SAP	P/EU
B15901005	100141151	level 1 pro 0,67 p/kg

Packaging

Presentation	Europallet
25 kg bag	1000 kg



Before using this product in any application not indicated in this catalogue, please perform a test or refer to the product's technical sheet.

level 3

level 3 is a fast hardening, self-leveling mortar with fibres for leveling and regularizing substrates for all kinds of floor tiles. 3 to 30 mm thickness. Specially recommended for laying ceramic floor tiles with a minimal joint indoors.

It is formulated for creating 3 to 30 mm floor substrates. It features good workability, fast-setting times, and a high mechanical performance. It allows to prepare floors well levelled, for a correct and quick fixing of rectified ceramic tiles



level 3

Features:

- Compressive strength $\geq 25 \text{ N/mm}^2$
- Flexural strength $\geq 5 \text{ N/mm}^2$
- Single-component, self-leveling mortar.
- Excellent adherence. Flexible.
- High fibre content.
- Application thickness between 3 and 30 mm.
- Easy application with a straight edge trowel or scraper.
- Indoor use.
- Mixing water: 4.25 – 4.50 l per 25 kg bag

Recommended uses:

- Indoor large format floor tile coverings.
- Indoor large format rectified floor tile coverings.
- Indoor floor tile coverings with a 1 mm joint.
- Floor tiles with radiant heating.

Coverage:

Substrate	Coverage
Self-leveling floors	1,4 kg/m ² and thickness millimeter

Materials:

- Large format floor tiles.
- Porcelain tiles (water absorption < 0.5% as per EN-ISO 10545-3).
- Natural stone and marbles.

Certifications/Standards:

EN 13813 CT C25-F5

Priming:

- Cement-based substrate, previously apply **uniprim**.
- Glazed ceramic tiles and wood substrates, previously apply **super-prim**.

level 3

KEA	SAP	P/EU
B15901004	100104577	level 3 1,07 p/kg

Packaging

Presentation	Europallet
25 kg bag	1000kg/pallet



uniprim

uniprim is a water-based primer made of synthetic resins for the insulation of plaster, anhydrite and molding plaster substrates, prior to the use of cement-based adhesives. It reduces water absorption and improves the consistency of cement-based substrates

C2-type cement-based adhesives can be used to lay ceramic tiles quickly and efficiently on plaster, anhydrite and molding plaster substrates. It reduces the level of absorption of highly absorbent substrates, preventing cement-based adhesives from drying out too quickly and thus ensuring that they set properly. Priming prior to the application of self-leveling mortars on absorbent substrates, avoiding the appearance of bubbles or cracks because of a fast drying.



uniprim

Features:

- Water-based synthetic resins primer.
- Once dry, it leaves a film over the substrate, which in plaster-based substrates prevents contact and chemical reaction with cement-based adhesives. It prevents ettringite buildup.
- It reduces substrate water absorption.
- It improves the bonding material setting time.
- It increases cohesion of the substrate.
- Easy application with a paint roller or a wide paintbrush.
- Indoor and outdoor use.

Recommended uses:

- Wall tiles on plaster or molding plaster substrates.
- Floor tiles on anhydrite substrates.
- Ceramic tiles on cement-based substrates with weak consistency.
- Reinforcement of self-leveling mortars.

Coverage:

Substrate	Coverage
Anhydrite/plaster substrate	100 - 200 gr/m ²

Materials:

- All wall tiles and similar products to be laid with cement-based adhesives.

Substrates:

- Plasterboards and plastered walls.
- Anhydrite floor coverings.
- Cement-based substrates with high water absorption.
- Plasterboards.
- Untreated partition walls for laying tiles.

Packaging

Presentation	Europallet
5 kg can	480 kg/pallet
20 kg can	560 kg/pallet



super-prim

superprim is a water-based acrylic resin primer with silica arids, used for preparing substrates prior to using adhesives, self-leveling mortars and mortar screeds. It reduces water absorption and improves the consistency of cement-based substrates. Professional use.

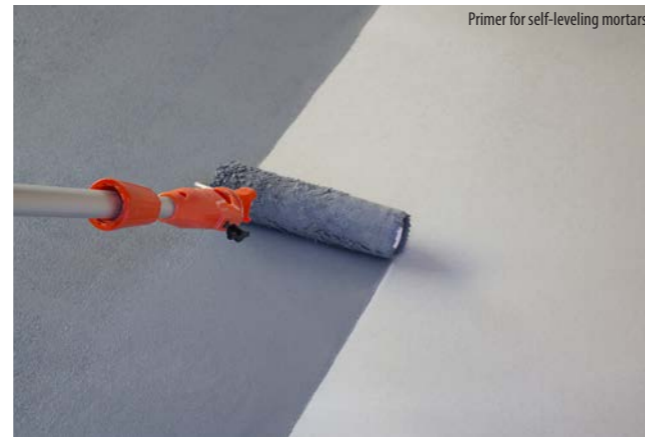

- mortar
- plaster or anhydrite
- existing ceramics
- wood
- metal
- self-leveling mortar

super-prim

Features:

- Water-based, acrylic resin latex with silica arids.
- It enhances the adherence of cement mortars on glazed wall coverings.
- It improves the bonding material setting time.
- It reduces substrate water absorption.
- It increases cohesion of the substrate.
- Easy application with a paint roller or a wide paintbrush. Can be applied with airless spray.
- Indoor and outdoor use.
- Do not dilute with water or mix with any other liquids.

Coverage:

Substrate	Coverage
Non absorbent	200 - 250 gr/m ²
Absorbent	250-300 gr/m ²

super-prim

KEA	SAP	P/EU
B57500002	100123220	super-prim 7,35 p/kg

Recommended uses:

- Primer for self-leveling mortars on highly absorbent or existing ceramic tile coverings.
- Ceramic tiles on cement-based substrates with weak consistency or existing ceramic tile coverings.
- Ceramic floor coverings on anhydrite substrates or ceramic wall coverings on plaster or molding plaster.
- Mortar screeds on brick partition walls or concrete block walls.
- Mortar screeds on ceramic tile or natural stone floors.
- Do not use in substrates subject to dampness increases.

Materials:

- All wall tiles and similar products to be laid with cement-based adhesives.

Substrates:

- Ceramic brick partition walls.
- Cement covered floors and walls.
- Concrete slabs and aerated concrete blocks.
- Anhydrite-covered floors and plastered walls.
- Indoor ceramic floor and wall tiles.
- Indoor wood boards.
- Indoor metal sheets.

Packaging

Presentation	Box
10 kg can	480 kg/pallet



Before using this product in any application not indicated in this catalogue, please perform a test or refer to the product's technical sheet.

acid net pro

acid net pro is an acid detergent for cleaning ceramic floor and wall tiles. Specially recommended for cleaning building debris. Indoor and outdoor use.

It is an acid solution that in contact with cement reacts and removes dirt or stains without damaging coverings or cement based joints like **colorstuk**. Suitable for removing saltpetre remains or dirt sensible to acid attack.



- wall tile
- floor tile
- floor tile porcelain tile
- glass mosaic
- natural
- special glazes

acid net pro

Features:

- Acid solution.
- Colorless liquid.
- pH < 0.1
- Viscosity: 5.0 - 8.0 cp at 20°C
- Recommended action time: 10-15 min.

Coverage:

Dilution	
1 : 1 with clear water	90-100 gr/m ²
1 : 2 with clear water	45-50 gr/m ²
1 : 3 with clear water	25-35 gr/m ²
1 : 5 with clear water	20 gr/m ²

Certifications/Standards:

CAS No.: 7664-38-2
 Phrases: R-34
 S2, S26, S36/37/39, S45
 Danger symbols: C

acid net pro

KEA	SAP	P/EU
B31202002	100004342	acid net pro 9,70 p/kg
B31502002	100004347	acid net pro 9,32 p/kg

Recommended uses:

- Building site final cleaning.
- Cleaning of remains of adhesives and cement-based grouting materials in floor and wall tiles.
- Cleaning of efflorescences and salts remains.
- Cleaning of lime remains and film.
- Cleaning of glazed substrates prior to laying new tiles.

Materials:

- Ceramic glazed and non-glazed tiles GLA, ULA.
- Glass mosaic.
- Natural stones resistant to acid descalers.
- It is not recommended to use **acid net** in materials sensible to acid cleaners like:
 - Marbles and natural limestones.
 - Ceramic tiles with surface finishes sensible to acid attack, like polished or metallic finishes.

Substrates:

- Do not apply directly on:
 - Cement covered floors and walls .
 - Concrete slabs.

Packaging

Presentation	Europallet
2 kg can	448 kg/pallet
5 kg can	480 kg/pallet



*Given the wide variety of ceramic materials, we recommend to check with your tile provider about chemical resistance to acid attack.

Before using this product in any application not indicated in this catalogue, please perform a test or refer to the product's technical sheet.

acid net +

acid net + is a concentrated descaler for cleaning ceramic floor and wall tiles. Specially recommended for cleaning building debris. Indoor and outdoor use.

Recommended uses:

- Building site final cleaning.
- Cleaning of remains of adhesives and cement-based grouting materials in floor and wall tiles.
- Cleaning of efflorescences and salts remains.
- Cleaning of plaster remains and plaster-based remains.
- Cleaning of lime remains and film.
- Cleaning of glazed substrates prior to laying new tiles.

acid net +

KEA	SAP	P/EU
B35200004	100120424	acid net +
		11,64 p/u



Coverage:

Dilution 1: 1 with clear water	90-100 gr/m ²
Dilution 1: 2 with clear water	45-50 gr/m ²

Packaging

Presentation	Box
1000 ml bottle	12 bottles



acid net 1L

acid net is an acid detergent for cleaning ceramic floor and wall tiles. It dissolves all kinds of cement debris without damaging coverings or cement based joints like **colorstuk**.

Recommended uses:

- Cleaning of remains of adhesives and cement-based grouting materials in floor and wall tiles.
- Cleaning of efflorescences and salts remains.
- Cleaning of plaster remains and plaster-based remains.
- Cleaning of lime remains and film.
- Cleaning of glazed substrates prior to laying new tiles.

acid net 1L

KEA	SAP	P/EU
B35200003	100120423	acid net
		9,70 p/u

Coverage:

Dilution 1: 1 with clear water	90-100 gr/m ²
Dilution 1: 2 with clear water	45-50 gr/m ²

Packaging

Presentation	Box
1000 ml bottle	12 bottles



basic gel 1L

Concentrated alkaline detergent developed for cleaning ceramic tiles in general, terracotta and antiqued marble. It removes all kinds of oils, varnishes, paints, wax and home stains. Specially effective for etching former treatments.

Recommended uses:

- Intensive cleaning of ceramic wall tiles.
- Cleaning of remains of wax, oil or grease from floor and wall tiles.
- Cleaning of glazed substrates prior to laying new tiles.

basic gel 1L

KEA	SAP	P/EU
B35200005	100120425	basic gel 1000 ml
		11,56 p/u

Coverage:

Dilution 1: 1 with clear water	85-100 ml / m ²
Dilution 1: 2 with clear water	40-50 ml / m ²

Packaging

Presentation	Box
1000 ml bottle	12 bottles

porce-clean

Neutral detergent for cleaning ceramic and natural stone floor coverings. High degreasing power for a deep and perfect cleaning. Fast drying. Indoor and outdoor use.

Recommended uses:

- Regular cleaning of ceramic wall tiles.
- Cleaning of remains of wax, oil or grease from floor and wall tiles.

porce-clean

KEA	SAP	P/EU
B35200008	100120431	porce-clean
		8,64 p/u



Coverage:

10 l of clean water	100-200 ml
---------------------	------------

Packaging

Presentation	Box
1000 ml bottle	12 bottles

colorstuk cleaner

Cleaner for cement based grouts. It removes dirt build-up and recovers the grout's original color. Specially recommended for maintenance of joints sealed with **colorstuk**.

Recommended uses:

- Cleaning of cement based joints stained with dust and dirt.
- Recovering the color in cement based tiling joints.

colorstuk cleaner

KEA	SAP	P/EU
B35200007	100120426	colorstuk cleaner
		10,20 p/u



Coverage for 2 mm joint.

Tile	200 x 316 cm	20 m ² /package
Tile	316 x 596 cm	33 m ² /package
Tile	316 x 900 cm	37 m ² /package
Tile	446 x 446 cm	35 m ² /package
Tile	446 x 660 cm	42 m ² /package
Tile	596 x 596 cm	47 m ² /package

Packaging

Presentation	Box
125 ml package	12 applicators

epotech cleaner

Water-based detergent for cleaning epoxy putties remains and stains. Specially recommended for cleaning remains of **epotech aqua**. Professional use.

Recommended uses:

- Cleaning of epoxy putties remains and films on ceramic tiles, glass mosaics and natural stones.

epotech cleaner

KEA	SAP	P/EU
B35200006	100120428	epotech cleaner
		18,11 p/u



Coverage for 2 mm joint.

Tile	200 x 316 cm	20 m ² /package
Tile	200 x 446 cm	30 m ² /package
Tile	316 x 596 cm	33 m ² /package
Tile	316 x 900 cm	37 m ² /package

Packaging

Presentation	Box
500 ml bottle	20 bottles

*Given the wide variety of ceramic materials, glass mosaics and natural stones, we recommend to check with your tile provider about chemical resistance of the tiles before applying any cleaning product.

Before using any cleaning product, please perform a test or refer to the product's technical sheet.

*Given the wide variety of ceramic materials, glass mosaics and natural stones, we recommend to check with your tile provider about chemical resistance of the tiles before applying any cleaning product.

Before using any cleaning product, please perform a test or refer to the product's technical sheet.

colorstuk sealer

Colorless, waterproof protector for cement based joints. It coats in depth and strengthens the grout. It protects against water, oils and accidental spills. It eases the cleaning of joints as it reduces water absorption.

Recommended uses:

- Sealing and protection for cement based grouts.



Coverage for 2 mm joint.

Tile	200 x 316 cm	40 m ² /package
Tile	316 x 596 cm	65 m ² /package
Tile	316 x 900 cm	74 m ² /package
Tile	446 x 446 cm	70 m ² /package
Tile	446 x 660 cm	83 m ² /package
Tile	596 x 596 cm	94 m ² /package

Packaging

Presentation	Box
125 ml package	16 applicators

colorstuk sealer

KEA	SAP	P/EU
B87010002	100120427	colorstuk sealer

non-slip tile

Non-slip treatment for glazed and unglazed ceramic tiles reducing the risk of slip and fall accidents. Indoor and outdoor use.

The non-slip treatment reacts with the ceramic tiles surface, generating thousands of microscopic bowls. These evenly distributed engravings increase the contact surface and, in the presence of water, produce a suction between the covering and the foot. This effect increases the coefficient of friction and reduces the risk of slip and fall accidents.

Recommended uses:

- Glazed and non-glazed ceramic floor tile coverings.
- Indoor and outdoor floor tile coverings.
- Built in shower trays.
- Do not apply on fibre shower trays and bathtubs.
- Do not apply on materials which are sensible to acid attack, like limestones or mortar substrates.



Coverage

Ceramic tile	200 gr
--------------	--------

Packaging

Presentation	Box
500 ml bottle	20 bottles

non-slip tile

KEA	SAP	P/EU
B33601002	100120430	non slip tile

	Glass mosaic	Glazed ceramic tiles	Porcelain
Remains of building work	acid net +	acid net +	acid net +
Cement	acid net	acid net	acid net
Gypsum	acid net	acid net	acid net
Epoxy putty	epotech cleaner	epotech cleaner	epotech cleaner
Remains of silicone	Vitroceraic scraper + Acetone	Vitroceraic scraper + Acetone	Vitroceraic scraper + Acetone
Efflorescence	acid net	acid net	acid net
Moss	Bleach	Bleach	Bleach

Daily maintenance	porce-clean	porce-clean	porce-clean
Food	porce-clean	porce-clean	porce-clean
Coffee, juices, sodas	basic gel	basic gel	basic gel
Lemon, vinegar	basic gel	basic gel	basic gel
Rust stains	acid net	acid net	acid net
Urine and vomit	acid net	acid net	acid net

Merbromin	Hydrogen peroxide	Hydrogen peroxide	Hydrogen peroxide
Iodine dye	Hydrogen peroxide	Hydrogen peroxide	Hydrogen peroxide
Macchie di sangue	Hydrogen peroxide	Hydrogen peroxide	Hydrogen peroxide

Oil, fat	basic gel	basic gel	basic gel
Motor oil	basic gel	basic gel	basic gel
Tar	Acetone	Acetone	Acetone
Paint, varnish, markers	Acetone	Acetone	Acetone
Adhesive and glue	Acetone	Acetone	Acetone
Rubber tires	Acetone	Acetone	Acetone

Waterproofing joints	colorstuk sealer	colorstuk sealer	colorstuk sealer
Joints cleaner	colorstuk cleaner	colorstuk cleaner	colorstuk cleaner
Anti-slip			non-slip tile

Given the wide range of mosaics and ceramics, it is recommended to consult the supplier of tiles about the chemical resistance. In any case, it is recommended to take a test.

We recommend the use on cleaning polished tiles, also with metal finish. Contact the supplier of tiles to know the chemical resistance. In any case, you have to take a test.

*Given the wide variety of ceramic materials, glass mosaics and natural stones, we recommend to check with your tile provider about chemical resistance of the tiles before applying any cleaning product.

Before using any cleaning product, please perform a test or refer to the product's technical sheet.



Waterproofing

Waterproofing

imperbox	137
imperband	139
bathroom drain	140
imperband standard kit	141
imperband refurbishing kit	142
linear grids	143
squared grids	144
sylastic	145
terrace drain	146

Decoupling and waterproofing

lamitech n	147
------------	-----

Drainage

super drain	148
-------------	-----

imperbox

imperbox is paste, ready-to-use waterproofing system specially recommended for waterproofing plasterboard indoors. Compatible with type C2 cement-based adhesive as per EN 12004. Indoor use.

Paste with water-dispersed acrylic polymers that provide it with excellent bonding and deformability properties, which means it can be used over the most common types of substrates used in construction. Special pieces and bands available for waterproofing joints and other critical spots.



- | | | | | | |
|-------------------------------------|-------------------------------------|-------------------------------------|-------------------------------------|-------------------------------------|-------------------------------------|
| <input checked="" type="checkbox"/> | <input checked="" type="checkbox"/> | <input checked="" type="checkbox"/> | <input checked="" type="checkbox"/> | <input checked="" type="checkbox"/> | <input checked="" type="checkbox"/> |
| bath environments | terraces | new building work | cardboard plaster | ceramic showers | pools |

imperbox

Features:

- Water-based paste.
- Indoor waterproofer.
- Excellent adherence. Flexible.
- Good chemical resistance.
- Quick and easy application.

Recommended use:

- Private bathrooms. Built in showers.
- Public toilets and showers.
- Spas and premises in permanently damp environments.
- Balconies, covered terraces, cornices and gutters.
- Adhesion promoter on old vinyl and polyurethane adhesives.
- Do not use in outdoors surfaces greater than 10 m².

Coverage:

Bond coat		
• One-layer application.		1,8 kg/m ²
Waterproofing		
• Two-layer application.		3,6 kg/m ²
Mean thickness per imperbox layer: 1.5 mm		

Materials:

- Absorbent and non-absorbent ceramic tiles. Porcelain tiles with a water absorption < 0.5% as per EN-ISO 10545-3.
- Glass mosaic.
- Natural stone and marble not prone to staining.

Angles and waterproof bands:

Special pieces made of waterproof thermoplastic rubber, mounted on polyester sheets which allow laying with type C2 cement-based adhesives as per EN 12004. Specially designed for waterproofing critical spots.

1. **Inner angle:** Piece for sealing inner corners.
2. **Outer angle:** Piece for sealing outer corners.
3. **Waterproof band:** 8 cm wide waterproofing band for sealing edges, level changes and movement joints.

Substrates:

- Cement covered floors and walls .
- Anhydrite or plaster covered floors and walls .
- Concrete slabs.
- Plasterboards.
- Plywood boards.

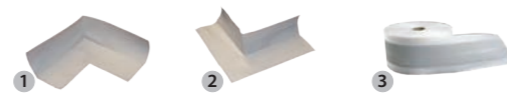

imperbox

KEA	SAP		P/EU
B84906005	100006223	imperbox manhattan	6,31 p/kg
B84900101	100006210	outer angle	7,80 p/u
B84900202	100006211	inner angle	7,80 p/u
B85900008	100081532	5 ml waterproof band	4,24 p/ml
B85900009	100081531	10 ml waterproof band	4,05 p/ml
B84905004	100006221	50 ml waterproof band	3,90 p/ml

Packaging

Presentation	Europallet
10 kg can	450 kg/pallet
Unit	
Unit	
5 m roll	
10 m roll	
50 m roll	



imperband

imperband is a waterproof sheet, specially designed for indoor waterproofing of ceramic wall and floor coverings.

It is a 0,5mm thick polymer membrane with a double thermoplastic polyolefin sheet and covered on both sides by non woven polyester fibers that allow it to be bonded to surfaces using cement-based adhesives. Ideal for use in new construction and refurbishment of showers and baths, and any indoor environment permanently affected by damp.



- bath environments
- terraces
- new building work
- refurbishing bathrooms
- ceramic showers
- pools

imperband

Features:

- Double thermoplastic polyolefin membrane covered on both sides by non woven polyester fibers.
- Maximum waterproofing with minimal thickness (0.5 mm).
- Direct installation of the tile on the sheet.
- Good chemical resistance.
- Quick and easy application.

Installation:

- **imperband** sheet is compatible with type C2 cement-based adhesive as per EN 12004.
- In case of surfaces bigger than the length of the sheet, overlap two 10 cm sheets and bond with C2 adhesive.
- In waterproofing of floors, leave an excess of sheet of at least 10 cm in all the spots where floor meets the wall.
- Be extremely cautious when connecting the sheet to the drainage systems.
- Once the **imperband** sheet has been installed, cover with the chosen floor covering. Never leave exposed to direct sunlight.

Certifications/Standards:

Avis technique: CSTB 13/08-1035

imperband

KEA	SAP		P/EU
B84901001	100006213	imperband	13,33 p/m ²
B84901006	100006218	imperband	13,83 p/m ²

Recommended use:

- Private bathrooms. Built in showers.
- Public toilets and showers.
- Spas and premises in permanently damp environments.
- Balconies and terraces smaller than 10 m².
- Do not use in outdoors surfaces greater than 10 m².

Materials:

- Absorbent and non-absorbent ceramic tiles. Porcelain tiles with a water absorption < 0.5% as per EN-ISO 10545-3.
- Glass mosaic.
- Natural stone and marble not prone to staining.

Substrates:

- Cement covered floors and walls .
- Concrete slabs.
- Plasterboards.
- On anhydrite or plaster substrates apply **uniprim**.

Packaging

Presentation	Europallet
30 m roll	720 m/pallet
5 m roll	300 m/pallet

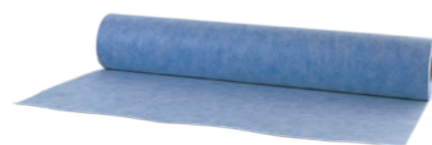

bathroom drain

The **bathroom drain** from **butech** is a drain for built in shower trays. It features a wide dish around the grating, which ease the connection to the **imperband** waterproofing sheet. Available with horizontal and vertical outlet, it helps to solve easily and effectively indoor waterproofing and drainage.

The 10 cm connecting piece between the grating and the drain can be cut, so that it can be installed with glass mosaics up to natural stones. Includes steel grating.



- indoor
- outdoor
- new building work
- refurbishing bathrooms
- ceramic showers
- Concept XPS shower tray.

bath drain

Recommended use:

- Drain designed for connecting with **imperband** waterproofing sheet.
- Specially designed for waterproofing built in showers.
- Available with horizontal or vertical outlet

Features for horizontal bathroom drain:

- 75 mm high drain.
- Discharge speed. 0.6 l/s.
- 50 mm horizontal outlet.
- 22 cm diameter crown for imperband fixation.
- Optional outlet for serial connections.
- Includes u-bend.
- 10 x 10 cm steel grating.



Features for vertical bathroom drain:

- 140 mm high drain.
- Discharge speed. 0.9 l/s.
- 50 mm vertical outlet.
- 26.5 cm diameter crown for imperband fixation.
- Includes u-bend.
- 10 x 10 cm steel grating.



bath drain

KEA	SAP		P/EU
B82901001	100005822	40/50 horizontal drain	27,64 p/u
B82901002	100005823	50 vertical drain	34,16 p/u
B82901003	100005824	compensation piece	38,62 p/u
B82901004	100005825	bathroom drain connection	16,20 p/u
B82901005	100005826	round grating	54,63 p/u

Bath drain complements

Bathroom drain connection:

Clamp for fixing imperband sheet to drain. Includes stainless steel clamp, rubber o-ring and 6 fixing screws.



Compensation piece:

Connection piece between drain and grating for installations with two overlaid waterproofing levels. 30.5 cm diameter crown for imperband fixation. 12.5 cm high piece.



Round grating:

Chromed plastic grating with a 10 x 10 cm round design. Includes chromed frame.



Packaging

Presentation
1 u./box
1 u./box
1 u./box
1 u./box

imperband standard kit

The **standard imperband kit** is an indoor waterproofing system consisting of a PVC gutter thermowelded to a 150 x 225 cm waterproof sheet. Specially recommended for waterproofing shower trays in new building works. Residential use.

The waterproof sheet is an imperband type 0,5 mm thick polymer membrane with a double thermoplastic polyolefin sheet and covered on both sides by non woven polyester fibers that allow it to be bonded to surfaces using cement-based adhesives. The gutter features a compact design and multiple possibilities of outlet connections.



imperband standard kit

Features:

- Maximum security, it eliminates leakage risks between waterproof sheet and drain piece.
- 150 x 225 cm waterproof sheet.
- Discharge speed. 0.6 l/s.
- Compact system, just 100 mm high.
- Adaptable to horizontal and vertical outlets. Adjustable outlet diameter: 40/50 mm.
- Includes u-bend.
- Direct installation of the tile on the waterproof sheet.
- Quick and easy application.

Installation:

- Depending on the drainage pipe position, select one of the system outlets and seal the other outlet with the cap provided to that effect.
- Given the case, use the drain outlet diameter adapter and glue the drainage pipe.
- Before laying the ceramics of the shower tray, check that the gutter works correctly.
- Use the waterproof sheet in the same way as the **imperband** sheet.

Recommended use:

- Specially designed for waterproofing built in showers.

Materials:

- Absorbent and non-absorbent ceramic tiles. Porcelain tiles with a water absorption < 0.5% as per EN-ISO 10545-3.
- Glass mosaic.
- Natural stone.

Substrates:

- Cement covered floors.
- Specially designed for **Concept XPS** shower trays, prefabricated polystyrene panels.

Packaging

Presentation
1 kit/box



imperband kit

KEA	SAP		P/EU
B82902038	100103360	1.5 x 2.25 m standard	78,2 p/u

Before using this product in any application not indicated in this catalogue, please perform a test or refer to the product's technical sheet.

imperband refurbishing kit

The **imperband refurbishing kit** is an indoor waterproofing system consisting of an extrathin PVC gutter thermowelded to a 150 x 225 cm waterproof sheet. Specially recommended for waterproofing shower trays in refurbishing jobs. Residential use.

The waterproof sheet is an **imperband** type 0.5 mm thick polymer membrane with a double thermoplastic polyolefin sheet and covered on both sides by non woven polyester fibers that allow it to be bonded to surfaces using cement-based adhesives. The only 65 mm drain height allows to carry out installations of 75 mm from the substrate to the ceramic wall covering.

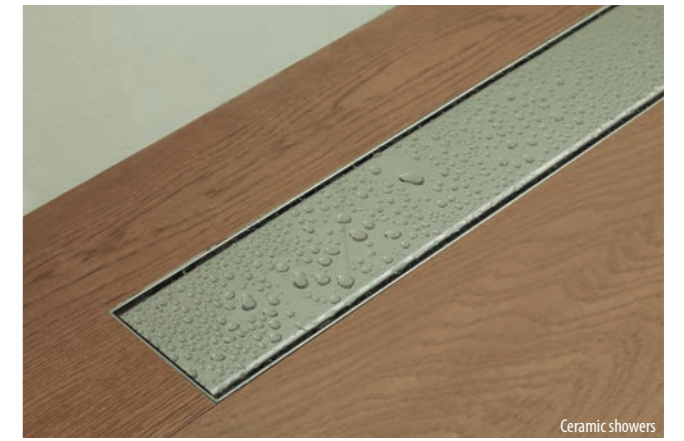

imperband refurbishing kit

Features:

- Maximum security, it eliminates leakage risks between waterproof sheet and drain piece.
- 150 x 225 cm waterproof sheet.
- Discharge speed. 0.5 l/s.
- Very compact system, just 75 mm high.
- 50 mm diameter horizontal outlet.
- Includes u-bend.
- Direct installation of the tile on the waterproof sheet.
- Quick and easy application.

Installation:

- Connect the **imperband refurbishing kit** and check that the gutter works correctly.
- Use the waterproof sheet in the same way as the **imperband** sheet.

Recommended use:

- Specially designed for waterproofing showers in refurbishing jobs.

Materials:

- Absorbent and non-absorbent ceramic tiles. Porcelain tiles with a water absorption < 0.5% as per EN-ISO 10545-3.
- Glass mosaic.
- Natural stone.

Substrates:

- Cement covered floors.
- Specially designed for **Concept XPS** shower trays, prefabricated polystyrene panels.

Packaging

Presentation
1 kit/box



Before using this product in any application not indicated in this catalogue, please perform a test or refer to the product's technical sheet.

linear grids

gold

KEA	SAP		P/EU
B82902072	100130481	59,6 x 9,3 cm	467,25 p/u
B82902073	100130482	80 x 9,3 cm	619,50 p/u

Packaging

Presentation
1 grating/box
1 grating/box

glass grey

KEA	SAP		P/EU
B82902089	100144635	59,6 x 9,3 cm	322,33 p/u

Packaging

Presentation
1 grating/box

glass beige

KEA	SAP		P/EU
B82902085	100144633	59,6 x 9,3 cm	322,33 p/u

Packaging

Presentation
1 grating/box

glass white

KEA	SAP		P/EU
B82902078	100141155	120 x 9,3 cm	630,00 p/u
B82902079	100141156	59,6 x 9,3 cm	322,33 p/u
B82902081	100141157	80 x 9,3 cm	417,87 p/u

Packaging

Presentation
1 grating/box
1 grating/box
1 grating/box

glass black

KEA	SAP		P/EU
B82902077	100141152	120 x 9,3 cm	630,00 p/u
B82902076	100141153	59,6 x 9,3 cm	322,33 p/u
B82902080	100141154	80 x 9,3 cm	417,87 p/u

Packaging

Presentation
1 grating/box
1 grating/box
1 grating/box

ceramic

KEA	SAP		P/EU
B82902168	100119619	120 x 9,3 cm	504,90 p/u
B82902090	100119620	59,6 x 9,3 cm	279,48 p/u
B82902153	100119621	80 x 9,3 cm	372,30 p/u

Packaging

Presentation
1 grating/box
1 grating/box
1 grating/box

white

KEA	SAP		P/EU
B82902066	100120375	120 x 9,3 cm	490,35 p/u
B82902067	100120376	59,6 x 9,3 cm	245,70 p/u
B82902065	100120377	80 x 9,3 cm	326,55 p/u

Packaging

Presentation
1 grating/box
1 grating/box
1 grating/box

chrome texture

KEA	SAP		P/EU
B82902044	100103364	120 x 9,3 cm	449,75 p/u
B82902045	100103365	59,6 x 9,3 cm	240,09 p/u
B82902042	100103366	80 x 9,3 cm	323,32 p/u

Packaging

Presentation
1 grating/box
1 grating/box
1 grating/box

texture

KEA	SAP		P/EU
B82902047	100103367	120 x 9,3 cm	431,79 p/u
B82902036	100103368	59,6 x 9,3 cm	228,80 p/u
B82902048	100103369	80 x 9,3 cm	311,96 p/u

Packaging

Presentation
1 grating/box
1 grating/box
1 grating/box

squared

KEA	SAP		P/EU
B82902035	100103370	120 x 9,3 cm	434,28 p/u
B82902041	100103371	59,6 x 9,3 cm	234,69 p/u
B82902039	100103372	80 x 9,3 cm	317,80 p/u

Packaging

Presentation
1 grating/box
1 grating/box
1 grating/box

line

KEA	SAP		P/EU
B82902043	100103373	120 x 9,3 cm	434,28 p/u
B82902046	100103374	59,6 x 9,3 cm	234,69 p/u
B82902040	100103375	80 x 9,3 cm	317,80 p/u

Packaging

Presentation
1 grating/box
1 grating/box
1 grating/box

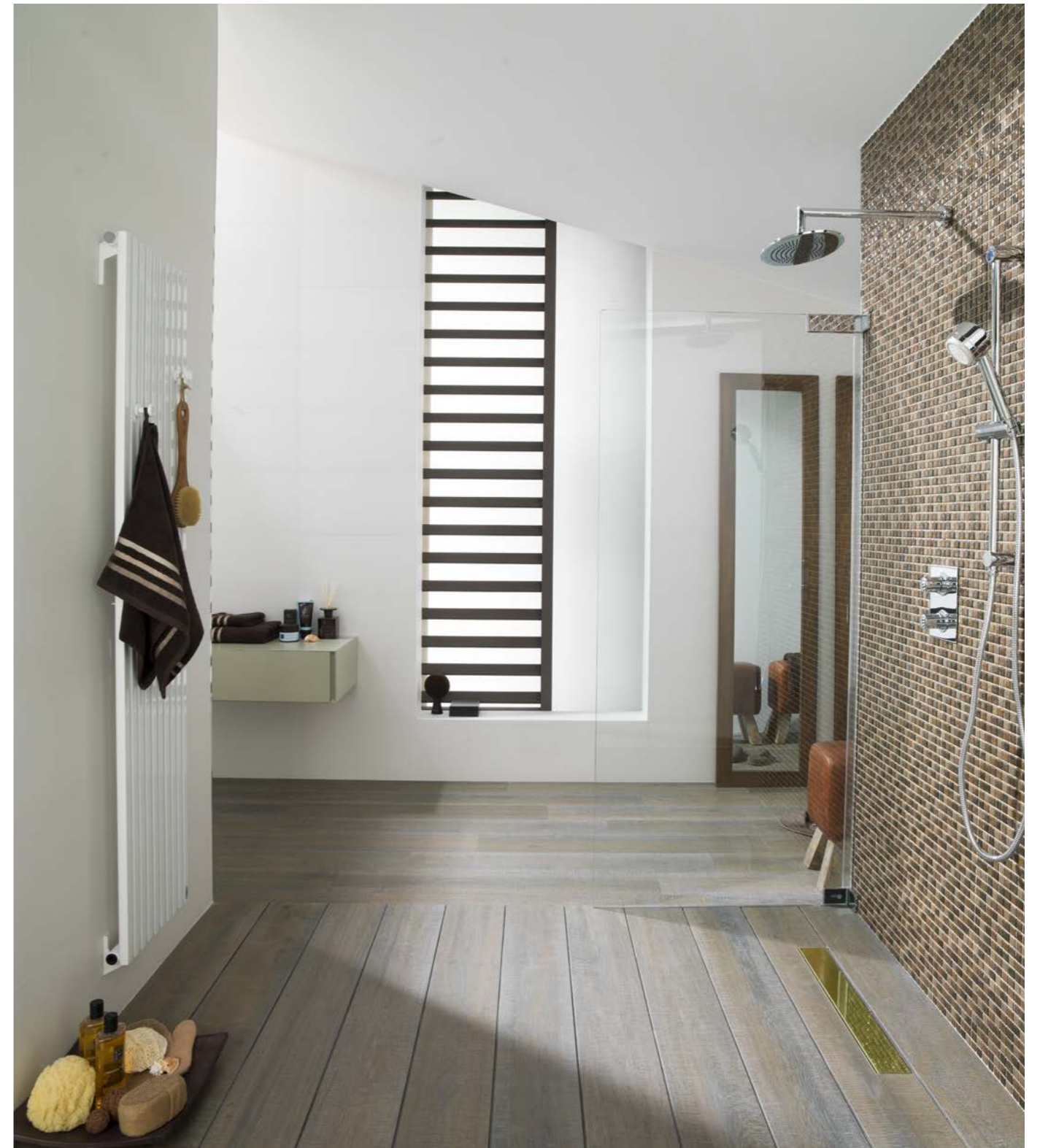

square grids

standard

KEA	SAP		P/EU
B82902094	100148572	squared usa	34,65 p/u
B82902021	100089372	squared	23,02 p/u
B82902056	100114593	sun	44,84 p/u

Packaging

Presentation
1 grating/box
1 grating/box
1 grating/box



standard USA squared sun

sylastic

sylastic is a two-component cement-based waterproofer with excellent bonding and deformability features, specially recommended for waterproofing outdoors. Compatible with type C2 cement-based adhesive as per EN 12004. Indoor and outdoor use.

Prevents the need of screed between waterproofing sheet and ceramic floor, thus reducing the final system thickness. It is applied in two 1-2 mm layers each, with a fiberglass mesh reinforcement on the first application. Special pieces and bands available for waterproofing joints and other critical spots.



- bath environments
- terraces
- new building work
- refurbishing bathrooms
- ceramic showers
- pools

sylastic

Features:

- Two-component waterproofing mortar.
- Indoor and outdoor waterproofer.
- Maximum waterproofing with minimal thickness (3 mm).
- It allows for direct laying of ceramic tiles with cement-based adhesive.
- Excellent adherence and maximum deformability.
- Good chemical resistance.
- Suitable for direct contact with water.

Recommended use:

- Waterproofing of bathrooms and showers.
- Spas and premises in permanently damp environments.
- Outdoor terraces and balconies.
- Pools and premises into direct contact with water.
- Cisterns and reservoirs into direct contact with water.
- Repair of cracked floors and renderings.
- Promotes adherence on existing ceramic wall tiles and on wood or metal substrates.

Coverage:

Bond coat:	
• One-layer application.	
• Sylastic mortar	1,95 Kg / m ²
• Sylastic additive	0,65 Kg / m ²
Waterproofing:	
• Two-layer application.	
• Sylastic mortar	3,90 Kg / m ²
• Sylastic additive	1,30 Kg / m ²
Mean thickness per sylastic layer: 1.5 mm	

Materials:

- Absorbent and non-absorbent ceramic tiles. Porcelain tiles with a water absorption < 0.5% as per EN-ISO 10545-3.
- Glass mosaic.
- Natural stone and marble not prone to staining.

Substrates:

- Cement covered floors and walls .
- Concrete slabs.
- Plasterboards.
- Wood boards.
- Existing floor tiles.
- Metal sheets.

Packaging

Presentation	Europallet
24 kg bag	960 kg/pallet
8 kg can	320 kg/pallet
50 m ² reel	
5 m roll	
10 m roll	
50 m roll	
Unit	
Unit	



sylastic

KEA	SAP		P/EU
B85900004	100072729	sylastic mortar	0,83 p/kg
B85900005	100072730	sylastic additive	10,40 p/kg
B84900303	100006212	50 m fiberglass mesh	2,81 p/m ²
B85900008	100081532	5 m waterproof band	4,24 p/ml
B85900009	100081531	10 m waterproof band	4,05 p/ml
B84905004	100006221	50 m waterproof band	3,90 p/ml
B84900101	100006210	outer angle	7,80 p/u
B84900202	100006211	inner angle	7,80 p/u

Before using this product in any application not indicated in this catalogue, please perform a test or refer to the product's technical sheet.

terrace drain

The **floor drain** from **butech** is a drain for terraces and outdoor floors. It features a wide dish around the grating, which ease the connection to waterproofing sheets. Available with horizontal and vertical outlet, it helps to solve easily and effectively outdoor waterproofing and drainage.

The 10 cm connecting piece between the grating and the drain can be cut, so that it can be installed with glass mosaics up to natural stones. Includes steel grating.



- indoor
- outdoor
- lamitech n
- sylastic
- new building work
- concept xps shower tray.

terrace drain

Recommended use:

- Drain designed for connecting with waterproofing sheet.
- Specially designed for waterproofing outdoor terraces and floors.
- Vertical outlet.

Terrace drain features:

- 190 mm high drain.
- Discharge speed. 1.6 l/s.
- 75/110 mm vertical outlet.
- 36 cm diameter crown for waterproofing sheet fixation.
- Includes u-bend.
- 143 x 143 mm steel grating.



Terrace drain complements

Terrace drain connection:

Clamp for fixing waterproofing sheet to drain. Includes stainless steel clamp, rubber o-ring and 6 fixing screws.



Compensation piece:

Connection piece between drain and grating for installations with two overlaid waterproofing levels. 36 cm diameter crown for waterproofing sheet fixation. 12.5 cm high piece.

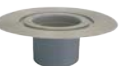

Terrace drain

KEA	SAP		P/EU
B82901009	100005827	75/110 vertical drain	60,97 p/u
B82901010	100005828	compensation piece	41,46 p/u
B82901011	100005829	floor drain connection	27,42 p/u

Packaging

Presentation
1 u./box
1 u./box
1 u./box

Before using this product in any application not indicated in this catalogue, please perform a test or refer to the product's technical sheet.

lamitech n

lamitech n is a multilayer polymer sheet, specially designed for outdoor floors decoupling. Protects tiles against substrate tensions, reducing the risk of breakage and piece lifting. Suitable for outdoor waterproofing.

Coextruded HDPE/EVAC membrane, with one side covered with polyester fibers and the other one with polyester entwined felt, that allows laying with cement-based adhesives. Absorbs tensions, reducing their transmission to the ceramic floor. Indoor and outdoor use.



- bath environments
- terraces
- anti-cracks
- refurbishing
- ceramic showers
- pools

lamitech n

Features:

- Multilayer HDPE/EVAC polymer membrane covered with polyester fibers.
- Maximum outdoors waterproofing with minimal thickness (3,4 mm).
- It allows for direct laying of ceramic tiles with cement-based adhesive.
- Good chemical resistance.
- Improves impact noise reduction.
- Quick and easy application.

Recommended use:

- Decoupling of balconies and terraces.
- Waterproofing of outdoor floors.
- Laying of ceramics on wood substrates.
- Laying of floor tiles on cracked substrates. Terrace refurbishing.
- Laying of ceramics on substrates which are not set yet or present residual damp.

Installation:

- lamitech n sheet is compatible with type C2 cement-based adhesive as per EN 12004.
- Place sheets side by side, without overlappings. In case of using it as water-proofer, proceed to sealing sheet joints with **sylastic** waterproof mortar and **lamiband 200** waterproof band..
- In waterproofing of floors, lengthen the waterproofing with **lami-band 200** at least 10 cm in all the spots where floor meets the wall.
- In movement joints, use flexible tape **waterproof band**.
- Be extremely cautious when connecting the sheet to the drainage systems.
- Once lamitech n has been installed, lay the chosen floor with compatible adhesives. Never leave exposed to direct sunlight.

Materials:

- Absorbent and non-absorbent ceramic tiles. Porcelain tiles with a water absorption < 0.5% as per EN-ISO 10545-3.
- Glass mosaic.
- Natural stone and marble not prone to staining.

Substrates:

- Cement or anhydrite covered floors.
- Concrete slabs.
- Existing floor tiles.
- Plywood boards.

Packaging

Presentation	Europallet
5 m reel	200 m ² /pallet

30 m reel
50 m roll

24 kg bag
8 kg can

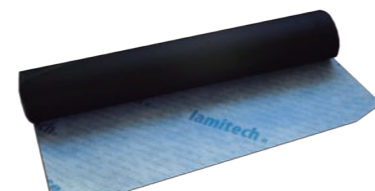

lamitech n

KEA	SAP		P/EU
B85900011	100089879	lamitech n	13,92 p/m ²
B84901005	100006217	200 mm lami-band	3,85 p/m
B84905004	100006221	waterproof band	3,90 p/m ²
B85900004	100072729	sylastic mortero	0,83 p/kg
B85900005	100072730	sylastic aditivo	10,40 p/kg

Before using this product in any application not indicated in this catalogue, please perform a test or refer to the product's technical sheet.

super drain

super-drain is an 8 mm thick drainage sheet for waterproofing systems in outdoor terraces and balconies. It eases water evacuation and reduces the risk of damp appearance. Suitable for floors as well as for walls.

Polyethylene sheet with a tridimensional structure. It features 20 mm diameter circular nerves and it is covered by a filtering fabric. Installed on the waterproofing system, it drains the water towards the drain and protects mechanically.



- bath environments
- terraces
- new building work
- refurbishing terraces
- drainage
- pools

super-drain

Features:

- Polyethylene sheet with tridimensional structure with 20 mm circles.
- Maximum drainage with a 5 mm thickness.
- Good chemical resistance.
- Quick and easy application.

Recommended use:

- Outdoor floors drainage. Terraces and balconies.
- Protection of ceramic floors against efflorescences.
- Reduction of the risk of substrate cracking.
- Protection of walls against damp.

Installation:

- super-drain sheet is directly installed on the waterproofing system with the filtering side facing up.
- In the case of surfaces bigger than 100 cm, overlap two super-drain sheets fitting at least three gap lines.
- Once the super-drain sheet laid, cover with a mortar at least 4 cm thick and leave the surface ready for laying tiles with the thin-bed method.

Materials:

- Absorbent and non-absorbent ceramic tiles. Porcelain tiles with a water absorption < 0.5% as per EN-ISO 10545-3.
- Glass mosaic.
- Natural stone and marble not prone to staining.

Substrates:

- Waterproofing sheets and paints.
- Slopes are needed on the waterproofing substrate.

super-drain

KEA	SAP		P/EU
B84901004	100006216	super-drain	11,97 p/m ²

Packaging

Presentation	Europallet
15 m ² reel	135 m ² /pallet

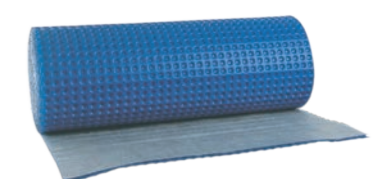

Before using this product in any application not indicated in this catalogue, please perform a test or refer to the product's technical sheet.



concept systems

concept xps panels

concept xps panels	151
Fixing elements for concept xps panels	152
Technical features	158
General instructions for installation	158

concept xps shower trays

concept xps shower trays	159
Standard shower trays	161
Refurbishing shower trays	163
Custom shower trays	165
Bespoke standard shower trays	167
Bespoke refurbishing shower trays	169

concept xps showers

Altea concept shower	172
Victoria corner concept shower	172
Niágara concept shower	173
concept benches	173
Iguazú concept cabin	174

concept xps panel

concept xps panels are extruded polystyrene panels ready for laying wall tiles, mosaics or natural stone with cement-based adhesives. Polystyrene lightness and easy handling, as well as its mechanical resistance and damp resistance make of this panel the perfect substrate for all kinds of environments where damp is present.

This kind of panel is available in thicknesses ranging from 4 to 80 mm and also in special precut boards that allow for a fast installation of curved shapes.

Features:

- Extruded polystyrene boards covered on both sides with waterproof cement mortar.
- Non-absorbent material. Its structure prevents water buildup. Resistant to dampness.
- Excellent surface for laying rectified tiles.
- Low thermal conductivity coefficient.
- Good soundproofing against impact noise.
- Easy handling and transport.
- Quick and clean installation.
- Resistant to microorganism attack.
- Inert and non-hazardous material made with 50% to 70% recycled material.
- Fire resistant: B1 as per DIN 4102.

Substrates:

- Usual indoor substrates in the building industry.
- Uncovered brick partition walls.
- Concrete floor slabs.
- Existing wall and floor tiles.
- Self-supporting indoors. Only 50 and 80 mm boards.

concept xps panels

KEA	SAP		P/EU
B88000286	100103351	4 mm 1250 x 600	19,70 p/u
B88000287	100103352	6 mm 1250 x 600	19,70 p/u
B88000289	100103349	10 mm 2500 x 600	44,13 p/u
B88000288	100103350	20 mm 2500 x 600	46,23 p/u
B88000292	100103354	30 mm 2500 x 600	47,63 p/u
B88000293	100103355	50 mm 2500 x 600	55,06 p/u
B88000291	100103356	80 mm 2500 x 600	86,09 p/u



Recommended uses:

- Preparation of substrates for ceramic tiles laying. Specially recommended in refurbishing jobs.
- Bathroom countertops and vanities in permanently wet areas.
- Bathroom partition walls and platforms.
- Bathtub skirts and shower cabins.
- Shelves and panels attached to partition walls.
- Health resorts, saunas and spa premises.
- Thermal insulation of electric radiant heating floors.

Materials:

- Absorbent and non-absorbent ceramic tiles. Porcelain tiles with a water absorption < 0.5% as per EN-ISO 10545-3.
- Glass mosaic.
- Natural stone and marble not prone to staining.

Packaging

u./pallet
150
150
120
100
68
40
24

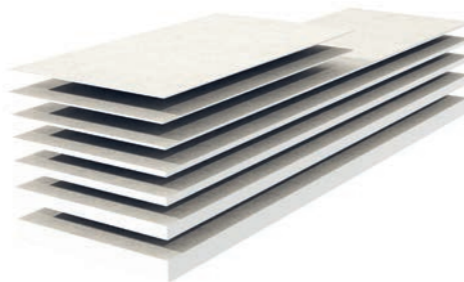

Fixing elements for concept xps panels

concept union

KEA	SAP	concept	P/EU
B88000002	100062797	50 mm U shape	14,78 p/u
B88000026	100062798	80 mm U shape	14,78 p/u
B88000029	100062791	50 mm H shape	29,69 p/u
B88000031	100062792	80 mm H shape	33,86 p/u
B88000003	100062795	50 mm T shape	26,47 p/u
B88000001	100062796	80 mm T shape	26,47 p/u
B88000030	100062793	50 mm L shape	26,47 p/u
B88000008	100062794	80 mm L shape	26,47 p/u

Packaging

Presentation
4 u. bag
4 u. bag
4 u. bag
4 u. bag
4 u. bag
4 u. bag
4 u. bag
4 u. bag



concept fastening

KEA	SAP		P/EU
B88000042	100067686	45 mm metal fastening	32,74 p/u
B88000017	100062773	130 mm plastic fastening	9,59 p/u
B88000028	100062774	130 mm plastic fastening	44,52 p/u
B88000021	100062775	80 mm plastic fastening	7,07 p/u
B88000013	100062776	80 mm plastic fastening	30,24 p/u
B88000014	100062790	concept bathtub skirt	26,14 p/u

Packaging

Presentation
50 u. bag
10 u. bag
50 u. bag
10 u. bag
50 u. bag
6 u. bag



Self-adhesive fiberglass mesh roll

KEA	SAP		P/EU
B88000012	100062825	self-adhesive fiberglass mesh	9,75 p/u
B88000009	100062826	self-adhesive fiberglass mesh	16,8 p/u

Packaging

Presentation
10 m roll
20 m roll



Polyurethane putty

KEA	SAP		P/EU
B82401003	100005820	P-404 black	6,32 p/ud

Packaging

Presentation
25 cartridges x box





Indoor partition walls.

concept xps 50 and concept xps 80 panels allow to create partition walls, partitions and, in general, any built in element in a bathroom. Using them reduces execution times and provides a perfect substrate for laying rectified ceramics or glass mosaic.

concept xps panels

KEA	SAP		P/EU
B88000293	100103355	2.500 x 600 x 50	55,06 p/u
B88000291	100103356	2.500 x 600 x 80	86,09 p/u

Refer to union and fastening elements on page 147.



Bathtub skirts.

concept xps 30 panels allow to create bathtub skirts in a fast and easy way. Specially recommended for whirlpool baths and in general for any kind of installation to which you need access once it has been installed.

There are adjustable height special pieces for the skirt base.

KEA	SAP		P/EU
B88000292	100103354	concept xps 30 panel 2.500 x 600 x 30	46,70 p/u

Refer to union and fastening elements on page 147.





Platforms and steps.

concept xps panels can replace, in bathrooms, any kind of building or wood work, reducing execution times and improving the final result. Specially recommended in projects with limitations for use overload.

concept xps panels

KEA	SAP		P/EU
B88000292	100103354	2.500 x 600 x 30	47,63 p/u
B88000293	100103355	2.500 x 600 x 50	55,06 p/u
B88000291	100103356	2.500 x 600 x 80	86,09 p/u

Refer to union and fastening elements on page 136.



Furniture and countertops.

concept xps panels can replace, in bathrooms, any kind of building or wood work, reducing execution times and improving the final result. Specially recommended in projects where the presence of water advises against the use of wood.

There are reinforcement elements for the installation of countertops and shelves.

concept xps panels

KEA	SAP		P/EU
B88000288	100103350	2.500 x 600 x 20	46,23 p/u
B88000292	100103354	2.500 x 600 x 30	47,63 p/u
B88000293	100103355	2.500 x 600 x 50	55,06 p/u
B88000291	100103356	2.500 x 600 x 80	86,09 p/u

Refer to union and fastening elements on page 136.





Wall and floor covering.

concept xps panels are an excellent solution for covering walls and floors prior to laying ceramics. Specially recommended in refurbishing jobs where, apart from preparing the substrate for laying ceramics, you need to waterproof and thermally isolate the substrate.

This kind of panel can be directly installed on the substrate with adhesive spots or installed on a plasterboard-type metallic structure.

concept xps panels

KEA	SAP		P/EU
B88000286	100103351	1.250 x 600 x 4	19,70 p/u
B88000287	100103352	1.250 x 600 x 6	19,70 p/u
B88000289	100103349	2.500 x 600 x 10	44,13 p/u
B88000288	100103350	2.500 x 600 x 20	46,23 p/u

Refer to union and fastening elements on page 136.



Technical features.

PROPERTIES	STANDARD	VALUE
Compression resistance (10% strain)	DIN 53421	300 KN/m ²
Nominal density	EN 1602	35 Kg/m ³
Shear resistance	EN 12090	0,25 N/mm ²
Tensile strength	EN 1607	0,50 N/mm ²
Adherence of the protection		> 2,0 Kg/cm ²
Resistance to eccentric load		> 10,0 Kg/cm ²
Water absorption		< 1,0 Kg/m ²
Thermal conductivity	EN 13164	0,034 W/m.k (30-60 mm) 0,036 W/m.k (> 60 mm)
Working temperature range		-50 °C / +75 °C
Tolerances		Length: +/- 5 mm
		Width: +/- 3 mm
		Thickness: +/- 2 mm
		Squareness: < 2 mm/m.l.
Fire resistance	DIN 4102-1	B s1-d0

General instructions for installation

- Measure accurately the surface to be covered and transfer the measures to the **concept xps** panel.
- Before installing the **concept xps** panel on the surface to be covered, clean and remove any element which could compromise the bonding.
- Depending on the panel thickness, cut with a cutter or a hand saw. Once cut, remove irregularities from the cut sides using a sanding paper.
- Use **super-one n**, type C2S1 FTE cement-based adhesive, to bond the **concept xps** panel on flat surfaces. On even surfaces, we recommend to use a notched trowel, while on uneven surfaces, the use of adhesive spots (5 spots/m²) is recommended.
- Use **concept 45 metal fasteners** (fixing screws) for installing panels on wooden substrates (5 fasteners/m²). Specially recommended on plywood substrates.
- Use **p-404**, polyurethane putty, for the union of panels, sealing of joints and bonding of panels.
- Use **plastic fasteners** (fixing screws) to reinforce cross union of panels. Specially recommended for corners.
- Use the self-adhesive fiberglass mesh to reinforce unions between boards and cover with a layer of **super-one n** adhesive. In the case you need to waterproof the joint, use **sylastic** waterproof mortar.
- In partition walls, use different kinds of **concept xps** unions to fix the boards to the substrate. We recommend the use of a U type union every 60 cm.
- In partition walls, we recommend to use an H type union every 100 cm to reinforce the union between adjacent boards.
- Use cut pieces from a **concept xps** panel to create structures and shapes to be covered with ceramics or mosaic. Specially recommended in platforms, steps, shelves and furniture in general.
- Once the **concept xps** installed, lay the chosen wall covering with **super-one n** adhesive and seal the joints with **colorstuk rapid**, type CG2 colored grout for joints. In Turkish baths and environments with high concentrations of water vapor, replace grout with **epotech aqua** epoxy putty.

concept xps shower trays

It is a prefabricated system for creating built in shower trays. They include the slopes for the correct water drainage, as well as the drain and the waterproofing system. This system is supplied ready to use, which reduces working times while guarantees a perfect substrate for laying mosaic, natural stone or ceramics.

concept xps shower tray is light, resistant and safe, reason why it is specially recommended in bathroom refurbishing jobs. It includes **imperband kit** as a drain and waterproofing system, but it does not include the decorative grating, so you can choose among a wide range of sizes, shapes and finishes.



Features:

- Prefabricated shower tray made of extruded polystyrene covered with cement mortar.
- It includes slopes for water drainage.
- Double waterproofing: covering consisting of waterproof mortar and imperband sheet.
- It includes **imperband kit** for waterproofing the shower tray and the adjustment piece.
- Available in two options:
 - **imperband standard kit:** 40 mm high
 - **imperband refurbishing kit:** 30 mm high
- Available for square as well as for linear drains.

- Compression resistance (10% crush risk): DIN 3421 0.3 N / mm²
- Initial thermal conductivity: DIN 2612 0.0336 W/m²K
- Flammability: DIN 4102 B1

concept shower tray selection guide

1. Depending on the drain outlet, select the type of **concept xps** shower tray to be used:

- Vertical outlet: **Standard tray**
- Horizontal outlet: Select depending on the shower tray height.

2. Depending on the shower tray height, select the type of **concept xps** tray to be used:

- 75–100 mm height **Refurbishing shower tray**
- > 100 mm height **Standard shower tray**

3. Select the type of decorative grating:

- Square grating: Shower tray for square grating
- Linear grating: Shower tray for linear grating

Recommended uses:

- Specially designed for waterproofing built in showers.

Materials:

- Absorbent and non-absorbent ceramic tiles. Porcelain tiles with a water absorption < 0.5% as per EN-ISO 10545-3.
- Glass mosaic.
- Natural stone and marble not prone to staining.

Substrates:

- Concrete floor slabs.
- Cement covered floors.

4. Select the grating position:

- ESQ: Grating on a corner.
- CENT: Grating in a central position.
- LAT: Grating in a lateral position.

5. Select the shower tray shape:

- Square shower tray.
- Rectangular shower tray.

6. Choose the shower tray among the available sizes.

In the case that the available sizes do not fit in the project needs, there is the possibility of making custom shower trays.



Standard shower trays for square grating

These shower trays feature a 40 mm thickness.
It includes the **imperband standard kit**.
Does not include the **square grating**.

concept xps shower trays

ESQ Corner grating

KEA	SAP	Square tray	P/EU
B88000240	100103276	900x900x40	289,45 p/u
B88000214	100103236	1000x1000x40	296,27 p/u
B88000210	100103249	1200x1200x40	322,01 p/u
B88000237	100103263	1500x1500x40	440,20 p/u

Packaging

Presentation
Shower tray + imperband kit
Shower tray + imperband kit
Shower tray + imperband kit
Shower tray + imperband kit

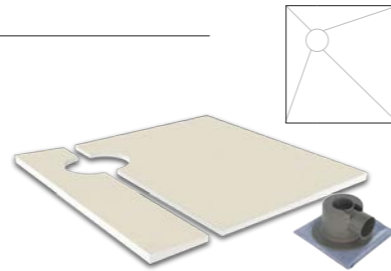

CENT Central grating

KEA	SAP	Square tray	P/EU
B88000230	100103275	900X900x40	289,97 p/u
B88000206	100103235	1000x1000x40	296,27 p/u
B88000236	100103248	1200x1200x40	322,01 p/u
B88000207	100103262	1500x1500x40	440,20 p/u

Packaging

Presentation
Shower tray + imperband kit
Shower tray + imperband kit
Shower tray + imperband kit
Shower tray + imperband kit

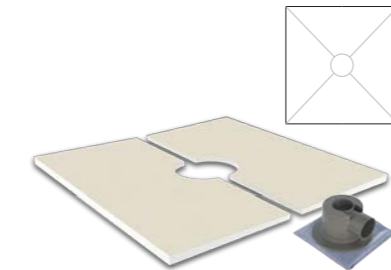

LAT Lateral grating

KEA	SAP	Rectangular shower tray	P/EU
B88000220	100103251	1200X900x40	298,27 p/u
B88000217	100103247	1200X1000x40	298,58 p/u
B88000234	100103257	1400X900x40	321,48 p/u
B88000204	100103265	1500X900x40	327,79 p/u
B88000227	100103264	1600X900x40	338,29 p/u
B88000307	100108080	1800X900X40	478,38 p/u

Packaging

Presentation
Shower tray + imperband kit
Shower tray + imperband kit
Shower tray + imperband kit
Shower tray + imperband kit
Shower tray + imperband kit
Shower tray + imperband kit

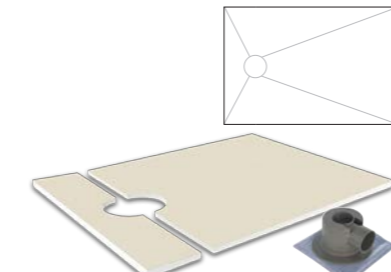

CENT Central grating

KEA	SAP	Rectangular shower tray	P/EU
B88000213	100103237	1000X800x40	282,61 p/u
B88000212	100103250	1200X900x40	298,37 p/u
B88000225	100103246	1200X1000x40	298,90 p/u
B88000216	100103256	1400X900x40	321,48 p/u
B88000239	100103264	1500X900x40	330,94 p/u
B88000218	100103266	1600X900x40	338,29 p/u
B88000232	100103270	1800X900X40	355,63 p/u

Packaging

Presentation
Shower tray + imperband kit
Shower tray + imperband kit
Shower tray + imperband kit
Shower tray + imperband kit
Shower tray + imperband kit
Shower tray + imperband kit

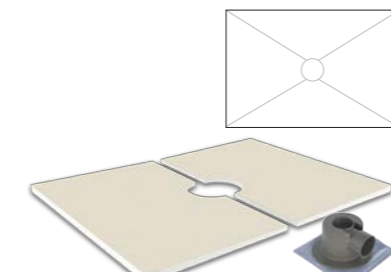

Square gratings

Square gratings

KEA	SAP	Square grating	P/EU
B82902094	100148572	squared usa	34,65 p/u
B82902021	100089372	squared	23,02 p/u
B82902056	100114593	sun	44,84 p/u

Packaging

Presentation
1 grating/box
1 grating/box
1 grating/box



Standard shower trays for linear grating

These shower trays feature a 40 mm thickness.
It includes the **imperband standard kit**.
Does not include **linear gratings**.

concept xps shower trays

LINEAR LAT Q Linear grating

KEA	SAP	Square tray	P/EU
B88000296	100105151	900X900x40	622,20 p/u
B88000376	100114468	1000x1000x40	632,40 p/u
B88000299	100106439	1200x1200x40	828,24 p/u
B88000370	100114485	1500x1500x40	969,00 p/u

Packaging

Presentation
Shower tray + imperband kit
Shower tray + imperband kit
Shower tray + imperband kit
Shower tray + imperband kit

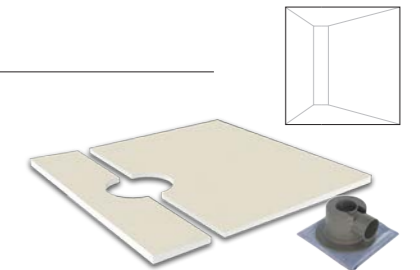

LINEAR CENT Q Linear grating

KEA	SAP	Square tray	P/EU
B88000369	100114496	900X900x40	622,20 p/u
B88000363	100114467	1000x1000x40	632,40 p/u
B88000365	100114477	1200x1200x40	828,24 p/u
B88000366	100114484	1500x1500x40	969,00 p/u

Packaging

Presentation
Shower tray + imperband kit
Shower tray + imperband kit
Shower tray + imperband kit
Shower tray + imperband kit

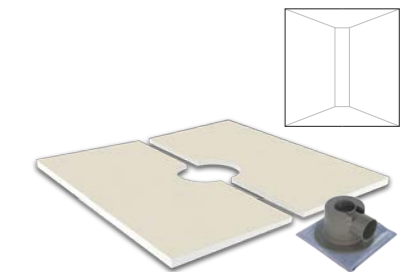

LINEAR LAT R Lateral grating

KEA	SAP	Rectangular shower tray	P/EU
B88000303	100106437	1000X900x40	622,20 p/u
B88000295	100105150	1200X900x40	632,40 p/u
B88000304	100106438	1200X1000x40	637,50 p/u
B88000302	100106440	1400X900x40	652,80 p/u
B88000300	100106441	1500X900x40	688,50 p/u
B88000374	100114491	1600X900x40	703,80 p/u
B88000319	100108880	1800X900X40	724,20 p/u

Packaging

Presentation
Shower tray + imperband kit
Shower tray + imperband kit
Shower tray + imperband kit
Shower tray + imperband kit
Shower tray + imperband kit
Shower tray + imperband kit

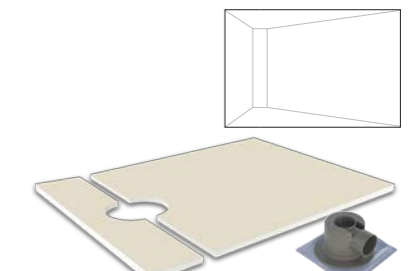

LINEAR CENT R Central grating

KEA	SAP	Rectangular shower tray	P/EU
B88000387	100114470	1000X800x40	612,00 p/u
B88000388	100114479	1200X900x40	632,40 p/u
B88000373	100114474	1200X1000x40	637,50 p/u
B88000381	100114482	1400X900x40	652,80 p/u
B88000393	100114488	1500X900x40	688,50 p/u
B88000371	100114490	1600X900x40	703,80 p/u
B88000385	100114493	1800X900X40	724,20 p/u

Packaging

Presentation
Shower tray + imperband kit
Shower tray + imperband kit
Shower tray + imperband kit
Shower tray + imperband kit
Shower tray + imperband kit
Shower tray + imperband kit

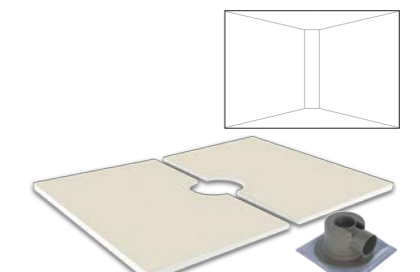

Linear gratings

Information referring to linear gratings is on page 143.

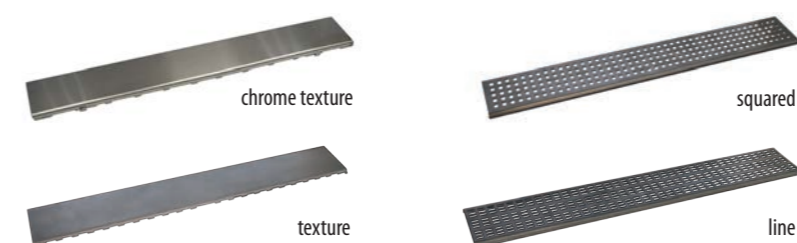

Select the linear grid depending on the shower tray width, so that the minimum distance between the grid and the concept xps shower tray sides exceeds 100 mm on both sides. We recommend to follow the instructions given in the table below:

Grid length:	Shower tray width:
59.6 x 9.3 cm	> 800 mm
80 x 9.3 cm	> 1000 mm
120 x 9.3 cm	> 1400 mm

The shower tray width corresponds to the second digit of the columns corresponding to Rectangular Shower Tray and Square Shower Tray.

Refurbishing shower trays for square grating

These shower trays feature a 30 mm thickness.
It includes the **imperband refurbishing kit**.
Does not include the **square grating**.

concept xps shower trays

ESQ Corner grating

KEA	SAP	Square tray	P/EU
B88000260	100103297	900X900x30	308,88 p/u
B88000249	100103282	1000X1000x30	316,23 p/u
B88000256	100103295	1200X1200x30	341,45 p/u
B88000285	100103312	1500X1500x30	460,16 p/u

Packaging

Presentation
Shower tray + imperband kit
Shower tray + imperband kit
Shower tray + imperband kit
Shower tray + imperband kit

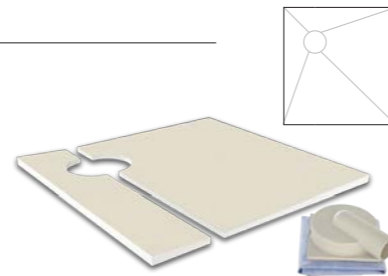

CENT Central grating

KEA	SAP	Square tray	P/EU
B88000257	100103296	900X900x30	308,88 p/u
B88000247	100103281	1000X1000x30	316,23 p/u
B88000252	100103294	1200X1200x30	341,45 p/u
B88000271	100103311	1500X1500x30	460,16 p/u

Packaging

Presentation
Shower tray + imperband kit
Shower tray + imperband kit
Shower tray + imperband kit
Shower tray + imperband kit

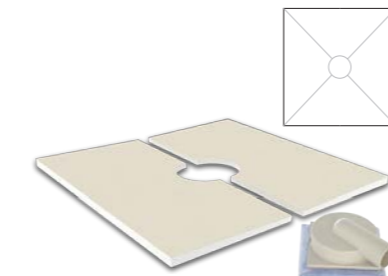

LAT Lateral grating

KEA	SAP	Rectangular shower tray	P/EU
B88000262	100103300	1200X900x30	317,81 p/u
B88000259	100103293	1200X1000x30	318,33 p/u
B88000264	100103306	1400X900x30	340,39 p/u
B88000279	100103314	1500X900x30	346,70 p/u
B88000282	100103316	1600X900x30	358,25 p/u

Packaging

Presentation
Shower tray + imperband kit
Shower tray + imperband kit
Shower tray + imperband kit
Shower tray + imperband kit
Shower tray + imperband kit

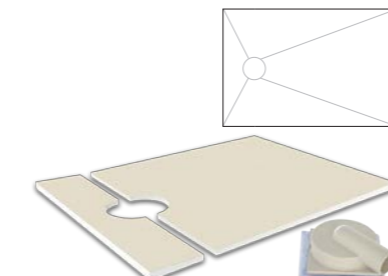

CENT Central grating

KEA	SAP	Rectangular shower tray	P/EU
B88000253	100103283	1000X800x30	301,52 p/u
B88000261	100103299	1200X900x30	317,81 p/u
B88000248	100103292	1200X1000x30	318,33 p/u
B88000277	100103305	1400X900x30	340,39 p/u
B88000283	100103313	1500X900x30	346,70 p/u
B88000272	100103315	1600X900x30	358,25 p/u
B88000269	100103319	1800X900x30	375,06 p/u

Packaging

Presentation
Shower tray + imperband kit
Shower tray + imperband kit
Shower tray + imperband kit
Shower tray + imperband kit
Shower tray + imperband kit
Shower tray + imperband kit

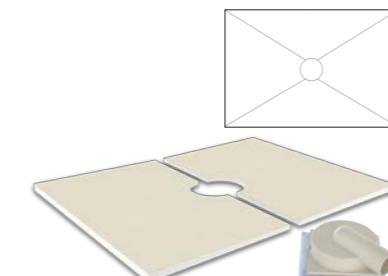

All the **concept xps** shower trays have available a 50 mm thickness special piece to increase the height of the shower tray and cover sewer and drain. Check conditions with your sales representative from PORCELANOSA GRUPO.

Refurbishing shower trays for linear grating

These shower trays feature a 30 mm thickness.
It includes the **imperband refurbishing kit**.
Does not include **linear gratings**.

concept xps shower trays

LINEAR LAT Q Linear grating

KEA	SAP	Square tray	P/EU
B88000367	100114495	900X900x30	622,20 p/u
B88000380	100114466	1000X1000x30	632,40 p/u
B88000378	100114476	1200X1200x30	828,24 p/u
B88000439	100116128	1500X1500x30	969,00 p/u

Packaging

Presentation
Shower tray + imperband kit
Shower tray + imperband kit
Shower tray + imperband kit
Shower tray + imperband kit

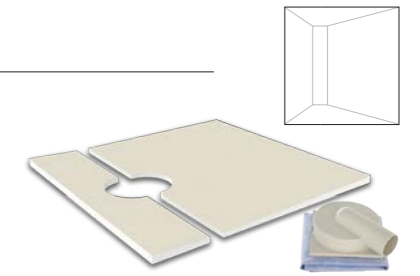

LINEAR CENT Q Linear grating

KEA	SAP	Square tray	P/EU
B88000390	100114494	900X900x30	622,20 p/u
B88000362	100114465	1000X1000x30	632,40 p/u
B88000383	100114475	1200X1200x30	828,24 p/u
B88000392	100114483	1500X1500x30	969,00 p/u

Packaging

Presentation
Shower tray + imperband kit
Shower tray + imperband kit
Shower tray + imperband kit
Shower tray + imperband kit

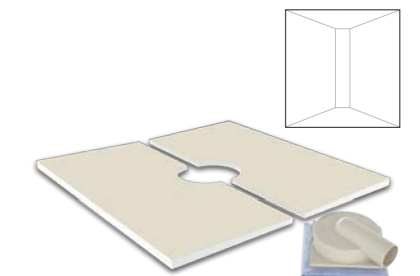

LINEAR LAT R Lateral grating

KEA	SAP	Rectangular shower tray	P/EU
B88000379	100114471	1000X900x30	622,2 p/u
B88000354	100111299	1200X900x30	632,4 p/u
B88000368	100114473	1200X1000x30	637,5 p/u
B88000384	100114481	1400X900x30	652,8 p/u
B88000375	100114487	1500X900x30	688,5 p/u
B88000361	100114464	1600X900x30	703,8 p/u
B88000349	100110584	1800X900x30	724,2 p/u

Packaging

Presentation
Shower tray + imperband kit
Shower tray + imperband kit
Shower tray + imperband kit
Shower tray + imperband kit
Shower tray + imperband kit
Shower tray + imperband kit

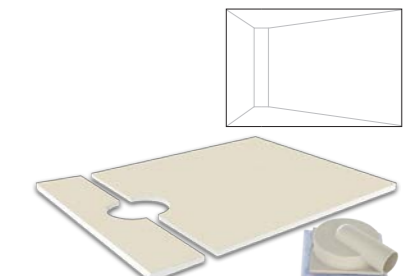

LINEAR CENT R Central grating

KEA	SAP	Rectangular shower tray	P/EU
B88000364	100114469	1000X800x30	612,00 p/u
B88000386	100114478	1200X900x30	632,40 p/u
B88000391	100114472	1200X1000x30	637,50 p/u
B88000377	100114480	1400X900x30	652,80 p/u
B88000389	100114486	1500X900x30	688,50 p/u
B88000372	100114489	1600X900x30	703,80 p/u
B88000382	100114492	1800X900x30	724,20 p/u

Packaging

Presentation
Shower tray + imperband kit
Shower tray + imperband kit
Shower tray + imperband kit
Shower tray + imperband kit
Shower tray + imperband kit
Shower tray + imperband kit

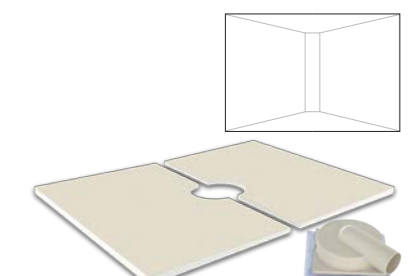

All the **concept xps** shower trays have available a 50 mm thickness special piece to increase the height of the shower tray and cover sewer and drain. Check conditions with your sales representative from PORCELANOSA GRUPO.



Bespoke shower trays

If you need a shower tray with certain dimensions or shape that cannot be found in our standard shower trays range, **butech** can make the shower tray with the shape and dimensions you need.

Just send us a drawing with the dimensions and shape you want for your shower tray and we will give you a price and a delivery date. If you agree, we will make your custom shower tray.

For making a square or rectangular shower tray, we need the following information:

- Shower tray dimensions:
 - Long side xP
 - Wide side yP
 - Thickness: choose among 30/40 mm
- Grating type
 - Square grating
 - Linear grating choose among 59.6/80/120 mm
- Drain position
 - Long side xS
 - Wide side yS

All dimensions must be entered in millimeters.

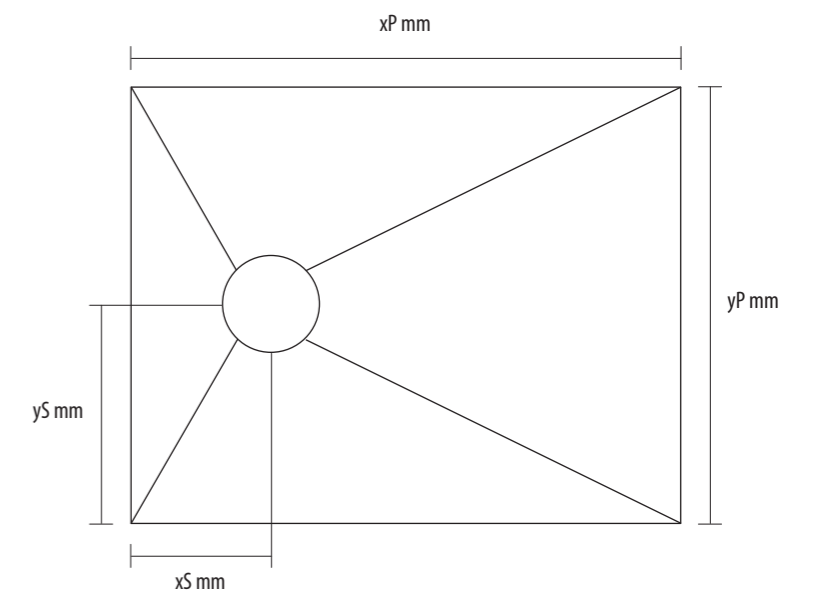

All custom drains include the **imperband kit** corresponding to the thickness of the chosen board.

Decorative grating is not included. Refer to page 126-127.

All the custom **concept xps** shower trays have available a 50 mm thickness special piece to increase the height of the shower tray and cover sewer and drain. Check conditions with your sales representative from PORCELANOSA GRUPO.

In case you need a shower tray with a non orthogonal shape, check with **butech** sales department.

Bespoke standard shower trays

These shower trays feature a 40 mm thickness.

It includes the **imperband standard kit**.

Does not include **square gratings**.

concept xps shower trays

ESQ Q Corner grating

KEA	SAP	Square tray	P/EU
B88000224	100103244	1-1000X<1000X40	351,95 p/u
B88000235	100103240	1001-1200X<1200X40	420,77 p/u
B88000219	100103254	1201-1400X<1400X40	489,58 p/u
B88000243	100103260	1401-1600X<1600X40	558,92 p/u

Packaging

Presentation
 Shower tray + imperband kit
 Shower tray + imperband kit
 Shower tray + imperband kit
 Shower tray + imperband kit

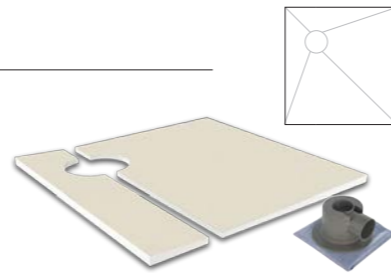

CENT Q Central grating

KEA	SAP	Square tray	P/EU
B88000205	100103242	1-1000X<1000X40	351,95 p/u
B88000203	100103238	1001-1200X<1200X40	421,29 p/u
B88000209	100103252	1201-1400X<1400X40	489,58 p/u
B88000229	100103258	1401-1600X<1600X40	558,92 p/u

Packaging

Presentation
 Shower tray + imperband kit
 Shower tray + imperband kit
 Shower tray + imperband kit
 Shower tray + imperband kit

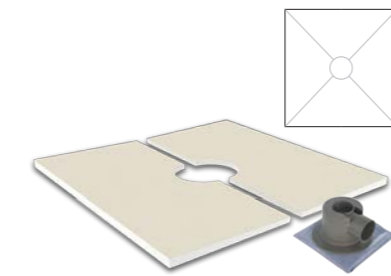

LAT R Lateral grating

KEA	SAP	Rectangular shower tray	P/EU
B88000211	100103245	1-1000X<901X40	354,05 p/u
B88000222	100103241	1001-1200X<901X40	355,63 p/u
B88000208	100103255	1201-1400X<901X40	492,73 p/u
B88000231	100103261	1401-1600X<901X40	562,07 p/u
B88000215	100103268	1601-1800X<901X40	631,94 p/u
B88000228	100103272	1801-2000X<901X40	701,80 p/u
B88000238	100103274	2001-2200X<901X50	772,19 p/u

Packaging

Presentation
 Shower tray + imperband kit
 Shower tray + imperband kit
 Shower tray + imperband kit
 Shower tray + imperband kit
 Shower tray + imperband kit
 Shower tray + imperband kit
 Shower tray + imperband kit

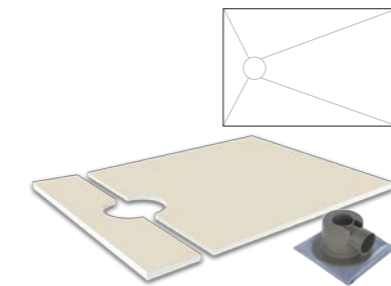

The maximum length of the wide side of this type of tray is 900 mm. For higher lengths, check with **butech** sales department.

CENT R Central grating

KEA	SAP	Rectangular shower tray	P/EU
B88000223	100103243	1-1000X<901X40	354,05 p/u
B88000202	100103239	1001-1200X<901X40	356,15 p/u
B88000241	100103253	1201-1400X<901X40	490,63 p/u
B88000226	100103259	1401-1600X<901X40	562,07 p/u
B88000221	100103269	1601-1800X<901X40	632,46 p/u
B88000233	100103271	1801-2000X<901X40	701,80 p/u
B88000242	100103273	2001-2200X<901X50	772,19 p/u

Packaging

Presentation
 Shower tray + imperband kit
 Shower tray + imperband kit
 Shower tray + imperband kit
 Shower tray + imperband kit
 Shower tray + imperband kit
 Shower tray + imperband kit
 Shower tray + imperband kit

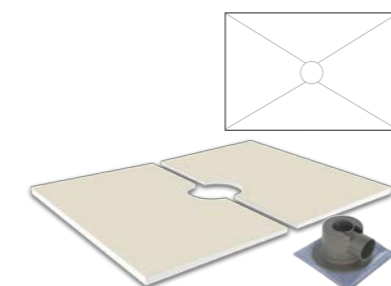

The maximum length of the wide side of this type of tray is 900 mm. For higher lengths, check with **butech** sales department.

Square gratings

Square gratings

KEA	SAP	Square grating	P/EU
B82902094	100148572	squared usa	34,65 p/u
B82902021	100089372	squared	23,02 p/u
B82902056	100114593	sun	44,84 p/u

Packaging

Presentation
 1 grating/box
 1 grating/box
 1 grating/box



Bespoke standard shower trays for linear grating

These shower trays feature a 40 mm thickness.

It includes the **imperband standard kit**.

Does not include **linear gratings**.

concept xps shower trays

LINEAR LAT Q Linear grating

KEA	SAP	Square tray	P/EU
B88000438	100116102	1-1000X<1000X40	632,40 p/u
B88000429	100116110	1001-1200X<1200X40	652,80 p/u
B88000416	100116118	1201-1400X<1400X40	673,20 p/u
B88000400	100116126	1401-1600X<1600X40	688,50 p/u

Packaging

Presentation
 Shower tray + imperband kit
 Shower tray + imperband kit
 Shower tray + imperband kit
 Shower tray + imperband kit

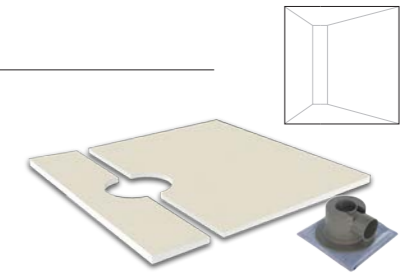

LINEAR CENT Q Linear grating

KEA	SAP	Square tray	P/EU
B88000437	100116100	1-1000X<1000X40	632,40 p/u
B88000410	100116108	1001-1200X<1200X40	652,80 p/u
B88000419	100116116	1201-1400X<1400X40	673,20 p/u
B88000405	100116124	1401-1600X<1600X40	688,50 p/u

Packaging

Presentation
 Shower tray + imperband kit
 Shower tray + imperband kit
 Shower tray + imperband kit
 Shower tray + imperband kit

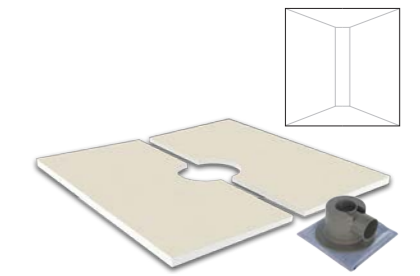

LINEAR LAT R Lateral grating

KEA	SAP	Rectangular shower tray	P/EU
B88000440	100116103	1-1000X<901X40	632,40 p/u
B88000433	100116111	1001-1200X<901X40	652,80 p/u
B88000434	100116119	1201-1400X<901X40	673,20 p/u
B88000344	100110295	1401-1600X<901X40	688,50 p/u
B88000343	100110164	1601-1800X<901X40	693,60 p/u
B88000412	100116136	1801-2000X<901X40	765,00 p/u
B88000415	100116140	2001-2200X<901X50	816,00 p/u

Packaging

Presentation
 Shower tray + imperband kit
 Shower tray + imperband kit
 Shower tray + imperband kit
 Shower tray + imperband kit
 Shower tray + imperband kit
 Shower tray + imperband kit
 Shower tray + imperband kit

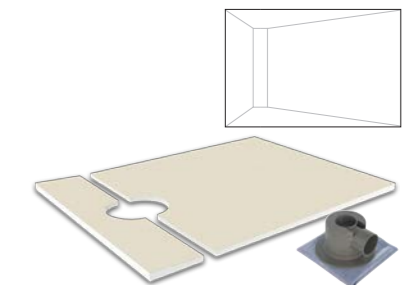

The maximum length of the wide side of this type of tray is 900 mm. For higher lengths, check with **butech** sales department.

LINEAR CENT R Central grating

KEA	SAP	Rectangular shower tray	P/EU
B88000441	100116101	1-1000X<901X40	632,40 p/u
B88000399	100116109	1001-1200X<901X40	652,80 p/u
B88000408	100116117	1201-1400X<901X40	673,20 p/u
B88000403	100116125	1401-1600X<901X40	688,50 p/u
B88000421	100116131	1601-1800X<901X40	693,60 p/u
B88000424	100116135	1801-2000X<901X40	765,00 p/u
B88000401	100116139	2001-2200X<901X50	816,00 p/u

Packaging

Presentation
 Shower tray + imperband kit
 Shower tray + imperband kit
 Shower tray + imperband kit
 Shower tray + imperband kit
 Shower tray + imperband kit
 Shower tray + imperband kit
 Shower tray + imperband kit

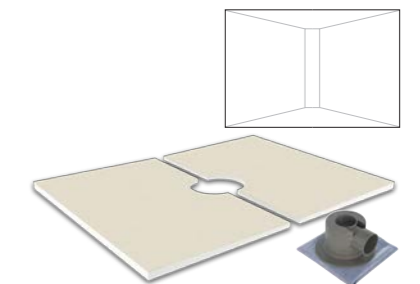

The maximum length of the wide side of this type of tray is 900 mm. For higher lengths, check with **butech** sales department.

Linear gratings

Information referring to linear gratings is on page 143.

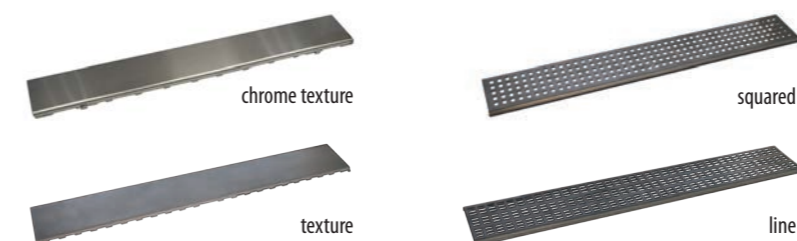

Select the linear grid depending on the shower tray width, so that the minimum distance between the grid and the concept xps shower tray sides exceeds 100 mm on both sides. We recommend to follow the instructions given in the table below:

Grid length:	Shower tray width:
59.6 x 9.3 cm	> 800 mm
80 x 9.3 cm	> 1000 mm
120 x 9.3 cm	> 1400 mm

The shower tray width corresponds to the second digit of the columns corresponding to Rectangular Shower Tray and Square Shower Tray

Bespoke refurbishing shower trays

These shower trays feature a 30 mm thickness.
It includes the **imperband refurbishing kit**.
Does not include **square gratings**.

concept xps shower trays

ESQ Q Corner grating

KEA	SAP	Square tray	P/EU
B88000250	100103290	1-1000X<1000X30	371,91 p/u
B88000254	100103286	1001-1200X<1200X30	440,20 p/u
B88000263	100103303	1201-1400X<1400X30	509,54 p/u
B88000266	100103309	1401-1600X<1600X30	577,83 p/u

Packaging

Presentation
Shower tray + imperband kit
Shower tray + imperband kit
Shower tray + imperband kit
Shower tray + imperband kit

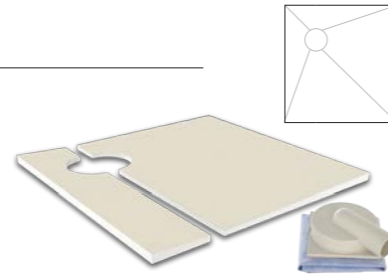

CENT Q Central grating

KEA	SAP	Square tray	P/EU
B88000251	100103288	1-1000X<1000X30	364,62 p/u
B88000244	100103284	1001-1200X<1200X30	431,57 p/u
B88000267	100103301	1201-1400X<1400X30	499,04 p/u
B88000275	100103307	1401-1600X<1600X30	566,50 p/u

Packaging

Presentation
Shower tray + imperband kit
Shower tray + imperband kit
Shower tray + imperband kit
Shower tray + imperband kit

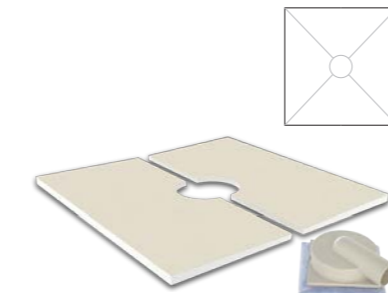

LAT R Lateral grating

KEA	SAP	Rectangular shower tray	P/EU
B88000246	100103291	1-1000X<901X30	366,17 p/u
B88000258	100103287	1001-1200X<901X30	367,71 p/u
B88000268	100103304	1201-1400X<901X30	501,61 p/u
B88000278	100103310	1401-1600X<901X30	570,62 p/u
B88000265	100103317	1601-1800X<901X30	638,60 p/u
B88000273	100103321	1801-2000X<901X30	707,61 p/u
B88000270	100103323	2001-2200X<901X30	776,62 p/u

Packaging

Presentation
Shower tray + imperband kit
Shower tray + imperband kit
Shower tray + imperband kit
Shower tray + imperband kit
Shower tray + imperband kit
Shower tray + imperband kit
Shower tray + imperband kit

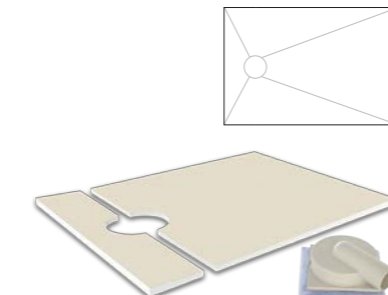

The maximum length of the wide side of this type of tray is 900 mm. For higher lengths, check with **butech** sales department.

CENT R Central grating

KEA	SAP	Rectangular shower tray	P/EU
B88000255	100103289	1-1000X<901X30	374,01 p/u
B88000245	100103285	1001-1200X<901X30	375,06 p/u
B88000274	100103302	1201-1400X<901X30	509,54 p/u
B88000281	100103308	1401-1600X<901X30	583,08 p/u
B88000276	100103318	1601-1800X<901X30	651,37 p/u
B88000280	100103320	1801-2000X<901X30	722,81 p/u
B88000284	100103322	2001-2200X<901X30	793,20 p/u

Packaging

Presentation
Shower tray + imperband kit
Shower tray + imperband kit
Shower tray + imperband kit
Shower tray + imperband kit
Shower tray + imperband kit
Shower tray + imperband kit
Shower tray + imperband kit

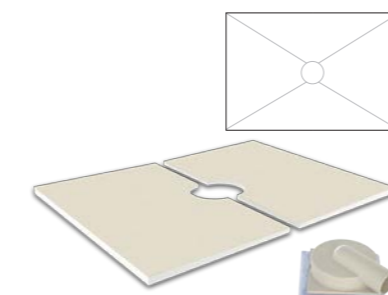

The maximum length of the wide side of this type of tray is 900 mm. For higher lengths, check with **butech** sales department.

All the **concept xps** shower trays have available a 50 mm thickness special piece to increase the height of the shower tray and cover sewer and drain. Check conditions with your sales representative from PORCELANOSA GRUPO.

Bespoke refurbishing shower trays for linear grating

These shower trays feature a 30 mm thickness.
It includes the **imperband refurbishing kit**.
Does not include **linear gratings**.

concept xps shower trays

LINEAR LAT Q Linear grating

KEA	SAP	Square tray	P/EU
B88000413	100116098	1-1000X<1000X30	632,40 p/u
B88000404	100116106	1001-1200X<1200X30	652,80 p/u
B88000406	100116114	1201-1400X<1400X30	673,20 p/u
B88000432	100116122	1401-1600X<1600X30	688,50 p/u

Packaging

Presentation
Shower tray + imperband kit
Shower tray + imperband kit
Shower tray + imperband kit
Shower tray + imperband kit

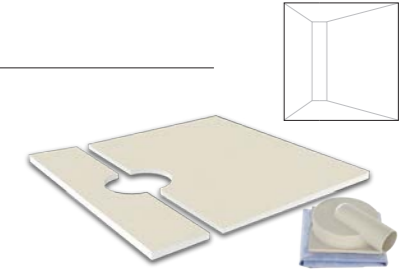

LINEAR CENT Q Linear grating

KEA	SAP	Square tray	P/EU
B88000443	100116096	1-1000X<1000X30	632,40 p/u
B88000402	100116104	1001-1200X<1200X30	652,80 p/u
B88000420	100116112	1201-1400X<1400X30	673,20 p/u
B88000431	100116120	1401-1600X<1600X30	688,50 p/u

Packaging

Presentation
Shower tray + imperband kit
Shower tray + imperband kit
Shower tray + imperband kit
Shower tray + imperband kit

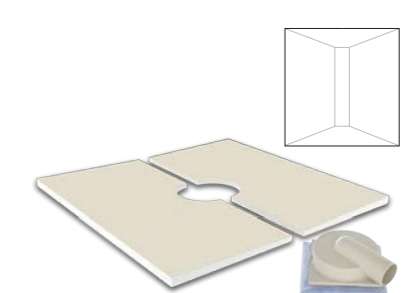

LINEAR LAT R Lateral grating

KEA	SAP	Rectangular shower tray	P/EU
B88000418	100116099	1-1000X<901X30	632,40 p/u
B88000427	100116107	1001-1200X<901X30	652,80 p/u
B88000409	100116115	1201-1400X<901X30	673,20 p/u
B88000436	100116123	1401-1600X<901X30	688,50 p/u
B88000435	100116130	1601-1800X<901X30	693,60 p/u
B88000417	100116134	1801-2000X<901X30	765,00 p/u
B88000425	100116138	2001-2200X<901X30	816,00 p/u

Packaging

Presentation
Shower tray + imperband kit
Shower tray + imperband kit
Shower tray + imperband kit
Shower tray + imperband kit
Shower tray + imperband kit
Shower tray + imperband kit
Shower tray + imperband kit

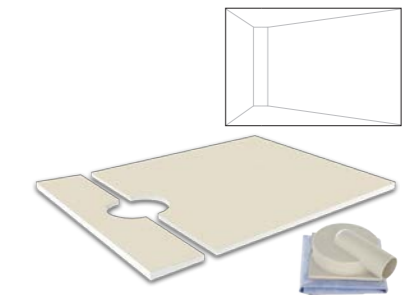

The maximum length of the wide side of this type of tray is 900 mm. For higher lengths, check with **butech** sales department.

LINEAR CENT R Central grating

KEA	SAP	Rectangular shower tray	P/EU
B88000442	100116097	1-1000X<901X30	632,40 p/u
B88000407	100116105	1001-1200X<901X30	652,80 p/u
B88000422	100116113	1201-1400X<901X30	673,20 p/u
B88000423	100116121	1401-1600X<901X30	688,50 p/u
B88000430	100116129	1601-1800X<901X30	693,60 p/u
B88000411	100116133	1801-2000X<901X30	765,00 p/u
B88000428	100116137	2001-2200X<901X30	816,00 p/u

Packaging

Presentation
Shower tray + imperband kit
Shower tray + imperband kit
Shower tray + imperband kit
Shower tray + imperband kit
Shower tray + imperband kit
Shower tray + imperband kit
Shower tray + imperband kit

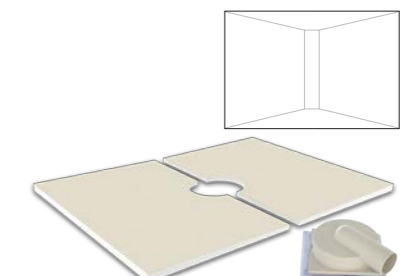

The maximum length of the wide side of this type of tray is 900 mm. For higher lengths, check with **butech** sales department.

All the **concept xps** shower trays have available a 50 mm thickness special piece to increase the height of the shower tray and cover sewer and drain. Check conditions with your sales representative from PORCELANOSA GRUPO.



Altea cabin

Shower cabin with circular tray with 100 cm radius and 200 cm height. Specially recommended for health resorts and outdoors.

This circular shower includes the following elements:

- Circular shower tray.
- Panels for circular walls.
- Drain system.

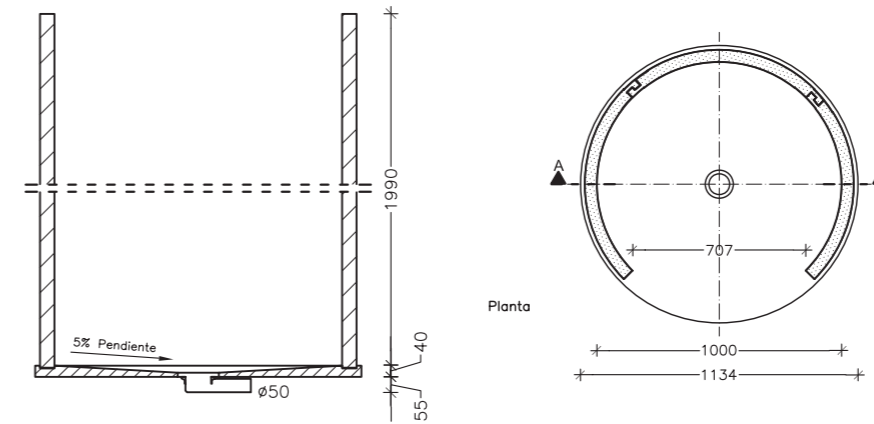

Altea concept shower

KEA	SAP		P/EU
B88000447	100116226	2.000 x 1000 x 1000	1822,74 p/u

Victoria cabin

Shower cabin with circular tray with 100 cm radius and 200 cm height. Specially recommended for bathroom refurbishings.

This circular shower includes the following elements:

- Circular shower tray
- Panels for circular walls
- Drain system.

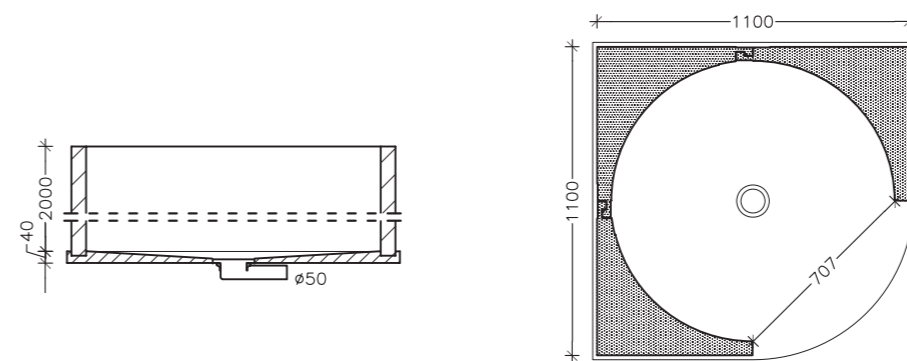

Victoria corner concept shower

KEA	SAP		P/EU
B88000445	100116227	1.100 x 1.100 x 2.000	2034,90 p/u

Niágara cabin

Snail shaped shower cabin with 59 cm entrance and 200 cm high. Specially recommended for health resorts and outdoors.

This snail-shaped shower includes the following elements:

- Shower tray.
- Panels for circular walls.
- Drain system.

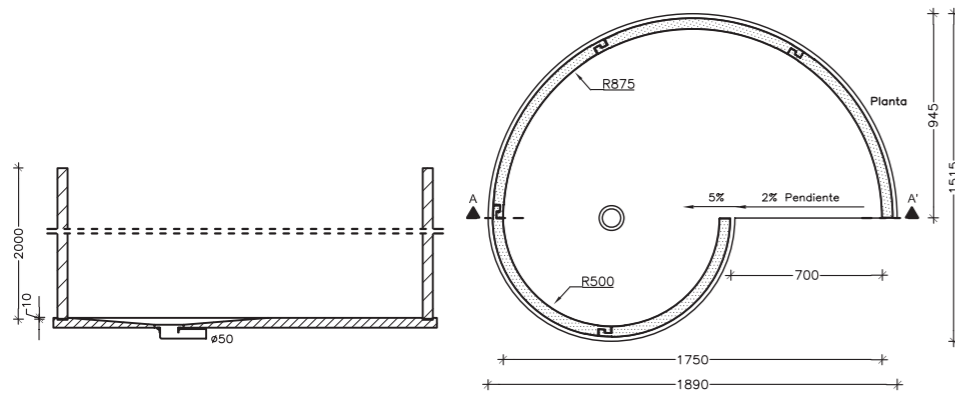

Niágara concept shower

KEA	SAP		P/EU
B88000448	100116228	1890 x 1515 x 2000 right entrance	2789,70 p/u

concept benches

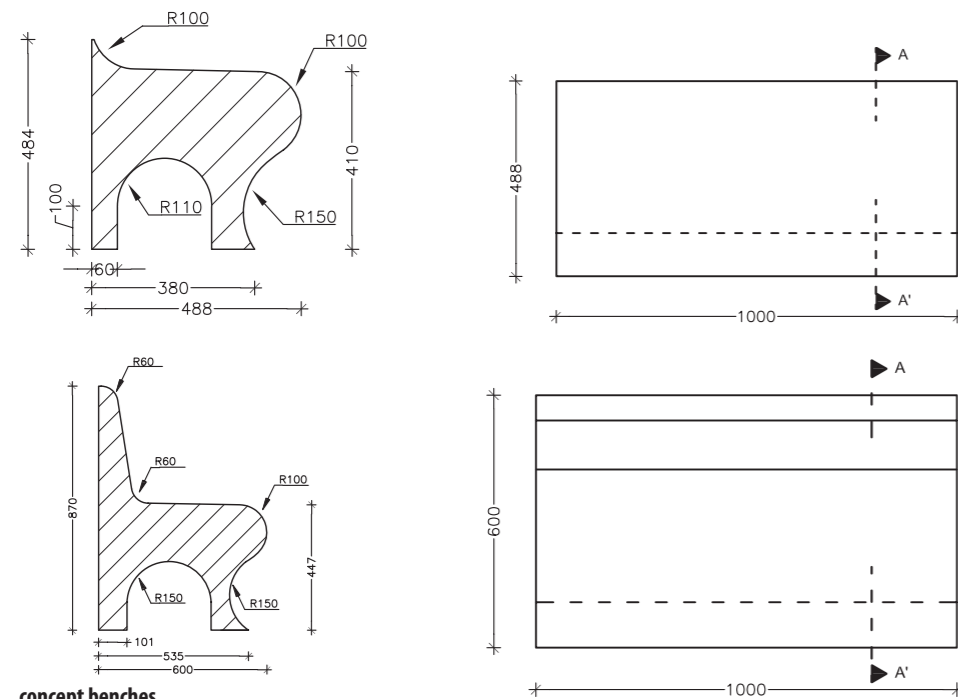

concept benches

KEA	SAP		P/EU
B88000446	100116223	1000X484X484 backless bench	319,77 p/u
B88000451	100116224	1000X600X870 backed bench	529,38 p/u

Iguazú cabin

Rectangular cabin, 180 cm long, 100 cm wide and 228.9 cm high, with 60 cm entrance. Specially recommended for health resorts.

This shower includes the following elements:

- Shower tray.
- Panels for walls.
- concept bench.
- Flat ceiling.
- Drain system.

Taps, main door, manhole cover and plumbing not included.

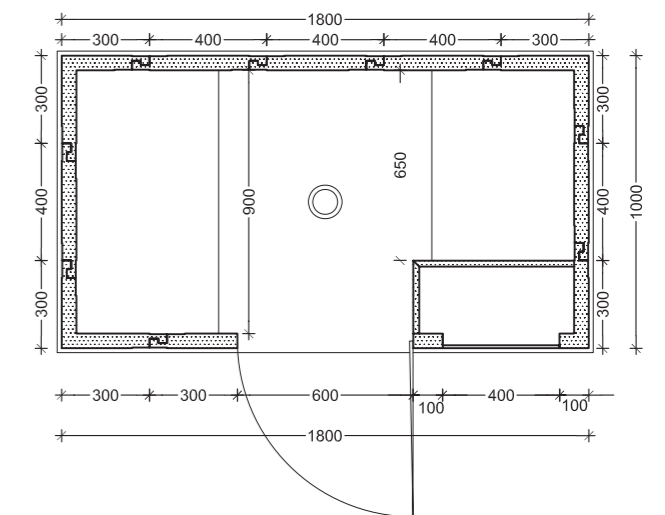
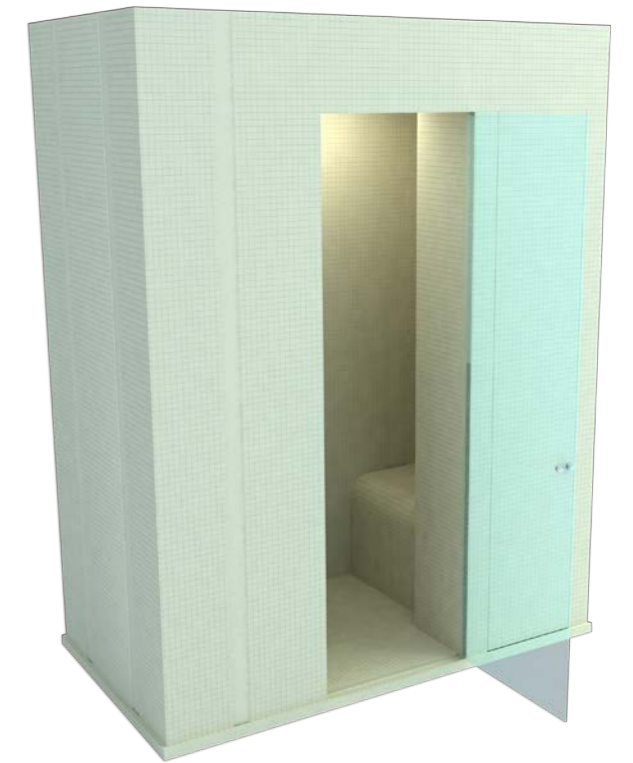
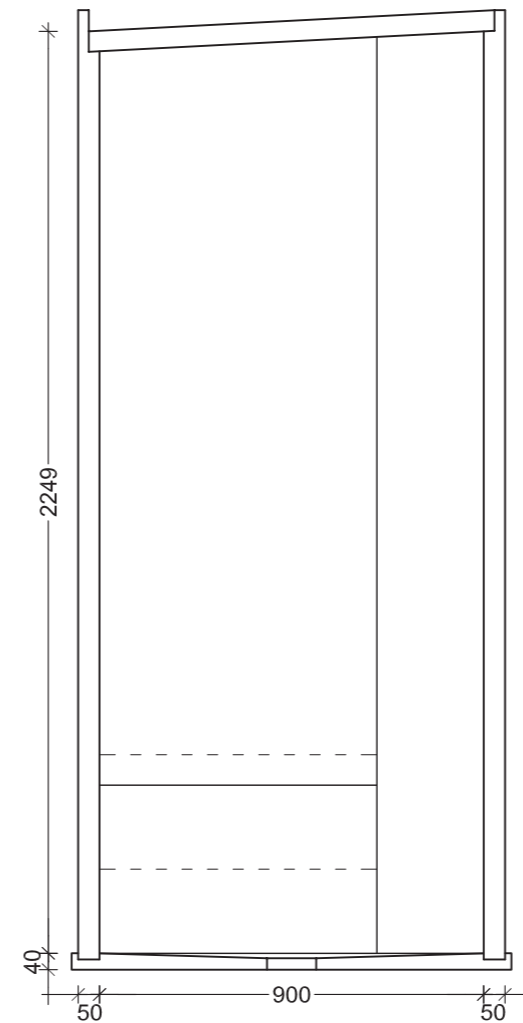

Iguazú vapor cabin

KEA	SAP		P/EU
B88000449	100116225	1800X1000X2300	5140,8 p/u

Product family Adhesivos cementosos

Product name flexitec n

Image of a possible use of the product 

flexitec n
flexitec n es un adhesivo cementoso tipo C2 TE, apto para colocación de gres porcelánico, sobre fondos de base cemento o soportes flexibles como el cartón yeso. Especialmente recomendado por su excelentes condiciones de uso.
Adhesivo base cemento de elasticidad media para la colocación en capa fina de cerámicas absorbentes, gres y gres porcelánico. Tautotípico.

Product name flexitec n

Product features
Características:

- Adhesivo cementoso monocomponente.
- Excelente adherencia. Deformabilidad media.
- Mortero de textura fina, con óptimas condiciones de preparación amasado y aplicación.
- Alta adherencia inicial sin deslizamiento vertical.
- Tiempos de trabajo prolongados. Tiempo abierto mayor de 30 min.
- Espesor de aplicación de hasta 6 mm.
- Resiste la helada.
- Agua de amasado: 7,0 - 7,5 l por saco de 25 Kg

Aplicaciones recomendadas:

- Revestimientos interiores.
- Pavimentos porcelánicos interiores y exteriores.

Types of applications where the use of the product is recommended

Product Coverage
Consumo:

Baldosa 20 x 30 cm	3 kg / m ²
Baldosa 30 x 30 cm	3 kg / m ²
Baldosa 30 x 60 cm	4 kg / m ²
Baldosa 44 x 44 cm	4 kg / m ²
Baldosa 30 x 90 cm	5 kg / m ²
Baldosa 44 x 66 cm	5 kg / m ²

Materiales:

- Baldosas cerámicas absorbentes de formato grande.
- Baldosas cerámicas no absorbentes de formato mediano.
- Gres porcelánico (absorción de agua < 0,5% según EN-ISO 10545-3).

Types of materials where the use of the product is recommended

Product certifications and standards
Certificados / normativas:
 Certiflic CSTB Certified: CSTB 1061-222 MC 299
 EN 12004 C2 TE

Product name flexitec n

Types of substrates where the use of the product is recommended
Soportes:

- Soleras y revocos de mortero de cemento.
- Placas de hormigón.
- Placas de cartón yeso.
- Sobre fondos de anhidrita o yeso, aplicar uniprim.

Types of substrates where the use of the product is recommended

Product name flexitec n

Type of packaging for the product
Embalaje

Presentación	Europalet
Saco 25 kg	1000 kg / pallet
Saco 25 kg	1000 kg / pallet

Product picture 

Value 62

Symbols for types of substrates
 urbatik ston-ker gran formato cartón yeso piscinas exterior

Eligible
Non-eligible
Mixed with cl-stuk

A					
acid net pro	130	pro-corner B	54	pro-part line	36
acid net 1L	131	pro-corner E	54	pro-part line matt	36
acid net +	131	pro-corner mosaik	54	pro-part moon	34
		pro-corner R	54	pro-part moon line	34
B				pro-part ocean	32
basic gel 1L	131	pro-dilata CFC PVC	65	pro-part ocean line	32
bt-3000 n	89	pro-dilata CFI PVC	65	pro-part oxyde	38
bathroom drain	126	pro-dilata CFL PVC	65	pro-part rose	28
		pro-dilata CFM aluminium	66		
		pro-dilata CFM inox	66	pro-plint aluminium	71
		pro-dilata CFP PVC	66	pro-plint aluminium R	71
				pro-plint inox	71
C		pro-flex	69		
cerancol	76			pro-sanit S1	70
cl-stuk	116	pro-level C aluminium	62	pro-sanit S3	70
colorstuk 0-4	97	pro-level C chrome	62	pro-sanit U1	70
colorstuk 2-12	99	pro-level M aluminium	62	pro-sanit U2	70
colorstuk cleaner	132	pro-level R aluminium	62		
colorstuk especial n	101			pro-shower	63
colorstuk rapid n	103	pro-mate 2 inox V2A	49		
colorstuk sealer	133	pro-mate 2 inox V4A	49	pro-skirting alumínio	72
concealed façade fixing	93			pro-skirting cromado	72
concept panel xps	151	pro-mate 3 aluminium	50		
concept shower trays xps	159	pro-mate 3 chrome	43, 50	pro-step aluminium	68
concept shower xps	172			pro-step chrome	68
		pro-mate 45 aluminium	55	pro-step PVC	68
E		pro-mate 45 brass	55	pro-step W	45
electric radiant floor heating	107	pro-mate 45 inox	55		
epotech	109	pro-mate 45 PVC brillo	56	pro-T aluminium	61
epotech aqua	105	pro-mate 45 PVC II	56	pro-T brass	61
epotech cleaner	132	pro-mate 45 PVC mate	56	pro-T chrome	61
epotech crystal	107	pro-mate 45 top	56	pro-T inox	61
epotech gold & silver	108				
epotech nature	106	pro-mate 5 aluminium	21	pro-telo aluminium	46
		pro-mate 5 brass	22	pro-telo carbono	45
		pro-mate 5 chrome	20	pro-telo inox	46
F		pro-mate 5 chrome SW 168	43, 51	pro-telo mosaik	43
flexitec n	79	pro-mate 5 chrome SW 500	26	pro-telo recto	46
fonolax	92	pro-mate 5 gold	22	pro-telo W chrome	45
fonopac R	119	pro-mate 5 gold SW 168	20		
fr-one especial	82	pro-mate 5 gold SW 500	40	R	
fr-one n	81	pro-mate 5 graphite	51	rapimax n	87
		pro-mate 5 oxyde	38		
		pro-mate 5 chrome SW Glass	24	S	
		pro-mate 5 gold SW Glass	24	s-107	113
				s-107 n	114
I		pro-part aluminium	53	self-leveling spacers	111
imperband	139	pro-part antique	30	square grid	144
imperband refurbishing kit	142	pro-part brass	37	structural joints AT	67
imperband standard kit	141	pro-part chrome	43, 53	structural joints BT	67
imperbox	137	pro-part crystal SW Gold	12	super-drain	148
		pro-part crystal SW Silver	12	super-flex S2	86
		pro-part crystal SW Graphite	12	super-one n	85
L		pro-part gold	26	super-prim	129
lamitech n	147	pro-part graphite	40	sylastic	145
level 1 n	125	pro-part graphite matt	42		
level 1 pro	126	pro-part graphite matt line	42	T	
level 3	127	pro-part inox	53	terrace drain	146
linear grid	143			thermocem	124
		pro-part Li aluminium	52	tixocem	77
N		pro-part Li chrome	43, 52	tixocem plus	78
non-slip tile	133	pro-part Li chrome SW 1500	18		
		pro-part Li crystal rock SW graphite	10	U	
M		pro-part Li crystal rock SW Silver	10	unicem	123
maxifluid	88	pro-part Li crystal sand SW Gold	14	unilax	91
		pro-part Li crystal sand SW Silver	14	uniprim	128
O		pro-part Li crystal SW Galaxy	8		
one-flex n	83	pro-part Li gold	26	V	
one-flex n sp	84	pro-part Li gold SW 1500	18	visible facade fixings	94
		pro-part Li Pearls SW Gold	16		
P		pro-part Li Pearls SW Silver	16		
p-404	115				
politech n	90				
porce-clean	132				
pro-balcony	64				

Spain Showrooms

A CORUÑA
SANTIAGO DE COMPOSTELA -PORCELANOSA
General Pardiñas, 13-Bajo.
T: 981 569 230 - F: 981 569 230
SANTIAGO DE COMPOSTELA - PORCELANOSA
Rua Polonia, Pol. Comercial Costa Vella
T: 981 897 595 - F:981 530 901
SANTIAGO DE COMPOSTELA - PORCELANOSA
Rua Clara Campoamor, 13-15 (Montouto)- Teo
T: 981 509 270 - F: 981 819 334
A CORUÑA - SUMINISTROS VIA-MAR
México Rodríguez 18-20. T: 981 279 431 - Fax: 981 279 431
BETANZOS - SUMINISTROS VIA-MAR
Avenida Fraga Iribarne, s/n. T: 981 772 190 - Fax: 981 774 257
FERROL - NEIRA & ORTEGAL S.L.
Carretera Catabois, 258. T: 981 326 532 - F: 981 324 951
ORTIGUEIRA - NEIRA & ORTEGAL S.L.
Carretera C-642 s/n, Cuiña. T: 981 400 880 - F: 981 400 883
PUEBLA DEL CARAMIÑAL - PEREZ DOMINGUEZ PUEBLA.S.L.
Angustia, 30. T: 981 830 214 - F: 981 107 219

ÁLAVA
VITORIA-GASTEIZ - JORGE FERNÁNDEZ
Los Herrán, 30. T: 945 254 755 - F: 945 259 668
VITORIA-GASTEIZ - JORGE FERNÁNDEZ
Polígono Jundiz, Paduleta, 53. T: 945 244 250 - F: 945 229 321

ALBACETE
ALBACETE - PORCELANOSA
Avda. Gregorio Arcos, 32 (Polígono Campollano)
T: 967 243 658 - F: 967 193 465
VILLARROBLEDO - OLIVARES MAT. CONSTRUCCIÓN
Avda. Reyes Católicos, 168. T: 967 138 105 - F: 967 138 023

ALICANTE
ALICANTE - PORCELANOSA
Pol. Las Atalayas, Parcela VI. Calle del Franco.
T: 965 109 561 - F: 965 106 965
SAN JUAN - PORCELANOSA
Carretera Valencia, km 88. T: 965 656 200 - F: 965 655 644
BENISSA - HIJOS DE JUAN RIBES
Avda. de la Estación, 2. T: 965 730 419
ELCHE - PORCELANOSA
Avda. Alicante, 105. T: 966 610 676 - F: 966 610 700
JAVEA - AZULEJOS JAVEA
C/Liverpool, 4. T: 965 791 036
ALTEA - ELDECO
Ctra. N-332 Partida Cap. Blach, 38 A.
T: 966 874 360 - F: 966 873 543
DENIA - NOVA RECAL
Avda. Alcoy, 2. T: 965 786 034
ALCOY - SANEAMIENTOS COLÓN S.A.
Avda. De la Alameda, 10. T: 965 331 891 - F: 965 524 210

ALMERÍA
ALMERÍA - PORCELANOSA
Avenida Mediterráneo, 2º tramo. T: 950 143 567 - F: 950 142 067
VICAR - PORCELANOSA
Centro Comercial Viapark, Parcela 1. T: 950 325 575 - F: 950 338 651

ASTURIAS
OVIEDO- PORCELANOSA
Pol. Espíritu Santo C/Dinamarca/s/n. T: 985 791 526 - F: 985 985 963
GIJÓN - PORCELANORTE
Menéndez Pelayo 30. T: 984 396 462

ÁVILA
ÁVILA - PAVIMARSA
Pol. industrial Nicolozano -Parcela 2. T: 920 259 820 - F: 920 259 821

BADAJOZ
MÉRIDA - PORCELANOSA
Avenida Reina Sofía, 8. T: 924 330 218 - F: 924 330 315
BADAJOZ - GALLERY CERAMIC
Carretera N-V Madrid-Lisboa, km 399. T: 924 229 144 - F: 924 229 143
HERRERA DEL DUQUE - JUBEL
Avda. Juan Carlos I, s/n. T: 924 145 372
ZAFRA - MUNDO OBRAS
Bodión, 27. Pol. Ind. Los Caños. T: 924 551 264 - F: 924 551 264

BARCELONA

L'HOSPITALET DE LLOBREGAT - PORCELANOSA
Ciències, 65. Gran Via l'Hospitalet. T: 932 642 500 - F: 932 007 036

SANT SADURNI D'ANOIA - COMERCIAL STC
Rambla Generalitat. 59. T: 931 593 137 - F: 931 615 015

BARCELONA - AZULEJOS SAN ANDRÉS
Plaça Mossen Clapes 2-3. T: 933 455 102 - F: 933 461 015

CORNELLÀ - LOFT CUINA
La Miranda, 6-8. T: 934 743 793 - F: 937 741 305
MOLINS DE REI - HIJO DE FERNANDO ROCA
Pla, 9. T: 936 681 434 - F: 936 801 458

CABRERA DE MAR - ORMAT
Ctra. Vilassar-Argentona Km1. T: 937 591 139 - F: 937 502 076
SANT POL DE MAR - AMARGANT
Passeig Parc, 1. T: 937 600 112 - F: 937 600 411
PINEDA DE MAR - AMARGANT
Santiago Rusiñol, 96. T: 937 671 416 - F: 937 627 488
MATARÓ - ROSA JORDANA RABETLLAT
Montserrat, 7. T: 937 903 089 - F: 937 903 089

VILANOVA DEL CAMÍ - ROSA JORDANA RABETLLAT
Montserrat, 108-111. T: 938 060 240 - F: 938 060 239
TARADELL - JODIL
Ctra. Vic, km 5,8. T: 938 800 800 - F: 938 126 054
GIRONELLA - ANTONI PONT
Farguell, 31. T: 938 228 088 - F: 938 250 786
SANTPEDOR - CONSAN
Pol. Ind. Les Verges. T: 938 320 669 - F: 938 320 669
SANT BOI DE LLOBREGAT - GARRO
Ctra. Creu de Clafell, Km 10,7. T: 936 545 952 - F: 938 400 620
CANOVELLES - COMERCIAL MAESTRO CANET
Pol. Can Castells, nave 7-8. T: 938 466 568 - F: 938 409 216
TORELLÓ - JOAN DOT
Ter, 50. T: 938 504 646 - F: 938 504 286
TORELLÓ - ARQUIMATT MATERIALS I DECORACIÓ
Sant Jordi, 16. T: 937 531 877
CALAF - PLANELL
Ctra. Manresa, Km 31. T: 938 698 750 - F: 938 600 181
PALAU SOLITA I PLEGAMANS - COMERCIAL SOLSAN
Cami Reial, 109. T: 938 648 125 - F: 938 649 617
VIC - CORRETTJA
Mas de Bigas, 8-26. T: 938 854 261 - F: 938 894 733
ST. PERE DE RIBES - SUMICO
Ctra. Barcelona C246, Km 42,4. T: 938 933 066 - F: 938 936 004
CUBELLES - MA-CO
Penedes / La Selva Pol. Ind. Les Salines.
T: 938 954 141 - F: 938 954 142
MATARÓ - MARESMÉ GRES
Sant Isidor, 78. T: 931 615 015
CASSERES - MATERIALS CASSERRES
San Rafael. T: 938 213 770
TIANA - BADALONA GRESS
CR B-500, Km 3,2. T: 933 950 311 - F: 934 650 758
VILAFRANCA DEL PENEDÉS - FERRET I CAULLERAS
Sant Martí, 2. T: 938 170 353
SANTA MARIA PALAUJORDERA - RIERA MAGATZEM CONSTRUCCIÓ
Antiqua Via Provincial, 2. T: 938 670 764

BURGOS
MIRANDA DE EBRO - JORGE FERNÁNDEZ
Camino Fuente Basilio, S/N. T: 947 323 351 - F: 947 314 589
BURGOS - BIGMAT FONTECHA
Alcalde Martin Cobos, naves 5 y 6. T: 947 485 153 - F: 947 483 941
ARANDA DE DUERO - GRUPO DISMAR DUERO
Avda. Portugal, Parcela 17. T: 947 513 28 - F: 947 513 349

CÁCERES
MORALEJA - BIGMAT CAYUELA
Avda. Extremadura, 26. T: 927 515 198 - F: 927 147 266
VALENCIA DE ALCANTARA - BIGMAT TEJEDA
Pol. Ind. Cerro San Francisco, s/n. T: 924 410 155 - F: 927 668 016
CÁCERES - PORCELANOSA
Avda. Juan Pablo II, 130. T: 927 236 337 - F: 927 236 205
PLASENCIA - GEMAT
Avda. Ambroz, 5-7. T: 927 316 828
MONTEHERMOSO - GEMAT
Ctra. Pozuelo de Zazon, s/n. T: 927 430 597
NAVALMORAL DE LA MATA - MAGERVYSA
Rio salor, 83. T: 927 535 234 - F: 927 535 575

CÁDIZ
OLVERA - ALMECOR
Avda. Julian Besteiro, 29. T: 956 120 776 - F: 956 120 776
JEREZ DE LA FRONTERA - PORCELANOSA
Parque Empresarial Avda De la Ilustración, 1.
T: 956 187 160 - F: 956 302 904
UBRIQUE - DOCURRI
Paseo del Prado 38-40. T: 956 462 263 F: 956 462 623
ALGECIRAS - PORCELANOSA
Ctra. Málaga, Km 190. T: 956 635 282 - F: 956 635 285
VILLAMARTÍN - AZULGRIF
Rosario, 9. T: 956 730 687 - F: 956 730 911
PUERTO SANTA MARÍA - PORCELANOSA
Pol. El Palmir. Ctra. Madrid-Cádiz, Km 653,2
T: 956 540 084 - F: 956 872 464
SAN FERNANDO - PORCELANOSA
Pol. Tres Caminos, S/N. T: 956 592 360 - F: 956 884 677

CANTABRIA
SANTANDER - PORCELANOSA
Avenida Parayas, s/n. T: 942 352 510 - F: 942 352 638
TORRELAVEGA - PORCELANOSA
Boulevard Demetrio Herrero, 1. T: 942 835 026 - F: 942 881 787

CASTELLÓN
CASTELLÓN DE LA PLANA - PORCELANOSA
Asensi, 9. T: 964 239 162 - 964 238 930
VILLARREAL - PORCELANOSA
Ctra.Vila-real - Puebla de Arenoso (CV- 20) Km. 0,7
T: 964 506 800 - F: 964 525 418
VINARÓZ - PORCELANOSA
Carretera N-340, km 1.050,1. T: 964 400 944 - F: 964 400 650

CEUTA
CEUTA - BAEZA.
Ampliación muelle de Poniente, 96. T: 956 511 312 - F: 956 511 309

CIUDAD REAL
CIUDAD REAL - PORCELANOSA
Ctra. de Carrion, Km.11. T: 926 251 730 - F: 926 255 741

CÓRDOBA
CÓRDOBA - PORCELANOSA
Ctra. Nacional IV Km.404. Pol. de Torreclilla.
T: 957 760 024 - F: 957 760 123
POZOBLANCO - ACAÑAS CABRERA
Ctra. pozoblanco-Alcaracejos Km 3,3
T: 957 772 999 - F: 957 131 170
VILLA DEL RIO - JUAN PRIETO E HIJOS S.L.
Ctra. Bujalance, s/n. T: 957 177 693 - F: 957 177 335
HINOJOSA DEL DUQUE - HORMIGONES SANFRANCISCO
Velázquez, 13. T: 957 140 181
PRIEGO DE CÓRDOBA - SANEAMIENTO Y REVESTIMIENTOS JULIO
Camino Fontanal s/n. T: 957 540 943
MONTILLA - ALMACENES MANOLIN Y LUIS S.L.
Avda. Andalucía, 24. T: 957 651 509 - F: 957 653 253
LUCENA - AUDOS CERÁMICAS
Éjido Plaza de Toros, 35. T: 957 516 572.
CASTRO DEL RIO - COMERCIO DE MATERIAL DE CONSTRUCCIÓN Y TRANSPORTES
Ronda de Jesús, 68. T: 957 372 775 - F: 957 372 775

CUENCA
CUENCA - VICOSAZ
Hermanos BecerriI, 6 bajo. T: 969 233 200 - F: 969 234 475
CASAS DE HARO - MAT. CONST. MARTINEZ ORTEGA
Dos de Mayo, 28. T: 969 380 708 - F: 969 380 708
TARANCÓN - VICENTE DE LOS RIOS S.A.
Avda del Progreso, 19. T: 969 321 323 - F: 969 321 334
VILLANUEVA DE LA JARA - ALMACENES PAÑOS S.L.
Camino de Rubielos, 8. T: 967 498 000 - F: 967 498 000

GERONA
BLANES - BRECOR SL
Ctra.Tordera,79. T: 972 336 062 - F: 972 358 482
PALAMOS - TG NOVA ARQUITECTURA
Avgda. Catalunya, 91. T: 972 312 250 - F: 972 312 249
PALOL D'ONYAR-QUART - OLIVERAS
Ctra. Comarcal C-250 Km. 4,3. T: 972 468 119 - F: 972 468 123
SANT FELIU DE GUIXOLS - GINESTA
Santa Magdalena, 11. T: 972 320 529 - F: 972 321 616

LLORET DE MAR - CARMONA
Ctra. Lloret Vidrere Km2,1. T: 972 372 710 - F: 972 349 763
GIRONA - GIROP
Llora, 5. T: 972 393 200 - F: 972 393 071
SALT - FULCARA BRUGUE XAVIER
Rafael Maso, 56. T: 972 234 591 - F: 972 402 284
CORNELLÀ DEL TERRI - OLIVERAS
Ctra. Girona-Banyoles, km 12,8. T: 972 594 131 - 972 594 552
ESCLANYÀ BEGUR - MATERIALS CREIXELL
Palafrugel Regenos. Pol. Ind. Riera Esclanya, 1. T: 972 300 628
FIGUERES - OLIVERAS
Ctra. N-II, km 759. T: 972 672 259 - F: 972 672 255
VILA-SACRA - FRIAS MATERIALS
Castello, 72. T: 972 670 073 - F: 972 673 071
LES PRESSES - OLIVERAS
Pol. Ind Les Presses, parcel.la 20. T: 972 694 704 - F: 972 693 003
CANET DE TALLADA - SERVIMAT INICIATIVES
Ctra. C-31 Km 354. T: 972 780 524 - F: 972 780 827
ARBUCIES - ARC ARBUCIES CERAMIQUES
Pol. Ind. Cal Xic- Parc, 4. T: 972 162 364 - F: 972 860 954

VILA-SACRA - FRIAS MATERIALS
Castello, 72. T: 972 670 073 - F: 972 673 071
LES PRESSES - OLIVERAS
Pol. Ind Les Presses, parcel.la 20. T: 972 694 704 - F: 972 693 003
CANET DE TALLADA - SERVIMAT INICIATIVES
Ctra. C-31 Km 354. T: 972 780 524 - F: 972 780 827
ARBUCIES - ARC ARBUCIES CERAMIQUES
Pol. Ind. Cal Xic- Parc, 4. T: 972 162 364 - F: 972 860 954
SARRIÀ DE TER - FERRER CERVIÀ
Avda. França, 192. T: 972 173 442 - F: 972 173 456
MONT-RÀS - MERCAMAT
Ctra. C-31 Km 329,8. T: 972 612 027 - F: 972 302 146

GRANADA
ARMILLA - TECMACER
Avenida San Rafael. (Junto Sprinter).
T: 958 253 081 - F: 958 183 367

GUIPÚZCOA
SAN SEBASTIÁN - JORGE FERNÁNDEZ
Polígono Belartzta. Fernando Mújika, 15.
T: 943 376 966 - F: 943 376 841

HUELVA
HUELVA - PORCELANOSA
Ctra. Tráfico Pesado, s/n Pol. La Paz.
T: 959 543 600 - F: 959 237 951

HUESCA
HUESCA - PORCELANOSA
Pol. Sepes. C/ Ronda la Industria 1-3 nave C.
T: 974 242 738 - F: 974 242 676
FRAGA - BERGES CENTRO COMERCIAL
Avda. Aragón, 70. T: 974 471 439 - F: 974 471 439
AIMSA - COMERCIAL CAMPODARVE
Pol. Ind. Sobrarbe, naves 11 y 12
T: 974 500 267 - F: 974 500 865

ILLES BALEARS
PALMA DE MALLORCA - PORCELANOSA
Gran Via Asima, 21. Pol. Son Castelló.
T: 971 430 667 - F: 971 297 094

INCA (MALLORCA) - PORCELANOSA
Pagesos s/n. Pol. Inca. T: 971 507 650 - F: 971 507 656
LLUCMAJOR (MALLORCA) - MAGATZEM SES FORQUES
Doctor Fleming, 10. T: 971 662 114 - F: 971 662 816

Spain Showrooms

SOLLER - PORCELANOSA
Del Mar,193. T: 971 630 219
MANACOR - PORCELANOSA
Via Palma, 102. T: 971 554 502
CALA D' OR- MACODOR
Ctra. Calonge -Cala D'or, Km 1,5. T: 971 658 210
SANT RAFAEL-SANT ANTONIO - PORCELANOSA
Avda. Llauradors, 7. Pol. Monte Cristo. T: 971 317 292 - F: 971 317 293

JAÉN
JAÉN - PORCELANOSA
Polígono Olivares. Carretera Bailén-Motril, km 32,3.
T: 953 280 757 - F: 953 284 035
ALCALA LA REAL - PAVIMENTOS AZUGRISA
Polígono Ind. Fte. Granada Vial II. T: 953 582 963
BEAS DE SEGURA - GRUPO PEREA MORANTE S.L.
Polígono El Cornicabral, parcela 517 T: 953 424 565
HUELMA - VIFERSAN S.L.
Virgen de la Fuensanta, 61. T: 953 391 413
LINARES - HERNÁNDEZ GÁMEZ S.L.
Ctra. Torreblascopedro, s/n. T: 953 693 423 - F: 953 693 444
ÚBEDA - HERNANDEZ GAMEZ.
Avenida de la libertad, 88. T: 953 795 168 - F: 953 795 168
VILLACARRILLO - MAT. CONST. Y SAN. HIJOS MARTIN SANCHEZ
C/ José Rodero Mataran, 53. T: 953 454 167

LA RIOJA
LOGROÑO - RIOJACER
Avenida de Burgos, 43-45. T: 941 286 021 - F: 941 202 271

LAS PALMAS
LAS PALMAS DE GRAN CANARIA - PORC. Y PAV. CANARIOS
Avenida Mesa y López, 61. T: 928 472 949 - F: 928 472 944

LEÓN
SAN ANDRÉS DE RABANEDO - PORCELANOSA
Ctra León- Astorga, km 3,5. - San Andrés de Rabanedo -
T: 987 801 570 - F: 987 801 475
PONFERRADA - DISEÑARTE BIERZO S.L.
Avda. Galicia 380 - T: 987 455 870

LÉRIDA
EL PONT DE SUERT - PRETENSATS RIBERA
Ctra. N-230 Km. 124,5. T: 973 690 063 - F: 973 690 400
LA SEU D'URGEL - MATERIALS PIRINEU
Ctra. de Urdel, 28. T: 973 351 850 - F: 973 353 410
LLEIDA - MATERIALS GERMANIS MAURI
Príncipe Viana, 36. T: 973 232 139 - F: 973 247 943
VIELHA - PRETENSATS RIBERA
Ctra. França, 40 (Mig Aran). T: 973 641 460 - F: 973 642 271
TARREGA - NOUMAG
Júpiter, 7 (Pol. Ind. La Canaleta). T: 607 497 330
BALAGUER - J FARRÉ
Urgell, 39. T: 973 445 765 - F: 973 445 072
SOI.SONIA - JORDI VILAR
Ctra. Manresa, Km 50. T: 973 482 077 - F: 973 482 373
LLEIDA - PROMOCIÓ DE PREFABRICADOS S.L.
Ivars d'Urgell, 20. Pol. Ind. Neoparc.
T: 973 603 954 - F: 973 603 950
MOLLERUSA - PROMOCIÓ DE PREFABRICADOS S.L.
Avda. Canal 8. Baixos. T: 687 542 944
LLEIDA - PUJOL ELEMENTS
Tarragona, 40. T: 973 202 350 - F: 973 203 113

LUGO
FOZ - ALMACENES BAHIA
Maestro Lugilde, 6. T: 982 140 957 - F: 982 132 065
LUGO - ARIAS NADELA
Tolda de Castilla, s/n. T: 982 245 725
XOVE - ESTABLECIMIENTOS REY S.L.
Avda. Diputación, 88. T: 982 592 006 - F: 982 592 071
CHANTADA - SONIA GÓMEZ GÓMEZ
Juan XXIII, 22. T: 982 441 249 - F: 982 440 331

MADRID
LEGANÉS - PORCELANOSA
Avda. Recomba, 13. Pol. La Laguna Salida 53 - M50.
T: 914 819 200 - F: 916 930 292
ALCOBENDAS - PORCELANOSA
Parque Río Norte. T: 916 623 232 - F: 916 624 607
ALCORCÓN - PORCELANOSA
Ctra. N-V, km 15,5. Parque Oeste de Alcorcón.
T: 916 890 172 - F: 916 890 170
MADRID - PORCELANOSA
Ortega y Gasset, 62. Esquina Conde Peñalver.
T: 914 448 460 - F: 914 025 111
MADRID - PORCELANOSA
Alcalá, 514. T: 917 545 161 - F: 917 545 555

MÁLAGA
MÁLAGA - PORCELANOSA
Avda. Velázquez, 77. T: 952 241 375 - F: 952 240 092
MARBELLA - PORCELANOSA
Avda. Ricardo Soriano, 65. T: 952 826 868 - F: 952 822 880
RONDA - MARMOLERA RONDEÑA
Guadalevín, 12. Pol. Ind El Fuerte. T: 952 872 225
VELEZ - MATERIALES MUÑOZ PEREZ
Ferrocarril, 2. T: 952 507 879 - F: 952 504 760

MELILLA
MELILLA - FERRETERIA MODERNA E HIJOS
Paseo Marítimo Mir Berlanga, 19. T: 952 671 144 - F: 952 671 285

MURCIA
MURCIA - PORCELANOSA
Avda. Juan de Borbón, s/n. Parque Comercial Thader.
T: 968 879 527 - F: 968 831 725
CARAVACA DE LA CRUZ - PORCELANOSA
Avda. Ctra. Granada, 20. T: 968 705 647 - F: 968 705 648
EL ALGAR - AZULEJOS ZAPATA PEÑALVER S.L.
Ctra. La Palma, s/n. T: 968 135 480 - F: 968 135 000
LORCA - PORCELANOSA
Ctra. de Granada, 127. Polígono Los Peñones.
T: 968 478 130 - F: 968 470 820

NAVARRA
MULTIVA BAJA - MONTEJO CERÁMICAS
Pol. Ctra. Tajonar, Calle A, Naves 2-4.
T: 948 239 065 - F: 948 230 503
CINTRUENIGO - CERÁMICAS CECILIO CHIVITE
Pol. Ind. s/n. Variante N-113. T: 948 811 973 - F: 948 815 249
PAMPLONA - MONTEJO CERÁMICAS
Navas de Tolosa, s/n. T: 948 224 000 - F: 948 226 424
TUDELA - MONTEJO CERÁMICAS
Ctra. Tudela -Tarazona, Pol. Centro de Servicios de Tudela.
T: 948 848 365 - F: 948 848 573

OURENSE
OURENSE - BLANCO QUINTAS
Nosa Señora da Sainza, 48. T: 988 391 114 - F: 988 250 413
CARBALLIÑO - JOSE R. PITEIRA S.L.L.
Avda. Julio Rodríguez Soto, 63. T: 988 271 071 - F: 988 274 780

PALENCIA
PALENCIA - CANTALAPIEDRA
La Puebla, 2. T: 979 706 421 - F: 979 702 652

PONTEVEDRA
DENA - PREFABRICADOS DENA S.L.
Rua Galicia, 24. T: 986 743 121 - F: 986 745 131
SEIXO, MARIN - SANEAMIENTOS ROSALES
Avenida Doctor Otero Ulloa, 1. T: 986 702 041 - F: 986 702 880
O GROVE - PREFABRICADOS DENA S.L.
Alexandre Boveda, 82. T: 986 702 041- F: 986 733 415
LALÍN - ALMACENES CANDAS S.L.
Montserrat, 36-39 B. T: 986 780 184 - F: 986 782 301
MOS - BLANCO QUINTAS, S.L.
Monte Faguinha s/n - B. T: 986 288 041 - F: 986 486 316
SILLEDA - ARCOLAR 2000 S.L.
Rua Venezuela, 40. T: 986 580 114 - 986 592 513
VIGO - SANEAMIENTOS ROSALES
García Barbón, 139 B. T: 986 228 806

SALAMANCA
VILLARES DE LA REINA - PORCELANOSA
Pol. Villares. Ctra. Salamanca - Valladolid, km 2,2.
T: 923 243 811 - F: 923 123 414

SANTA CRUZ DE TENERIFE
SANTA CRUZ DE TENERIFE - PORC. Y PAV. CANARIOS
Avda. 3 de Mayo, 18. T: 922 209 595 - F: 922 209 596
LOS LLANOS DE ARIDANE - AFELSA
Las Rosas, s/n. T: 922 461 112 - F: 922 461 166
SANTA CRUZ DE LA PALMA - AFELSA
Abenguaerne, 3. T: 922 412 143 - F: 922 420 012
SANTA MIGUEL - PORC. Y PAV. CANARIOS
Avenida Claudio Delgado Díaz, 59. T: 649 298 137

SEGOVIA
EL ESPINAR - SEGOCEER
Carretera Madrid-La Coruña,

International Showrooms

ALBANIA

TIRANA – ALBA CERÁMICA PORCELANOSA
T: +355 42233817 - F: +355 42233817

TIRANA – ALBA CERAMICA
T: +355 48300084 - F: +355 48300084

ALEMANIA

ASCHAFFENBURG – KALKWERKE
T: +49 (0) 60 213 601 62 - F: +49 (0) 60 213 602 93
 BAD SALZUFLEN – W. LINNENBECKER GmbH
T: +49 (0) 5222 / 5301 221 - F: +49 (0) 5222 / 5301 209
 BADEN BADEN – E. Wertheimer GmbH
T: +49 (0) 7221 50020 - F: +49 (0) 722171080
 BAUTZEN – FLIESEN LEHMANN GmbH
T: +49 (0) 3591 / 3726 32 - F: +49 (0) 351 / 8931420

BEESKOW – BADER BAUSTOFFE & WERKZEUGE, HANDELSGESELLSCHAFT T:GmbH
+49 (0) 3366 / 417 0 - F: +49 (0) 3366 / 417 90
 BERGISCH GLADBACH – SCHMIDT RUDERSDORF GmbH & Co
T: +49 (0) 2204 / 4007 0 771 - F: +49 (0) 3320 / 854715

BERLIN – W. LINNENBECKER GMBH & CO. KG
T: +49 (0) 30 / 756 888 - F: +49 (0) 30 / 756 88 756
 BERLIN – FLIESEN PARADISES GLAESKE + SEFZIG GmbH
T: +49 (0) 30 650 737 0 - F: +49 (0) 30 650 737 34
 BERLIN – BERLINER FLIESENMARKT GmbH
T: +49 (0) 30 326 725 10 - F: +49 (0) 30 326 725 58
 BOFFZEN – HERMANN BACH GmbH & CO. KG
T: +49 (0) 5271 / 955 251 - F: +49 (0) 5271 / 955 200

BONN – SCHMIDT-RUSSERDORF
T: +49 (0) 228 55 916 0
 BOTTROP – W. LINNENBECKER GMBH & CO. KG
T: +49 (0) 2041 / 7958 13 - F: +49 (0) 2041 / 7958 10
 BURGSTÄDT – FLIESEN THOMAS FLIESENGRÖßHANDEL GMBH
T: +49 (0) 3724 / 1856 0 – F: +49 (0) 3724 / 1856 70
 DORTMUND – W. LINNENBECKER GMBH & CO. KG
T: +49 (0) 231 / 562 090 22 - F: +49 (0) 231 / 562 090 88

DOSSENHEIM – SENGEWITZ FLIESENGALERIE
T: +49 (0) 6221 874440 - F: +49 (0) 6221874442
 DOSSENHEIM – FLIESEN GALERIE SENGEWITZ
T: +49 (0) 6221 874440 - F: +49 (0) 6221 874442
 ELTERLEIN – FLIESNHAUS MULLER
T: +49 (0) 37349 / 7305 - F: +49 (0) 37349 / 6093
 ERKRATH – W. LINNENBECKER GMBH
T: +49 (0) 211 / 92503 19 - F: +49 (0) 211 / 92503 34
 FREIBURG – GÖTZ & MORITZ GMBH
T: +49 (0) 76 145 180 - F: +49 (0) 76 145 711 2
 FULDA – OSWALD KERAMIK UND STEIN GMBH
T: +49 (0) 66 194 151 0 - F: +49 (0) 66 194 151 40
 GERA – BAUSTOFFE GEBR. LÖFFLER GMBH
T: +49 (0) 365 430 701 9 - F: +49 (0) 365 430 701 4
 GÖRLITZ – FLIESEN-PEDERSEN GMBH
T: +49 (0) 3581 / 402809 - F: +49 (0) 3581 / 409166
 HAMBURG – LURUP – CROONEN FLIESENHANDEL GMBH
T: +49 (0) 40 / 83383 377 - F: +49 (0) 40 / 83383 301
 KARLSTADT – FLIESEN GEHRET
T: +49 (0) 93 539 731 0 - F: +49 (0) 93 539 731 26
 KOBLENZ - J. N. KÖBIG GMBH - KOBLENZ

T: +49 (0) 26 198 169 20 - F: +49 (0) 26 198 169 10
 KRANICHFELD – MÜHL 24 - KRANICHFELD
T: +49 (0) 36 450 330 - F: +49 (0) 36 450 332 89
 LEVERKUSEN – SCHMIDT-RUDERSDORF
T: +49 02 14 - 8 68 13 0 - F: +49 02 14 - 8 68 13 13
 LÖBNITZ – SACHSENKERAM GBR
T: +49 (0) 34208 / 7400 - F: +49 (0) 34208 / 7400
 LÖBECK – HEINRICH 'S FLIESENMARKT
T: +49 (0) 451 896669 - F: +49 (0) 451 8973494
 MAINZ – J. N. KÖBIG GMBH - MAINZ
T: +49 (0) 61 313 943 10 - F: +49 (0) 61 316 942 75
 MESSECHED – W. LINNENBECKER GMBH & CO. KG
T: +49 (0) 291 / 952 82 21 - F: +49 (0) 291 / 952 82 82
 MÜNCHEN – CERAMICAS OHG

T: +49 (0) 89 318 280 0 - F: +49 (0) 89 318 280 20
 MÜNSTER – W. LINNENBECKER GMBH & CO. KG
T: +49 (0) 251 / 979 12 21 - F: +49 (0) 251 / 979 1220
 NORDHAUSEN – HERMANN BACH GMBH & CO. KG
T: +49 (0) 3631 / 633 126 - F: +49 (0) 3631 / 633 143
 NÜRNBERG/HAFEN – HEINRICH CHRIST GMBH & CO. KG
T: +49 (0) 91 164 318 0 - F: +49 (0) 91 164 318 50
 OFFENBURG – Maier + Kaufmann GmbH
T: +49 (0) 78196780 - F: +49 (0) 781967890
 POTS DAM – KERANA KERAMIK und Natursteinhandel GMBH
T: +49 (0) 33208 / 547 0 - F: +49 (0) 3381 7304501
 RADEBEUL – FLIESEN GHRLLICH & CO. GMBH
T: +49 (0) 351 / 89314 10 - F: +49 (0) 351 / 89314 20
 RÖNNENBERG/ EMPELDE – W.LINNENBECKER GMBH & CO. KG
T: +49 (0) 511 / 438 90 36 - F: +49 (0) 511 / 438 90 49
 SCHRAMBERG – SÜLGEN – ARMBRUSTER GMBH
T: +49 (0) 7422 28008-0 - F: +49 (0) 7422 28008-20
 STUTTGART – TAXIS - STUTTGART

T: +49 (0) 71 189 003 121 - F: +49 (0) 71 189 003 104
 UNTERGRUPPENBACH – KONZ & SCHAEFER HANDEL GMBH
T: +49 (0) 71312037480 - F: +49 (0) 71312037489
 VÖLKLINGEN – NIEDERER GMBH
T: +49 (0) 68 989 802 21 - F: +49 (0) 68 989 802 30
 WAIBLIGEN – KONZ FLIESENHANDEL GmbH
T: +49 (0) 7151149200 - F: +49 (0) 710510149-209

WÜRSELEN – SCHMIDT-RUDERSDORF

T: +49 (0) 24 05 - 41 38 50 - F: +49 (0) 24 05 - 41 38 55
 ZWETHAU – GRAMER GMBH
T: +49 (0) 3421 / 7327 18 - F: +49 (0) 3421 / 7326 73

ANGOLA

LUANDA-PORCELANOSA ANGOLA
T: +244 928463705 - F: +244 222372374

ARABIA SAUDÍ

JEDDAH – MANART AL ANDALOS EST
T: +966 2 629 3402 - F: +966 2 629 3416
 RIYADH – MANART AL ANDALOS EST
T: +966 1 282 1500
 AL AHSÄ – KHALED AL ANSARI SHOWROOM
T: +966 3 589 2888 - F: +966 3 5817043
 DAMMMAM – KHALED AL ANSARI VALENCIA SHOWROOM
T: +966 3 8180355 - F: +966 3 8188060
 DAMMMAM – MOHAMED M. AL DOSSARY STORES
T: 38348681 – F: +38340086

ARGELIA

ORAN – PORCELANOSA ORAN
T: +213 55505414/15
 ALGER – NOVACASA
T: +213 21 55 07 37 - F: +213 23 94 74 46

ARGENTINA

BUENOS AIRES – BLAISTEN S.A.
T: +54 11 463 620 00 - F: +54 11 463 614 86
 MAR DEL PLATA – IMEPHO S.A.
T: +54 223 481 3827

ARMENIA

YEREVAN – SACO & ARARAT-SALON BOMOND
T: +37 410 55 08 99 - F: +37 410 51 75 81

AUSTRALIA

BRISBANE – ACESTONES & TILES
T: +61 7 5493 3344 - F: +61 7 5493 3117
 NEWCASTLE – EARP BROST TILE
T: +61 2 4925 4555 - F: +61 2 4962 2926
 SYDNEY – EARP BROST TILE
T: +61 2 9410 3222 - F: +61 2 9410 2011
 MELBOURNE – EARP BROST TILE
T: +61 3 9328 8598 - F: +61 3 9348 9996
 ADELAIDE – ITALIA CERAMICS
T: +61 8 8336 2366 - F: +61 8 8336 9016
 OSBORNE PARK – MIDDLESWAN TRADING
T: +61 8 9445 1777 - F: +61 8 9446 3127
 HOBART – ROSSETTO TILING
T: +61 3 6231 2931 - F: +61 3 6231 5783
 LAUNCESTON – ROSSETTO TILING
T: +61 3 6326 4955 - F: +61 3 6326 6003
 BRISBANE – TILESCOPE IMPORTS
T: +61 7 3371 5777 - F: +61 7 3371 5133

AUSTRIA

INNSBRÜCK – FLIESEN CENTER TIROL
T: +43 512 364444
GRAZ – TENNE
 T: +43 316 262 524 0 - F: +43 316 262 524 22
LEIBNITZ – TENNE
 T: +43 3452 707 65 – F: +43 3452 707 29
BRUCK – TENNE
 T: +43 3862 588 44 – F: +43 3862 588 44-22
WIEN – TENNE
 T: +43 1 2020 520 – F: +43 1 2020 520-20
WIEN – BEINKOFER BEI BÄDERPARADIES
 T: +43 1 52242200 – F: +43 1 522422020
WIEN – BEINKOFER BEI HOLTNER
 T: +43 1 61516006900 – F: +43 1 61516006909
WIEN – FLIESEN FÜHRER HANDELS GmbH
 T: +43 1 5971 533 0 – F: +43 1 5971 533 28
LINZ – BEINKOFER
 T: +43 (0) 732 655 2550 – F: +43 (0) 732 655 25520
LINZ – BEINKOFER
 T: +43 732 776 543 0 – F: +43 732 776 543 60
SALZBURG – BEINKOFER
 T: +43 6624 69 09 69 20 – F: +43 6624 69 09 42 89
VÖSENDORF – TENNE VÖSENDORF
 T: +43 1 699 33 33 – F: +43 1 699 33 33-22
WELS – BEINKOFER
 T: +43 (0) 7242 25253210 – F: +43 (0) 7242 25253250
HALL – BEINKOFER BEI HOLTNER
 T: +43 (0) 5223 5046910 – F: +43 (0) 5223 5046919

AZERBAIJÁN

BAKU – AKSESUAR PORCELANOSA GRUPO
T: +994 12 5962548/+994 12 4973103 - F: +994 12 447 4383
 BAKU – AKSESUAR INSAAT
T: +994 12 546 74 86 - F: +994 12 546 74 86

BAHRÁIN

MANAMA – AL ABBAS GALLERY
T: +973 741 919 - F: +973 741 747

BANGLADESH

DHAKA – NUPAMI TRADING
T: +880 17837 01416
 DHAKA – NUPAMI
T: +880 1793567404

BÉLGICA

HEIST-OP-DEN-BERG – PGB CERAMICA NV
T: +32 (0) 15 253366 - F: +32 (0) 15 253367

BERMUDAS

PEMBROKE – PEMBROKE TILE & STONE Co. LTD
T: +441 292 8453 - F: +441 295 8453

BIELORRUSIA

GÓMEL – UNDERGROUND
T: +375 2327 76919 - F: +375 2327 76757
 MINSK – UNDERGROUND
T: +375 1721 78785 - F: +375 1721 75632
 MINSK – DOMIART
T: +375 17 259 60 33 - F: +375 17 259 6212

BOLIVIA

SANTA CRUZ – ELEMENTO DISEÑO & ARQUITECTURA
T: +591 3 364 7313 - F: +591 3 347 6226

BOSNIA Y HERZEGOVINA

CITLUK – BROTTIS d.o.o.
T: +387 633 21500 - F: +387 366 50950
 SARAJEVO – LUK d.o.o.
T: +387 33 777 888 - F: +387 33 777 889
 BANJA LUKA – LUK d.o.o.
T: +387 51 379 261/262 - F: +387 51 370 877
 BIJELJINA – LUK d.o.o.
T: +387 55 228 100 - F: +387 55 228 101

BRASIL

CAMPO LARGO – PORCELANOSA BRASIL REVESTIMENTOS LTDA
T: +55 (41) 3392 1500 - F: +55 (41) 3392 1400

BULGARIA

PETRICH – NIKMAR
T: +359 866 321 111 - F: +359 745 234 64
 SOFIA – NIKMAR
T: +359 2 868 93 95
 SOFIA – NIKMAR
T: +359 888 143 313
 SOFIA – ELE CERAMICA
T: +359 2 860 60 60
 VARNÄ – ELE CERAMICA
T: +395 52 500 555

CAMBOYA

PHNOM PENH – HOME LIVING
T: 855092434264

CANADÁ

VANCOUVER – FONTILE DISTRIBUTORS
T: +604 683 9358 - F: +604 683 6758
 MONCTON – DOMINION TILE & SUPPLIES
T: +506 857 8906 - F: +506 857 4149
 CALGARY – PORCELANOSA CALGARY
T: + (587) 349-2290

CHILE

SANTIAGO DE CHILE – BUDNIK HERMANOS S.A.
T: +562 398 0100 - F: +562 212 3058
 LAS CONDÉS – PORCELANOSA GRUPO CHILE SPA
T: +569 5 653 4306

CHINA

BEIJING – PO YICK DECORATION DESIGN COLTD
T: +861085271313 - F: +861064229976
 CHANGSHA –TAOTAOLE BUILDING MATERIALS COLTD
T: +86731899931787 - F: +86731899931786
 CHENGDU – DEHUA SANITARY EQUIPMENT
T: +86 28 8775 100181 - F: +86 28 8774721681
 CHONGQING –JIANGBEI YAO CHENG BUILDING MATERIALS
T: +86 23 86358360 - F: +86 23 86357182
 DALIAN – PO YICK BUILDING MATERIALS Co. Ltd.
T: +86 41182301911 - F: +86 41182301911
 FOSHAN – GUANGZHOU PO YICK DECORATION DESIGN CO LTD
T: +86 757 8278 2507 - F: +86 757 8278 5795
 FUZHOU – PO YICK BUILDING MATERIALS
T: +86 591 8805 5823 - F: +86 591 8805 5823
 GUANGZHOU – PO YICK BUILDING MATERIALS Co. Ltd. (FAFA)
T: +86 20 22008228 - F: +86 20 22008230
 GUANGZHOU – PO YICK BUILDING MATERIALS Co. Ltd. (MAFO)
T: +86 20 8701 8223 - F: +86 20 8701 8226
 HAIKOU – HAIKOU QIONGSHAN HUAXIN SANITARY BUILDING MATERIALS BUSINESSES
T: +86 8986532 2417 - F: +86 8986533 4893
 HANGZHOU – DA DOU BUILDING MATERIAL BUSINESS
T: +86 139 5814 9905
 HANGZHOU –MING OU BUILDING MATERIALS Co. Ltd.
T: +86 571 8658 2691 - F: +86 571 8608 5893

HARBIN-MING JIA LIVING SPACE BUILDING MATERIAL BUSINESS

T: +86 139 0450 4791
 JIANGYIN – PORCELANOSA BUILDING MATERIALS Co. Ltd.
T: +86 510 8169 3999 - F: +86 510 8169 3999
 JIAXING – JIAXING FEIFAN BUILDING MATERIALS
T: +86 573 8277 0662 - F: +86 573 8277 0662
 NANJING – XINGLANG BUILDING MATERIALS Co. Ltd.
T: +86 255 8823 208 - F: +86 255 8823 208
 QINGDAO – TUOLI SPACE BUILDING MATERIALS Co. Ltd.
T: +86 532 8099 5657 - F: +86 532 8099 5657
 SHANGHAI – PO YICK DECORATION DESIGN Co. Ltd.
T: +86 21 6438 3735 - F: +86 216 4281 607
 SHANGHAI – GUANGZHOU PO YICK DECORATION DESIGN Co. Ltd.
T: +86 216 4411 484 - F: +86 216 4281 607
 SHENYANG – BAO LU SHA PO YICK BUILDING MATERIALS Co. Ltd
T: +86 24 8563 7137 - F: +86 24 8563 7137
 SHENZHEN – PO YICK BUILDING MATERIALS Co. Ltd. (BAILIMA)
T: +86 755 8240 7728 - F: +86 755 8240 7738
 SHENZHEN – PO YICK BUILDING MATERIALS Co. Ltd. (HONGHU LU)
T: +86 755 2562 0359 - F: +86 755 2562 0344
 TIANJIN – OU LIN BUILDING MATERIALS Co. Ltd.
T: +86 22 2352 8765 - F: +86 22 8827 7023
 WENZHOU – MINGJIA INTERNATIONAL BUILDING MATERIALS Co. Ltd.
T: +86 577 8971 2011 - F: +86 577 8971 2066
 XIAMEN – PO YICK BUILDING MATERIALS SHOP
T: +86 952 3755 123 - F: +86 951 88055823

CHIPRE

LIMASSOL – THE ENGINEERING AND COMMERCIAL ASSOCIATION (EKA)
T: +357 2585 4444 - F: +357 2585 4545
 GIRNE – MEPAS LTD
T: +9039 2815 2964 - F: +9039 2815 5651
 NICOSIA – N. M. MARKOU BROS LTD
T: +357 2261 0740 - F: +357 2261 2162

COLOMBIA

BOGOTÁ – PORCELANOSA GRUPO COLOMBIA
T: +571 310 02 45
 BOGOTÁ – PROSEIN
T: +57 743 5566
 BARRANQUILLA – D.J.M.C.E.
T: +57 5 300 6208
 COREA DEL SUR
 SEOUL – T8.S TRADING CO. LTD
T: +82 234 438 600 - F: +82 234 438 822
 SEO-GU – COTTO CERAMIC CO LTD
T: +82 325 840 770 - F: +82 325 840 660
 BUSAN – COTTO CERAMIC CO LTD
T: +82 512 080 022 - F: +82 512 088558

COSTA RICA

SAN JOSE – FERNANDEZ AGUILAR S.A.
T: +506 2222 5674 - F: +506 221 9952

COSTA DE MARFIL

ABIDJAN – FADCO COMPANY
T: +225 21757355 - F: +225 21757358

CROACIA

DUBROVNIK – OTP DUBROVNIK
T: +385 20 412478 - F: +385 20 311521
 POREC – SPINA
T: +385 52 451 348 - F: +385 52 434 005
 PULA – SPINA
T: +385 52 219 002 - F: +385 52 219 118
 RIJEKA – SPINA
T: +385 51 741 300 - F: +385 51 741 298
 SPLIT – SPINA
T: +385 21 668 991 - F: +385 21 668 992
 VARAZDIN – SPINA
T: +385 42 303 707 - F: +385 42 303 709
 ZAGREB – SPINA
T: +385 13 492 552 - F: +385 13 492 560
 ZAGREB – ABC INTERJER
T: +385 16 393 164 - F: +385 16 055 985

DINAMARCA

GLOSTRUP – MOSAIKHJORNET
T: +45 43 633 900 - F: +45 43 663 857
 ODENSE M – DANESP FLJSE KOMPAGNIET APS
T: +45 66 173 221 - F: +45 66 173 821

ECUADOR

GUAYAQUIL – ARKETIP'S CA
T: +593 422 467 52 - F: +593 422 403 96
 QUITO – ARKETIP'S CA
T: +593 422 498 39 - F: +593 225 573 99

EGIPTO

EL CAIRO – MAHGOUB TRADING & IMPORTING
T: +20 2 57 12 265 - F: +20 2 57 39 344

EMIRATOS ÁRABES UNIDOS

DUBAI – GALAXY TRADING
T: +971 42696882

International Showrooms

MIDI-PYRÉNÉES:

TOULOUSE - PORCELANOSA TOULOUSE SAS

T: 05 34 56 57 60 - F: 05 34 56 57 86

NORD - PAS - DE - CALAIS:

LEZENNES - PORCELANOSA LILLE

T: +33 (0)320 340 340 - F: +33 (0)320 340 341

PAYS DE LA LOIRE:

BEAUCOUZE - PORCELANOSA ANGERS

T: +33 (0)241 738 100 - F: +33 (0)241 733 721

GUERANDE - PORCELANOSA LA BAULLE

T: +33 (0)240 607 273 - F: +33 (0)240 110 659

LA CHAPELLE SAINT AUBIN - PORCELANOSA LE MANS

T: +33 (0)243 236 520 - F: +33 (0)243 240 512

LA ROCHE SUR YON - PORCELANOSA LA ROCHE S /YON

T: +33 (0)251 241 217 - F: +33 (0)251 242 399

ORVAULT - PORCELANOSA NANTES

T: +33 (0)228 073 950 - F: +33 (0)228 073 957

POITOU - CHARENTES:

CHASSENEUIL DU POITOU - PORCELANOSA POITIERS

T: +33 (0)549 119 787 - F: +33 (0)549 119 788

PROVENCE - ALPES - CÔTE D'AZUR:

AUBAGNE - PORCELANOSA MARSEILLE

T: +33 (0)442 624 330 - F: +33 (0)442 624 339

NICE - PORCELANOSA Associate NICE

T: 493041963

MANDELIEU LA NAPOULE - PORCELANOSA CANNES

T: +33 (0)493 477 360 -F: +33 (0)493 477 402

LES PENNES MIRABEAU (PLAN DE CAMPAGNE) -

PORCELANOSA PLAN DE CAMPAGNE

T: +33 (0)442 466 120 - F: +33 (0)442 466 129

RHÔNE ALPES ET AUVERGNE:

CHAMPAGNE AU MONT D'OR - PORCELANOSA LYON

T: +33 (0)478 668 151 - F: +33 (0)478 432 003

SAINT-ÉTIENNE - PORCELANOSA Associate SAINT-ÉTIENNE

T: +33 (0) 477 305 676

GEORGIA

TBILISI - LUXOR SHOP

T: +995 32 2388898 - F: +995 32 2388399

GHANA

DZORWULU -ACCRA - ROUGE INTERIORS

T: +223 302 734752

GRECIA

ATTICA - AURORA BAGNO

T: +30 2105 594 520 - F: +30 2105 594 521

HATZ GROUP - PORCELANA:

ATHENS

T: 210 96 07 010 - F: 210 9607013

ATHENS

T: 210 5156 163 - F: 210 5156164

ATHENS

T: 2299041090 - F: 2299041095

GLUFADA

T: +30 2310 752 902 - F: +30 2310 753 564

KASTORIA

T: 2467044174

KATERINI

T: 2351076941 - F: 2351076940

KEFALONIA

T: 2671068360 - F: 26710 68 361

LARISA

T: 2410 619 999 - F: 2410 617444

LARISA

T: 2410561280

LEFKADA

T: 2645 0 72100 - F: 26450 29130

LOANNINA

T: 26510 92735 -7 - F: 26510 92738

NAFFAKTOS

T: 2634038393 - F: 26710 68 361

PATRA

T: 2610524000 - F: 2610523532

PATRA

T: 2610647474 - F: 2610242010

RHODES

T: 2241003315 - F: 2241003316

SERRES

T: 23210 36157

THESSALONIKI

T: 2310474767 - F: 2310 474403

THESSALONIKI

T: 2310700861 - F: 2310700861

THESSALONIKI

T: 2310753003 - F: 2310753003

TRILAKA

T: 2351076941

GUADALUPE (ANTILLAS FRANCESAS)

BAIE MAHAULT - GUADELOUPE CERAMIQUE

T: 590 266 261 - F: 590 266 412

SAINT BARTHELEMY - ALMA QUINCAILLERIE

T: +590 276 494 - F: +590 276 738

GUATEMALA

GUATEMALA- FERRETERIA DE LA CONSTRUCCION FERCO

T: 502 2421 9000 - F: 502 2421 9009

GUAYANA FRANCESA

CAYENNE - ETS HENRY LE GAC

T: +594 302 719 - F: +594 300 713

HAÍTÍ

PUERTO PRINCIPE - EUROCERAM

T: +509 250 57 14 - F: +509 250 57 15

HONG KONG

HONG KONG - TAI YICK BUILDING MATERIALS CO LTD

T: +852 23 956 670 - F: +852 23 957 831

HUNGRIA

BUDAPEST - PORCHUNGARY KFT

T: +36 1 237 08 78

BUDAPEST - PALATINUS FURDOSZOBASZALONOK

T: +36 61-430-04-17 - F: +36 1-387-91-36

DEBRECEEN -PALATINUS FURDOSZOBASZALONOK

T: +36 52-531-476 - F: +36 52 536-822

EGER - PALATINUS FURDOSZOBASZALONOK

T: +36 0636-312-013 - F: +36 0636-313-270

MISKOLC - PALATINUS FURDOSZOBASZALONOK

T: +36 46-412-741 - F: +36 46-416-256

BÉKÉSCSABA - PALATINUS FURDOSZOBASZALONOK

T: +36 66 328 432 - F: +36 66 328 432

GYÖNGYÖS - PALATINUS FURDOSZOBASZALONOK

T: +36 37 500 162 - F: +36 37 500 163

KECKSKEMÉT - PALATINUS FURDOSZOBASZALONOK

T: +36 76 412 272 - F: +36 76 509 204

INDIA

NEW DELHI - MARMO HOME PVT. LTD.

T: +91 11 47128800 - F: +91 11 2321 8728

INDONESIA

BANDUNG - WISMA SEHATI (BANDUNG BRANCH)

T: +62227238515 - F: +62227238516

JAKARTA - WISMA SEHATI (MANGGA DJIA BRANCH)

T: +62216013303 - F: +62216251221

JAKARTA - WISMA SEHATI (POLIM BRANCH)

T: +622172787711

JAKARTA - WISMA SEHATI (BSD)

T: +62215377278 - F: +62215377880

SEMARANG - WISMA SEHATI (SEMARANG BRANCH)

T: +62243562233 - F: +62243562222

SURABAYA - WISMA SEHATI (SURABAYA BRANCH)

T: +62315462868 - F: +62315462868

SOUTH JAKARTA - VIVERE

T: +62 21 290 56889

IRÁN

TEHRAN - FARBAR CO. LTD.

T: +98 21 88 03 6364 - F: +98 21 88 03 8283

IRAQ

ERBIL - AKSESUAR INSAAT ERBIL

T: +964 750 835 0055 - F: +964 66 210 1900

IRLANDA

CORK - O.B. HEATING, PLUMBING, BATHROOMS & TILES

T: +353 0 214 310 000 - F: +353 0 214 310 003

DUBLIN - TILESTYLE LTD

T: +00 353 1 8555200 - F: +00 353 1 8557471

ISLANDIA

REYKJAVIK - ALFABORG EHF

T: +354 568 6755 - F: +354 568 1277

ISLA REUNIÓN

SAINT DENIS - RAVATE PROFESSIONNEL SAS

T: +262 904 024 - F: +262 904 057

ISRAEL

BNEY BRAK - VIA ARCADIA

T: +972 3 614 2000 - F: +972 3 614 2020

RAANANA - AMOZI NAGAR IMP. MARK. OGEN LTD.

T: +972 9 760 1501 - F: +972 9 741 1997

RISHON LE ZION - NEGEV CERAMICS

T: +972 9 943 6676 - F: +972 9 6661

JERUSALEM - BAR- AMI 1990 LTD.

T: +972 2 531 3444 - F: +972 2 538 3740

BNEY BRAK - HEZI BANK

T: +972 3 616 6641 - F: +972 4 904 6643

BEERSHEVA - KIMCHI

T: +972 8 628 2060 - F: +972 8 623 2369

BETHLEHEM - AL-KHAYAL (BAYTOUNA)

T: +972 2 277 7279 - F: +972 2 274 4026

UPPER GALILY - KAMARIKA

T: +972 4 680 1010 - F: +972 4 680 0318

BEER SHEVA - NEGEV CERAMICS

T: +972 86280107

ELIAT - NEGEV CERAMICS

T: +972 86333638

HADERA - NEGEV CERAMICS

T: +972 46186068

JERUSALEM - NEGEV CERAMICS

T: +972 26714455

NAZARETH - NEGEV CERAMICS

T: +972 46462046

RAMAT GAN - NEGEV CERAMICS

T: +972 36155333

HAIFA - TOPOLSKI & CO LTD

T: +972 4 904 0496 - F: +972 4 904 0455

HAIFA - NEGEV CERAMICS

T: +972 48 466 444

ITALIA

BARI:

ANDRIA - MIDIL-CERAMICHE S.A.S

T: +39 08 835 66466 - F: +39 08 835 49260

MILANO:

CORSICO - PORCELANOSA LOMBARDIA S.P.A

T: +39 02 458 64310 - F: +39 02 458 64415

MODENA:

SASSUOLO - PORCELANOSA S.P.A

T: +39 05 368 06677 - F: +39 05 368 02184

ROMA:

ROMA - PORCELANOSA ROMA S.P.A

T: +39 06 888 9977 - F: +39 06 888 7056

CASSINO - CERAMICHE DUEP. S.R.L.

T: (+39) 07625142

BERGAMO - PORCELANOSA BERGAMO

T: (+39) 035299984 - F: (+39) 0352922085

MILAN - SPAZIO LIBIA 3

T: (+39) 0287246767

JERSEY

ST. SAVIOUR - PASTELLA GROUP

T: 01534 870167 - F: 01534 723199

JAPÓN

OSAKA - HIRATA TILES

T: 816 65321280

JORDANIA

AMMAN - AYMAN ABDALLAT & PARTNERS CO.

T: +9626 5504592 / 93 / 95 - F: +9626 5514149

KAZAJISTÁN

ALMATY - PALATIN

T: +7 (727) 395 78 78 - F: +7 (727) 351 98 98

ALTAMY - STOCK

T: +7 (727) 2758 50 36

ASTANA - PORCELANOSA Associate ASTANA

T: +7 (7172) 28 83 37

KOSOVO

PRISHTINA - N P KERASAN

T: +381 38 602 667 - F: +381 38 602 667

KUWAIT

SAFAT - HASSAN ABUL HASSAN SADIQ

International Showrooms

MOSCOW - ZODIAC
T: +7 (495) 984 28 57
MOSCOW - ZODIAC
T: +7 (495) 223 40 44
MYTISCHI - ZODIAC
T: +7 (495) 221 75 00
MYTISCHI - ZODIAC
T: +7 (495) 975 27 97
NIZHNY NOVGOROD - ZODIAC
T: +7 (831) 216 08 08
NOVOROSIYSK - AGORA
T: +7 (8617) 615 999
NOVOROSIYSK - MOY DOM
T: +7 (383) 223 24 87
PYATIGORSK - SALON BOMOND
T: +7 (8793) 975 544
ROSTOV NA DONU - SALON BOMOND
T: +7 (863) 266 50 34
RYAZAN - SINTI
T: +7 (4912) 46 00 46
ST. PETERSBURG - DOM LAVERNA
T: +7 (812) 329 56 65
ST. PETERSBURG - DOM LAVERNA
T: +7 (812) 327 94 09
ST. PETERSBURG - DOM LAVERNA
T: +7 (812) 7777 030
ST. PETERSBURG - SALON ELITNOY KERAMIKI NOVUS
T: +7 (812) 325 12 45
ST. PETERSBURG - ZODIAC
T: +7 812 994 79 49
STAVROPOL - SALON VALENCIA
T: +7 (8652) 298 151
VLADIVOSTOK - DOM APEX
T: +7 (4232) 300 688
VOLGOGRAD - BOMOND
T: +7 (8442) 944 709

SENEGAL
DAKAR - C.C.S.
T: +221 33 849 04 04 - F: +221 33 823 13 10

SERBIA
BELGRADO - CERAMIC BY PORCEL.
T: +381 11 3343026 - F: +381 11 3343297
NOVI SAD - RACA COMPLETE
T: +381 21 451 534 - F: +381 21 472 0668

SINGAPUR
SINGAPUR - FERNANDO MARTIN BENITO
T: +65 97801472 - F: +65 64621620
SINGAPUR - HAFARY PRIVATE LIMITED
T: +6566047702 - F: +6562534496

SRI LANKA
COLOMBO 13 - RANJANAS CERAMIC
T: +94 11 2543255 - F: +94 11 2381386

SUDÁFRICA
DURBAN - CLASSIC TRADING
T: +27 31 577 8382 - F: +27 31 577 7056
JOHANNESBURG - CLASSIC TRADING
T: +27 11 656 0400 - F: +27 11 656 0403

SUECIA
MÖLNDAL - KAKELPALATZET I MÖLNDAL Headquarters
T: +46 (0)31 776 50 51 - F: +46 (0)31 86 39 62
BROMMA - KAKELPALATZET I BROMA AB
T: +46 (0)8 56 487 831 - F: +46 (0)8-988 620
GÖTEBORG - KAKELPALATZET I BÄCKEBÖL AB
T: +46 (0)31 571 478 - F: +46 (0)31-571 477
KATRINEHÖLM - KAKELPALATZET I KATRINEHÖLM AB
T: +46 (0)8150-51 740 - F: +46 (0)150-51 775
NYKÖPING - KAKELPALATZET I NYKÖPING AB
T: +46 (0)155 200 999 - F: +46 (0)155-211 244
UDDEVALLA - KAKELPALATZET I UDDEVALLA AB
T: +46 (0)522 64 54 00 - F: +46 (0)522-64 54
MALMÖ - KERMA KAKEL AB
T: +46 403 122 40 - F: +46 403 122 59
ENKÖPING - LHADOS KAKEL AB
T: +46 171 478 090 - F: +46 171 478 099
HÄSLEHÖLM - STENMONTÖREN AB
T: +46 451 381 970 - F: +46 451 381 979

SUIZA
AUBONNE - ARGECOM SA
T: +41 (0) 21 807 10 10 - F: +41 (0) 21 808 61 02
ARBON - HAMA KERAMIKDESIGN
T: +41 71 446 61 66 - F: +41 71 446 61 65
BASEL - SABAG SA
T: +41 61 337 83 83 - F: +41 61 337 83 88
BASEL - PORCELANOSA BÄLE
T: +4161 693 00 00
BIEL - SABAG SA
T: +41 32 328 28 28 - F: +41 32 328 28 80
CRISSIER - SABAG SA
T: +41 21 633 06 84 - F: +41 21 633 06 85
GENÈVE - SABAG SA
T: +41 22 908 06 90 - F: +41 22 908 06 95
YVERDON-LES-BAINS - SABAG SA
T: +41 24 423 44 30 - F: +41 24 423 44 45
SEVELÉN - KAISER AG BAD & PLÄTTLI
T: +41 81 785 2242 - F: +41 81 785 2204

VOLKETSWIL - MPV HANDELS AG
T: +41 (0)43 399 53 00 - F: +41 (0)43 399 53 20
DELEMONT - SABAG SA
T: +41 32 4 216 216 - F: +41 32 4 216 214
HÄGENDORF - SABAG SA
T: +41 62 209 09 09 - F: +41 62 209 09 00
ROTHENBURG - SABAG SA
T: +41 41 289 72 72 - F: +41 41 289 72 73
ZÜRICH - SABAG SA
T: +41 44 446 17 17 - F: +41 44 446 17 50
RÜTI B. BÜREN - STEIN & KERAMIK
T: +41 32 351 22 44 - F: +41 32 351 25 90
MENDRISO - NEW FORM SWISS SÄGL
T: +41 91 922 7356

SURINAME
PARAMARIBO - NV RONANS TRADING
T: +597 451070 - F: +597 450066

TAILANDIA
BANGKOK - BOONTHAVORN CERAMIC (RATCHADAPISEK)
T: +66 2 275 0029 - F: +66 2 275 2057
BANGKOK - BOONTHAVORN CERAMIC CO. LTD (PINKLAO)
T: +66 2 441 3075 - F: +66 2 441 4049
BANGKOK - BOONTHAVORN CERAMIC CO. LTD (SUVARNABHUMI)
T: +66 2 316 0429 - F: +66 2 7500682
BANGKOK - BOONTHAVORN CERAMIC CO. LTD (KASET NAVAMIN)
T: +66 2 791 2777 - F: +66 2 943 9058
BANGKOK - BOONTHAVORN CERAMIC CO. LTD (PATTAYA)
T: +66 38 052 222 - F: +66 38 052 221
CHIANGMAI - BOONTHAVORN CERAMIC CO. LTD. (CHIANGMAI)
T: +66 53 105 099 - F: +66 53 105 107
PRACHUABKRIKUN - BOONTHAVORN CERAMIC CO. LTD (HIAHIN)
T: +66 3252-2555// +668-5488-4144 - F: +66 3252 0141
PATHUMTHANEE - BOONTHAVORN CERAMIC CO. LTD (RANGSIT)
T: +66 2 902 0171 - F: +66 2 902 0184
SAMUTSAKON - BOONTHAVORN CERAMIC CO. LTD
(THONBUREE - PAKTHOR)
T: +66 2 896 4471-2 - F: +66 2 896 4473

TAIWÁN
KAOHSIUNG - NEW CENTURY CONSTRUCTIONAL CORP
T: +886 7 384 8834 - F: +886 7 387 1043
TAINAN - NEW CENTURY CONSTRUCTIONAL CORP
T: +886-7-3848834
TAIPEI - NEW CENTURY CONSTRUCTIONAL CORP
T: 73845135
TAICHUNG - NEW CENTURY CONSTRUCTIONAL CORP
T: +886 4 2372 8166 - F: +886 4 2376 2818

TÚNEZ
TÚNEZ - LIFE STYLE
T: +216 71 861 551 - F: +216 71 861 549
TUNIS CEDEX - ABDENNADHER BRICOLAGE CENTER
T: +216 71 725 194 - F: +216 71 760 046
SFAX - ABC ABDENNADHER
T: 74 46 80 72 - F: 74 24 48 85
HAMMAM SOUSSE - ABC ABDENNADHER
T: 73 32 44 24 - F: 73 32 44 25
HAMMAMET - ABC ABDENNADHER
T: 72 26 04 77 - F: 72 26 04 77
GABES - ABC ABDENNADHER
T: 75 29 49 10 - F: 74 24 48 85
MENZEL HAYET - ABC ABDENNADHER
T: 73 41 04 16 - F: 73 41 04 01
SOUSSE - ABC ABDENNADHER
T: 73 37 14 76 - F: 73 37 14 75
TÚNEZ - ABC ABDENNADHER
T: 71 72 58 80 / 71 72 57 77 - F: 71 76 00 46
TURKMENISTAN
ASHGABAD - AK TAY
T: +99312 220134

TURQUÍA
ISTAMBUL - YÜTAS
T: +90 2 1227 44720 - F: +90 2 1227 20874

UCRANIA
KHARKIV - EUROPA
T: (572) 23 59 95
KYIV - SALON MILLENNIUM CONCEPT
T: (044) 279 60 60
LVIV - SALON KARMEN
T: +380 32 244 40 55 - F: +380 32 252 70 94
ODESSA - ITIS GALLERY
T: + 38 (442) 781 910
DONETSK - NAUTILUS
T: 062 387 58 58
DNIPROPETROVSK - EUROPA
T: (0562) 31-27-53

URUGUAY
MONTEVIDEO - ACHER
T: +598 2 487 5630
PUNTA DEL ESTE - ACHER
T: +598 42 248 343 / + 598 42 250 869

UZBEKISTAN
TASHKENT - PREMIUM CONCEPT
T: +998(71) 256 29 05

VENEZUELA
CARACAS - PROSEIN
T: +58 212 239 2911 - F: +58 212 239 9460
CARACAS - PROSEIN EL BOSQUE
T: (+582) 1276 256 01
CARACAS - PROSEIN LA CASTELLANA
T: (+582) 1226 564 19

VIETNAM
HANOI - MILAN ARCHITECTURAL
T: +84 4 3791 3567 - F: +84 4 3791 3568
HANOI - MILAN ARCHITECTURAL
T: +84 432 345 027 - F: +84 432 345 028
HOCHIMINH CITY - MILAN ARCHITECTURAL
T: +84 8 5412 1819 - F: +84 8 5412 1820
HOCHIMINH CITY - CASABELLA CO LTD (HA AN HANH)
T: +84 913237771

YEMEN
SANNA - AL-YAMAMAH GROUP ABO JALAL TAHER
CORPORATION FOR GENERAL TRADE
T: +967 1 470 375 - F: +967 1 405 665

YIBUTI
DJIBOUTI - AL-NEIMA IMMOBILIERE
T: 00253-21356659 - F: 00253-21356289



butech[®]
PORCELANOSA Grupo

butech building technology, s.a.
Ctra. Vila-real - Puebla de Arenoso (CV-20), Km. 2.5 - Apartado de Correos 297 · 12540 Villarreal, Castellón - ESPAÑA.
Teléfono (+34) 964 53 62 00 · Fax: (+34) 964 53 00 34 · E-mail: butech@butech.es · www.butech.es



BY APPOINTMENT TO
H.R.H. THE PRINCE OF WALES
MANUFACTURER AND DISTRIBUTOR
OF CERAMIC TILES AND BUILDING PRODUCTS.
PORCELANOSA GROUP LIMITED

butech[®]
PORCELANOSA Grupo



BY APPOINTMENT TO
H.R.H. THE PRINCE OF WALES
MANUFACTURER AND DISTRIBUTOR
OF CERAMIC TILES AND BUILDING PRODUCTS.
PORCELANOSA GROUP LIMITED

PORCELANOSA Grupo

butech.