

Professional book

products for
tile selection

butech
PORCELANOSA Grupo



Spirit of innovation

BUTECH has invested in the latest technology to develop technical solutions which facilitate the commissioning and delivery of even better designs using PORCELANOSA ceramics.

Over the last few years, BUTECH has introduced innovative installation materials, decorative profiles, shower tray and levelling systems which have become an industry standard. Moreover, BUTECH is a leading company in innovation and development of façade systems for the various cladding materials from Grupo PORCELANOSA: STON-KER, PAR-KER, URBATEK, XLIGHT, XTONE, LINKFLOOR, NATURAL STONE AND KRION.

Trusted professional solutions

BUTECH is part of Grupo PORCELANOSA, a world leader in the design and production of superior quality ceramics. Following on from adhesives and sealing materials for ceramics, BUTECH has evolved to more complex installation systems such as façades and technical flooring.

BUTECH's main aim is to provide PORCELANOSA customers with materials and installation systems which enable successful installation of any type of ceramic flooring or cladding.

BUTECH knows what every kind of ceramics needs and offers technical as well as decorative solutions which allow its installation with total success guarantee.



Index

6
PROFILES AND SKIRTINGS

112
ADHESIVES

136
**GROUTING MATERIAL AND
ELASTIC JOINT SEALANTS**

154
**SUBSTRATE PREPARATION
PRODUCTS**

166
**SHOWER TRAYS AND
WATERPROOFING**

204
MICRO-STUK DESIGN

PROFILES AND SKIRTINGS

LED PROFILES

pro-light 7.5, **10** | pro-light 11, **12** | pro-corner light, **14** | pro-part light, **16**
 pro-telo light, **18** | pro-mate 45 TOP light, **20** | pro-skirting LED, **22**
 COB LED strip, **24** | LED transformer, **24**

DECORATIVE PROFILES

CRYSTAL COLLECTION, **28**

pro-part Li crystal SW galaxy, **28** | pro-part Li crystal rock SW silver, **30**
 pro-part Li crystal sand SW gold, **32** | pro-part Li crystal sand SW silver, **32**
 pro-part crystal SW gold, **34** | pro-part crystal SW silver, **34**

GOLD COLLECTION, **36**

pro-part Li gold, **36** | pro-part gold, **36** | pro-mate 5 gold, **36**

TEXTURE COLLECTION, **38**

pro-part bone, **38** | pro-part coal, **40** | pro-part cast iron, **42**
 pro-part cast copper, **44** | pro-part cement, **46** | pro-part sand, **48**

METAL COLLECTION, **50**

pro-part old iron, **50** | pro-part old bronze, **52** | pro-part rose, **54**
 pro-part rose line, **54** | pro-part moon, **56** | pro-part moon line, **56**
 pro-part ocean, **58** | pro-part ocean line, **58** | pro-part graphite matt, **60**
 pro-part graphite matt line, **60** | pro-part graphite, **62**
 pro-part line, **64** | pro-part line matt, **64**

CHROME COLLECTION, **66**

pro-part chrome, **66** | pro-mate 5 chrome, **66** | pro-mate 3 chrome, **66**

PRO-TELO COLLECTION, **70**

CORNER PROFILES AND TRIMS FOR WALL TILES

pro-mate 2, **74** | pro-mate 3, **75** | pro-mate 5, **76** | pro-part Li, **77**
 pro-part, **78** | pro-mate 45, **80** | pro-corner, **81**
 XLIGHT and XTONE profiles, **82** | 3 metres profiles, **84**

TECHNICAL PROFILES

pro-T, **88** | pro-level, **89** | pro-shower, **90** | pro-sanit, **91**
 pro-dilata, **92** | structural joints, **94** | pro-step, **95**

SKIRTINGS

pro-skirting, **98** | pro-skirting PAR-KER, **100** | pro-plint, **110**





LED PROFILES

LED PROFILES

Decorative profile. Luminescent range for ceramic coverings.

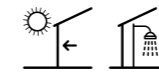

pro-light silver 7.5 mm

pro-light 7.5 mm

Anodized aluminium

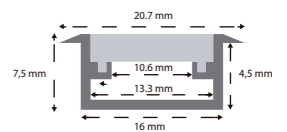

pro-light black
21x7.5x2500 mm

100243703
67.10 p/u



pro-light silver
21x7.5x2500 mm

100243677
67.10 p/u

Lighting system not included. Includes profile, diffuser and corner.

LED PROFILES

Luminescent range for ceramic coverings.



pro-light silver 11 mm

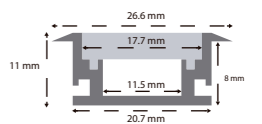

pro-light 11 mm

Anodized aluminium



pro-light silver 11mm
27x11x2500 mm

100202237
69.54 p/u

Lighting system not included. Includes profile, diffuser and corner.

Decorative profile. Luminescent range for ceramic coverings.



pro-corner light

pro-corner light

Anodized aluminium

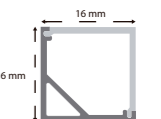

pro-corner light
16x16x2500 mm

100243678
67.10 p/u

Lighting system not included. Includes profile, diffuser and corner.

LED PROFILES

Decorative profile. Luminescent range for ceramic coverings.



pro-part light

pro-part light

Anodized aluminium

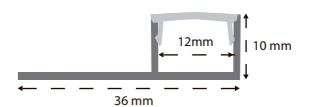

pro-part light
12x10x2500 mm

100243710
148.87 p/u

Lighting system not included. Includes profile, diffuser and corner.

Decorative profile. Luminescent range for ceramic coverings.

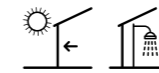

pro-telo light

pro-telo light

Anodized aluminium

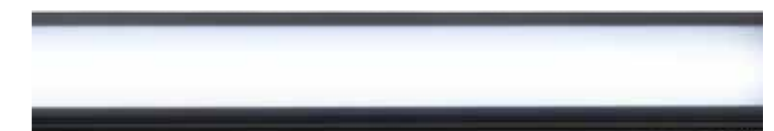
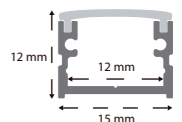

pro-telo light black
15x12x3000 mm

100281601
70.14 p/u



pro-telo light silver
15x12x3000 mm

100281600
62.73 p/u

Lighting system not included. Includes profile, diffuser and corner.

LED PROFILES

Decorative profile. Luminescent range for ceramic coverings.



pro-mate 45 TOP light

pro-mate 45 TOP light

Anodized aluminium

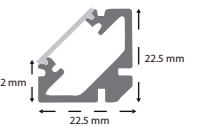

pro-mate 45 TOP light
22.5x22.5x2500 mm

100243649
77.30 p/u

Lighting system not included. Includes profile, diffuser and corner.

Decorative profile. Luminescent range for ceramic coverings.

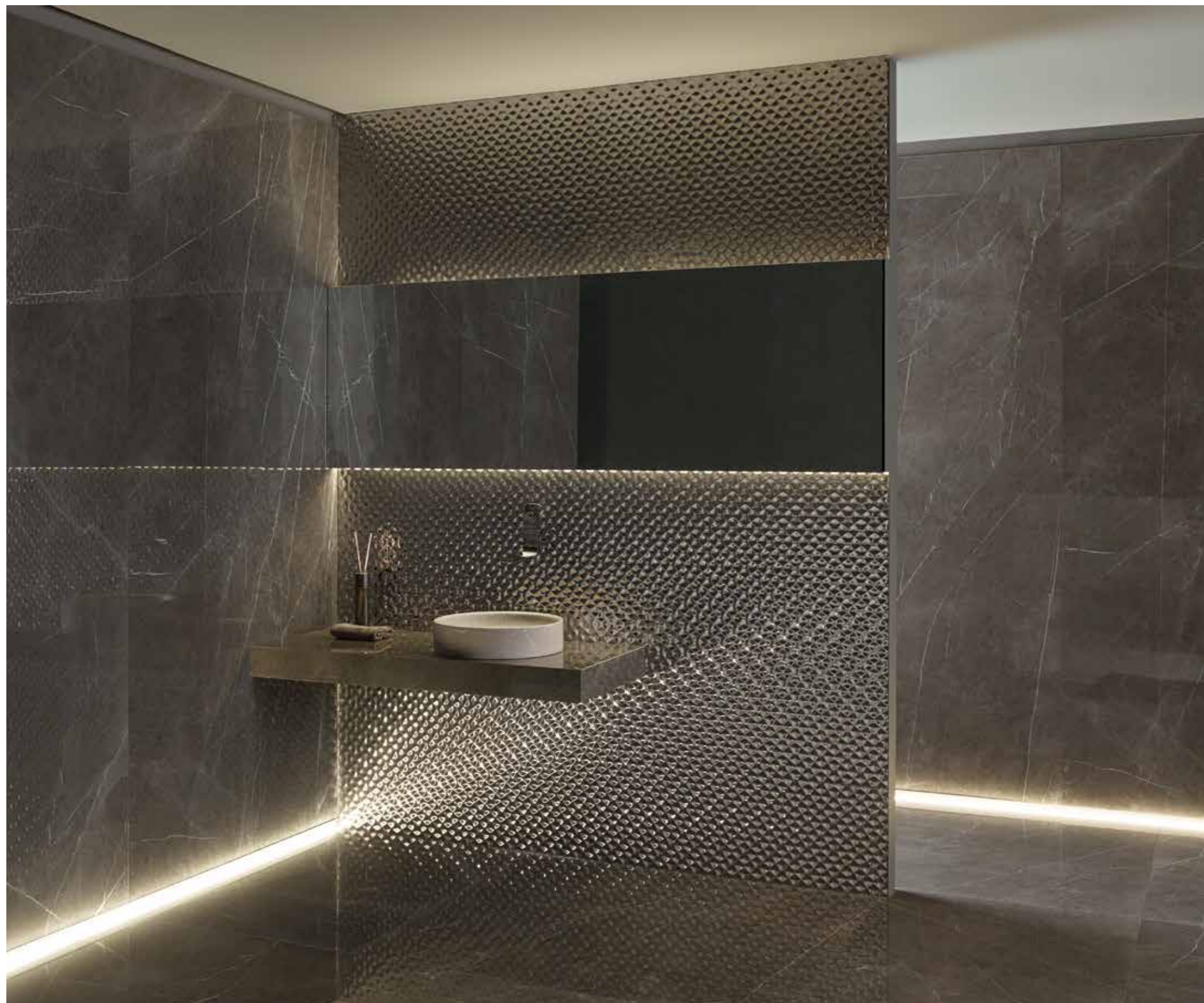
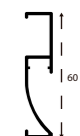

pro-skirting LED white

pro-skirting LED

Anodized aluminium



pro-skirting LED black 13x60x2500 mm	100200414 28.77 p/u
pro-skirting LED corner black 13x60x5 mm	100213201 10.52 p/u



pro-skirting LED white 13x60x2500 mm	100200418 27.16 p/u
pro-skirting LED corner white 13x60x5 mm	100213220 10.52 p/u



pro-skirting LED silver 13x60x2500 mm	100200403 28.77 p/u
pro-skirting LED corner silver 13x60x5 mm	100213154 10.52 p/u

Diffuser and lighting system not included.
Caps are supplied separately.

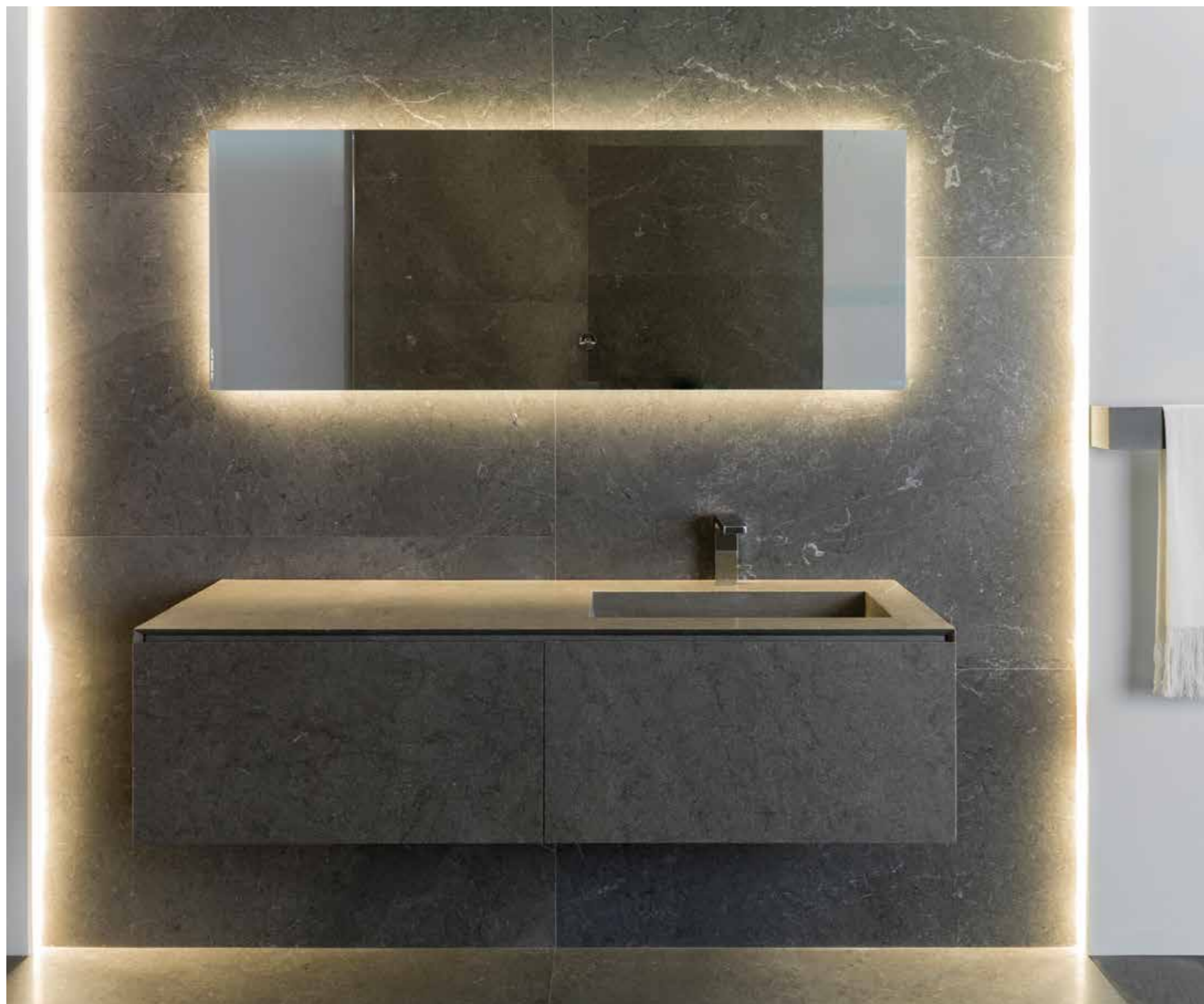

pro-light silver 11 mm

COB LED strip

Linear lighting system for profiles from the pro-light collection.

COB LED luminaires are packages of multiple LEDs that are joined together into a single lighting module. In practice, only one point of light is seen, but with a higher light output. That is, with the same power as an SMD, more lumens / watt are achieved.

COB LED strip IP20

COB LED strip IP20 3000°K 2x10x2500 mm	100298585 87.62 p/u
COB LED strip IP20 4000°K 2x10x2500 mm	100298526 87.62 p/u
COB LED strip IP20 6500°K 2x10x2500 mm	100298597 87.62 p/u

Power	15 W/m	Lumens 3.000°K	1400 Lm/m*
Voltage	24 V	Lumens 4.000°K	1500 Lm/m*
N° chips/m	480	Lumens 6.500°K	1530 Lm/m*
PCB	10 mm	Light emission	180°

IP20: For use in dry environments. Interior flooring and coverings.

COB LED strip IP67

COB LED strip IP67 3000°K 4,6x11,6x2500 mm	100298620 112.99 p/u
COB LED strip IP67 4000°K 4,6x11,6x2500 mm	100298587 112.99 p/u
COB LED strip IP67 6500°K 4,6x11,6x2500 mm	100298621 112.99 p/u

Power	15 W/m	Lumens 3.000°K	1205 Lm/m*
Voltage	24 V	Lumens 4.000°K	1216 Lm/m*
N° chips/m	480	Lumens 6.500°K	1210 Lm/m*
PCB	11,6 mm	Light emission	180°

IP67: For use in wet environments. Interior flooring and coverings and exterior coverings.

LED transformer

Transf. pro-light 100W 24V 0-5 mts 190x52x39 mm	100200310 91.22 p/u
---	-------------------------------

Power	100 W
Voltage	24 V
Electric current	4.2 A
Maximum length of led strip	5 m

* The light output (Lumens) of COB LED strips may vary slightly from one strip to another.



CRYSTAL COLLECTION

High-end decorative profile for ceramic wall tiling, made with Swarovski crystals.
Replaces the traditional decorative ceramic listellos by new design metallic lines.



pro-part Li crystal SW galaxy

Not recommended for walls in direct contact with water.

pro-part Li crystal SW galaxy

Chromed brass profile. Made with Swarovski Elements



pro-part Li crystal galaxy 11 mm
12x11x2500 mm

100171653
411.00 p/u

CRYSTAL COLLECTION

High-end decorative profile for ceramic wall tiling, made with Swarovski crystals.
Replaces the traditional decorative ceramic listellos by new design metallic lines.



pro-part Li crystal rock SW silver

Not recommended for walls in direct contact with water.

pro-part Li crystal rock SW silver

Chromed brass profile. Made with Swarovski Elements



pro-part Li Crystal rock SW silver 11mm
12x11x2500 mm

100130429
489.46 p/u

CRYSTAL COLLECTION

High-end decorative profile for ceramic wall tiling, made with Swarovski crystals.
Replaces the traditional decorative ceramic listellos by new design metallic lines.



pro-part Li Crystal sand SW silver

Not recommended for walls in direct contact with water.

pro-part Li Crystal sand SW Gold

24 k Gold plated. Made with Swarovski Elements



pro-part Li crystal sand SW Gold 11mm
12x11x2500 mm

100130430
400.06 p/u

pro-part Li Crystal sand SW Silver

Chromed brass profile. Made with Swarovski Elements



pro-part Li crystal sand SW silver 11mm
12x11x2500 mm

100130431
341.05 p/u

CRYSTAL COLLECTION

High-end decorative profile for ceramic wall tiling, made with Swarovski crystals.
Replaces the traditional decorative ceramic listellos by new design metallic lines.



pro-part crystal SW gold

24 k Gold plated. Made with Swarovski Elements



pro-part crystal SW gold 11mm
8x11x2500 mm

100155354
702.28 p/u

pro-part crystal SW silver

Chromed brass profile. Made with Swarovski Elements



pro-part crystal SW silver 11mm
8x11x2500 mm

100155356
577.96 p/u

pro-part crystal SW silver

Not recommended for walls in direct contact with water.

GOLD COLLECTION

High-end decorative profile for wall tiles, 24K Gold plated.
It substitutes the traditional ceramic frieze by a metallic line with an exclusive design.

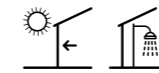

pro-part gold

pro-part Li gold

24 carat Gold plated profile. 12 and 13,5 mm decorative trim.



pro-part Li gold 12,5mm 100100762
13,5x12,5x2500 mm **129.42** p/u

pro-part Li gold 11mm 100100726
12x11x2500 mm **124.54** p/u

pro-part gold

24 carat Gold plated profile. 8 mm decorative trim.



pro-part gold 12.5mm 100100725
8x12,5x2500 mm **119.25** p/u

pro-part gold 11mm 100100724
8x11x2500 mm **110.93** p/u

pro-part gold 7mm 100246452
8x7x2500 mm **121.86** p/u

pro-mate 5 gold

24 carat Gold plated profile. 5 mm decorative trim.



pro-mate 5 gold 12.5mm 100100722
5x12,5x2500 mm **104.86** p/u

pro-mate 5 gold 11mm 100100721
5x11x2500 m **103.52** p/u

Matte metallic finish decorative profiles for ceramic wall tiles. It substitutes the traditional ceramic frieze.



pro-part bone

Brass profile with matte metallic covering. 8 mm decorative trim.



pro-part bone 7mm 8x7x2500 mm	100278708 72.52 p/u
pro-part bone 11mm 8x11x2500 mm	100269007 75.01 p/u
pro-part bone 12,5mm 8x12,5x2500 mm	100278730 76.34 p/u

Matte metallic finish decorative profiles for ceramic wall tiles. It substitutes the traditional ceramic frieze.



pro-part coal

pro-part coal

Brass profile with matte metallic covering. 8 mm decorative trim.



pro-part coal 7mm 8x7x2500 mm	100278697 72.52 p/u
pro-part coal 11mm 8x11x2500 mm	100269081 75.01 p/u
pro-part coal 12,5mm 8x12,5x2500 mm	100278751 76.34 p/u

Matte metallic finish decorative profiles for ceramic wall tiles. It substitutes the traditional ceramic frieze.



pro-part cast iron

Brass profile with matte metallic covering. 8 mm decorative trim.



pro-part cast iron 11mm 8x11x2500 mm	100222994 75.01 p/u
pro-part cast iron 12,5mm 8x12,5x2500 mm	100278717 76.34 p/u

Matte metallic finish decorative profiles for ceramic wall tiles. It substitutes the traditional ceramic frieze.



pro-part cast copper

pro-part cast copper

Brass profile with matte metallic covering. 8 mm decorative trim.



pro-part cast copper 11mm
8x11x2500 mm

100223015
75.01 p/u

Matte metallic finish decorative profiles for ceramic wall tiles. It substitutes the traditional ceramic frieze.



pro-part cement

Brass profile with matte metallic covering. 8 mm decorative trim.



pro-part cement 11mm
8x11x2500 mm

100226161
75.01 p/u

Matte metallic finish decorative profiles for ceramic wall tiles. It substitutes the traditional ceramic frieze.



pro-part sand

pro-part sand

Brass profile with matte metallic covering. 8 mm decorative trim.



pro-part sand 11mm
8x11x2500 mm

100226152
75.01 p/u

METAL COLLECTION

Metallic finish decorative profiles for ceramic wall tiles. It substitutes the traditional ceramic frieze.

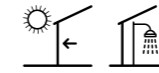

pro-part old iron

pro-part old iron

Brass profile with metallic covering. 8 mm decorative trim.



pro-part old iron 11mm
8x11x2500mm

100189093
91.12 p/u

METAL COLLECTION

Metallic finish decorative profiles for ceramic wall tiles. It substitutes the traditional ceramic frieze.

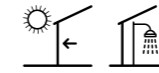

pro-part old bronze

pro-part old bronze

Brass profile with metallic covering. 8 mm decorative trim.



pro-part old bronze 7mm 8x7x2500mm	100278752 96.47 p/u
pro-part old bronze 11mm 8x11x2500mm	100189092 92.91 p/u
pro-part old bronze 12,5mm 8x12,5x2500mm	100243964 97.20 p/u

Matte metallic finish decorative profiles for ceramic wall tiles. It substitutes the traditional ceramic frieze.

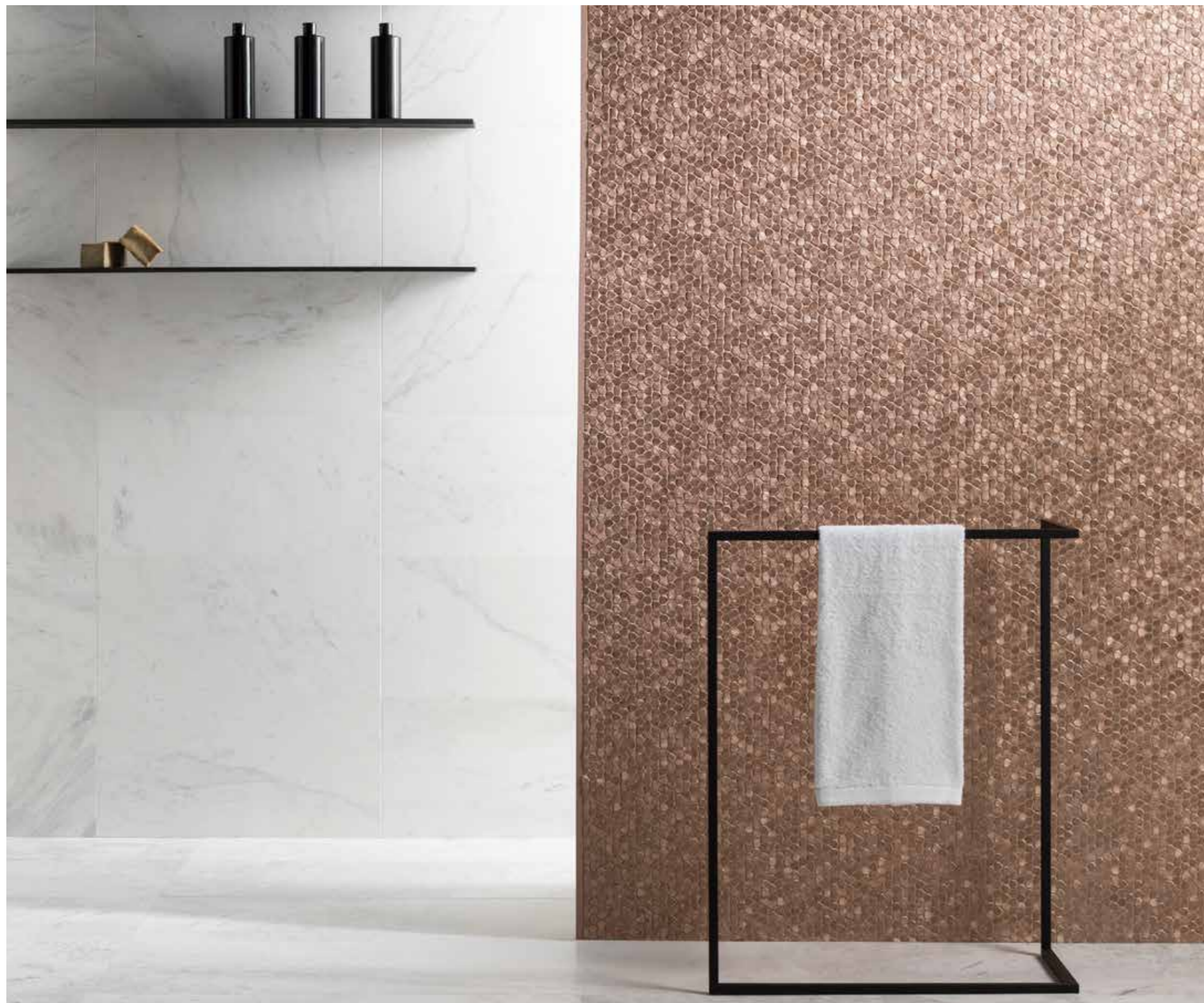
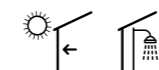

pro-part rose line

pro-part rose

Brass profile with matte metallic covering. 8 mm decorative trim.



Shade 1

pro-part rose 7mm	100232244
8x7x2500 mm	122.61 p/u
pro-part rose 11mm	100231592
8x11x2500 mm	113.96 p/u
pro-part rose 12,5mm	100278753
8x12,5x2500 mm	126.94 p/u

Shade 2

pro-part rose 7mm	100297853
8x7x2500 mm	122.61 p/u
pro-part rose 11mm	100297848
8x11x2500 mm	113.96 p/u
pro-part rose 12,5mm	100297612
8x12,5x2500 mm	126.94 p/u

pro-part rose line

Brass profile with matte metallic covering. 8 mm decorative trim.



Shade 1

pro-part rose line 7mm	100232236
8x7x2500 mm	124.25 p/u
pro-part rose line 11mm	100231584
8x11x2500 mm	115.84 p/u
pro-part rose line 12,5mm	100278736
8x12,5x2500 mm	126.07 p/u

Shade 2

pro-part rose line 7mm	100297828
8x7x2500 mm	124.25 p/u
pro-part rose line 11mm	100297854
8x11x2500 mm	115.84 p/u
pro-part rose line 12,5mm	100297585
8x12,5x2500 mm	126.07 p/u

Metallic finish decorative profiles for ceramic wall tiles. It substitutes the traditional ceramic frieze.

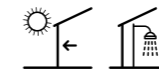

pro-part moon line

pro-part moon

Brass profile with metallic covering. 8 mm decorative trim.



Shade 1

pro-part moon 7mm 8x7x2500m	100177056 83.69 p/u
pro-part moon 11m 8x11x2500mm	100120369 90.02 p/u
pro-part moon 12,5mm 8x12,5x2500mm	100177071 87.67 p/u

Shade 2

pro-part moon 7mm 8x7x2500m	100297628 83.69 p/u
pro-part moon 11m 8x11x2500mm	100297599 90.02 p/u
pro-part moon 12,5mm 8x12,5x2500mm	100297691 87.67 p/u

pro-part moon line

Brass profile with metallic covering. 8 mm decorative trim.



Shade 1

pro-part moon line 7mm 8x7x2500mm	100177063 85.53 p/u
pro-part moon line 11mm 8x11x2500mm	100158267 89.52 p/u
pro-part moon line 12,5mm 8x12,5x2500mm	100177080 87.67 p/u

Shade 2

pro-part moon line 7mm 8x7x2500mm	100297638 85.53 p/u
pro-part moon line 11mm 8x11x2500mm	100297641 89.52 p/u
pro-part moon line 12,5mm 8x12,5x2500mm	100297597 87.67 p/u

Metallic finish decorative profiles for ceramic wall tiles. It substitutes the traditional ceramic frieze.

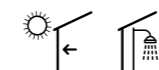

pro-part ocean

pro-part ocean

Brass profile with metallic covering. 8 mm decorative trim.



Shade 1

pro-part ocean 7mm 8x7x2500mm	100177070 83.69 p/u
pro-part ocean 11mm 8x11x2500mm	100120370 87.48 p/u
pro-part ocean 12,5mm 8x12,5x2500mm	100177072 85.25 p/u

Shade 2

pro-part ocean 7mm 8x7x2500mm	100297965 83.69 p/u
pro-part ocean 11mm 8x11x2500mm	100297983 87.48 p/u
pro-part ocean 12,5mm 8x12,5x2500mm	100297964 85.25 p/u

pro-part ocean line

Brass profile with metallic covering. 8 mm decorative trim.



Shade 1

pro-part ocean line 7mm 8x7x2500mm	100177064 85.53 p/u
pro-part ocean line 11mm 8x11x2500mm	100158268 92.98 p/u
pro-part ocean line 12,5mm 8x12,5x2500mm	100177034 87.67 p/u

Shade 2

pro-part ocean line 7mm 8x7x2500mm	100297994 85.53 p/u
pro-part ocean line 11mm 8x11x2500mm	100298004 92.98 p/u
pro-part ocean line 12,5mm 8x12,5x2500mm	100297976 87.67 p/u

Metallic finish decorative profiles for ceramic wall tiles. It substitutes the traditional ceramic frieze.

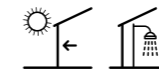

pro-part graphite matt line

pro-part graphite matt

Brass profile with metallic covering. 8 mm decorative trim.



Shade 1

pro-part graphite matt 7mm 8x7x2500 mm	100177037 90.24 p/u
pro-part graphite matt 11mm 8x11x2500 mm	100158266 91.98 p/u
pro-part graphite matt 12,5mm 8x12,5x2500 mm	100177053 89.59 p/u

Shade 2

pro-part graphite matt 7mm 8x7x2500 mm	100297570 90.24 p/u
pro-part graphite matt 11mm 8x11x2500 mm	100297543 91.98 p/u
pro-part graphite matt 12,5mm 8x12,5x2500 mm	100297607 89.59 p/u

pro-part graphite matt line

Brass profile with metallic covering. 8 mm decorative trim.



Shade 1

pro-part graphite matt line 7mm 8x7x2500 mm	100177055 90.24 p/u
pro-part graphite matt line 11mm 8x11x2500 mm	100158265 95.55 p/u
pro-part graphite matt line 12,5mm 8x12,5x2500 mm	100177036 98.91 p/u

Shade 2

pro-part graphite matt line 7mm 8x7x2500 mm	100297545 90.24 p/u
pro-part graphite matt line 11mm 8x11x2500 mm	100297539 95.55 p/u
pro-part graphite matt line 12,5mm 8x12,5x2500 mm	100297684 98.91 p/u

Metallic finish decorative profiles for ceramic wall tiles. It substitutes the traditional ceramic frieze.

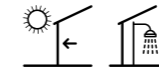

pro-part graphite

pro-part graphite

Brass profile with metallic covering. 8 mm decorative trim.



Shade 1

pro-part graphite 7mm 8x7x2500 mm	100177049 86.72 p/u
pro-part graphite 11mm 8x11x2500 mm	100120366 93.00 p/u
pro-part graphite 12,5mm 8x12,5x2500 mm	100177035 96.07 p/u

Shade 2

pro-part graphite 7mm 8x7x2500 mm	100297518 86.72 p/u
pro-part graphite 11mm 8x11x2500 mm	100297555 93.00 p/u
pro-part graphite 12,5mm 8x12,5x2500 mm	100297528 96.07 p/u

Metallic finish decorative profiles for ceramic wall tiles. It substitutes the traditional ceramic frieze.



pro-part line

pro-part line

Brass profile with metallic covering. 8 mm decorative trim.



pro-part line 7mm 8x7x2500 mm	100177061 79.84 p/u
pro-part line 11mm 8x11x2500 mm	100120367 85.12 p/u
pro-part line 12,5mm 8x12,5x2500 mm	100177058 87.67 p/u

pro-part line matt

Brass profile with metallic covering. 8 mm decorative trim.



pro-part line matt 7mm 8x7x2500 mm	100177062 79.84 p/u
pro-part line matt 11mm 8x11x2500 mm	100157798 85.12 p/u
pro-part line matt 12,5mm 8x12,5x2500 mm	100177059 83.49 p/u

CHROME COLLECTION

Chromed brass decorative profile for wall tiles. It substitutes the traditional decorative ceramic frieze.
 Typical LIFESTYLE by PROCELANOSA profile.



pro-part chrome



pro-part chrome 9 mm 8x9x2500 mm	100005369 75.20 p/u
pro-part chrome 10 mm 8x10x2500 mm	100088905 76.39 p/u
pro-part chrome 11 mm 8x11x2500 mm	100005370 78.05 p/u

pro-mate 5 chrome



pro-mate 5 chrome 9mm 5x9x2500 mm	100004945 67.42 p/u
pro-mate 5 chrome 11mm 5x11x2500 mm	100004946 69.89 p/u
pro-mate 5 chrome 12,5mm 5x12,5x2500 mm	100004955 72.35 p/u

pro-mate 3 chrome



pro-mate 3 chrome 9mm 3x9x2500 mm	100004952 59.37 p/u
pro-mate 3 chrome 10mm 3x10x2500 mm	100004953 60.09 p/u
pro-mate 3 chrome 12,5mm 3x12.5x2500 mm	100004954 61.54 p/u

pro-part chrome

CHROME COLLECTION

Chromed brass decorative profile for wall tiles. It substitutes the traditional decorative ceramic frieze.
Typical LIFESTYLE by PROCELANOSA profile.

Suitable for trimming corners and transitions between ceramic tiles.

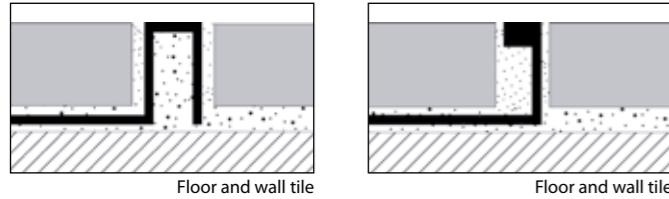

pro-part



Chromed brass			Chromed brass corner		
SAP	h (mm)	P/EU	SAP	h (mm)	P/EU
100005368	7	72.35 p/u	100005373	7	26.30 p/u
100177061	Line	79.84 p/u	100005374	9	26.30 p/u
100177062	Line matt	79.84 p/u	100091065	10	25.58 p/u
100005369	9	75.20 p/u	100005375	11	26.30 p/u
100088905	10	76.39 p/u	100005376	12,5	26.30 p/u
100005370	11	78.05 p/u			
100120367	Line	85.12 p/u			
100157798	Line matt	85.12 p/u			
100005371	12,5	80.54 p/u			
100177058	Line	87.67 p/u			
100177059	Line matt	83.49 p/u			

pro-mate 5

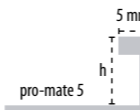

Chromed brass		
SAP	h (mm)	P/EU
100126779	7	65.74 p/u
100004945	9	67.42 p/u
100004946	11	69.89 p/u
100004955	12,5	72.35 p/u

pro-mate 3

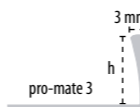

Chromed brass		
SAP	h (mm)	P/EU
100126772	6	58.67 p/u
100004951	8	60.44 p/u
100004952	9	59.37 p/u
100004953	10	60.09 p/u
100004954	12,5	61.54 p/u



pro-part Li



Chromed brass			Chromed brass corner			
SAP	h (mm)	a (mm)	P/EU	SAP	h (mm)	P/EU
100126780	4,5	5,5	89.62 p/u	100098464	11	26.89 p/u
100070170	11	12	86.50 p/u	100085153	12,5	29.52 p/u
100070171	12,5	13,5	91.11 p/u			

pro-mate 45 TOP

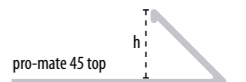
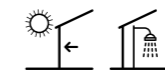

Chromed brass		
SAP	h (mm)	P/EU
100126778	6	66.06 p/u
100099965	10	65.87 p/u
100128801	12,5	81.86 p/u

pro-mate 45

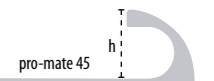

Chromed brass		
SAP	h (mm)	P/EU
100126776	6	67.77 p/u
100099963	10	76.48 p/u
100099964	12,5	81.74 p/u

PRO-TELO COLLECTION

Metal decorative profile for ceramic wall tiles. Flangeless metallic line for tiles of any thickness.

Available in a wide variety of materials, finishes and dimensions, they represent an excellent solution for the design of contemporary style ceramic settings.

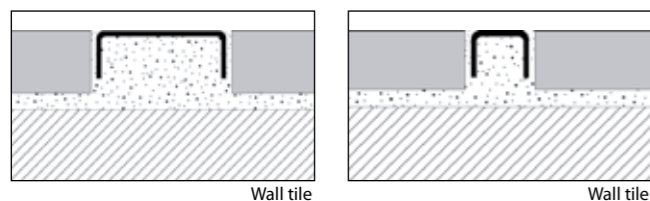

pro-telo stainless 8x40

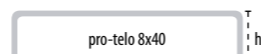

Stainless Steel 8x40

SAP	Finish	h (mm)	P/EU
100005299	Gloss	8	78.27 p/u

pro-telo stainless 8x25

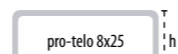

Stainless Steel 8x25

SAP	Finish	h (mm)	P/EU
100005293	Gloss	8	41.60 p/u

pro-telo aluminium

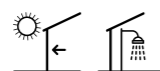

Aluminium 8x10 silver

SAP	Finish	h (mm)	P/EU
100005289	Gloss	10	28.41 p/u
100005286	Anodized	10	18.07 p/u

pro-telo recto

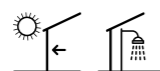

Aluminium 8x10

SAP	Finish	h (mm)	P/EU
100084015	High gloss	8	20.77 p/u





CORNER PROFILES AND TRIMS FOR WALL TILES

pro-mate 2

Right angle, stainless steel profile for corners and wall and floor tile coverings.

Right angle, stainless steel profiles for trimming the non-glazed edge of the tile. Suitable for separating tiles in walls as well as in floors.

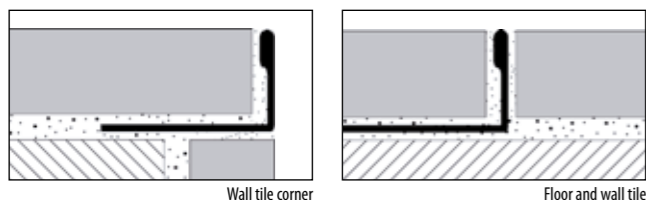

pro-mate 2

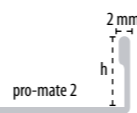

V2A Stainless steel

SAP	h (mm)	P/EU
100126769	6	26.62 p/u
100004957	10	26.95 p/u
100004958	12,5	27.88 p/u
100004959	15	40.58 p/u
100004960	20	42.86 p/u

V2A Gloss stainless steel

SAP	h (mm)	P/EU
100004967	10	34.22 p/u
100004968	12,5	41.48 p/u
100004969	15	50.09 p/u

V4A Stainless steel

SAP	h (mm)	P/EU
100004964	10	29.72 p/u
100004965	12,5	33.31 p/u

pro-mate 3

Right angle profile for corners and wall and floor tile coverings. Decorative use as a metallic line.

Right angle, 3 mm thick profiles for trimming the non-glazed edge of the tile. Available in a wide variety of materials, they are also suitable for separating wall tiles.

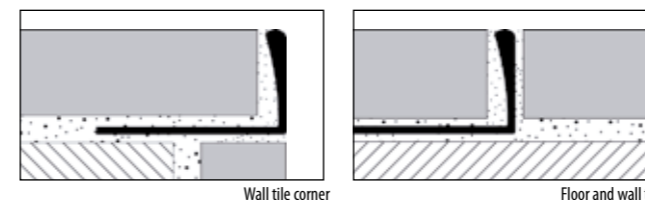

pro-mate 3

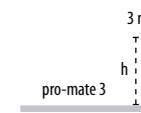

Chromed brass

SAP	h (mm)	P/EU
100126772	6	58.67 p/u
100004951	8	60.44 p/u
100004952	9	59.37 p/u
100004953	10	60.09 p/u
100004954	12,5	61.54 p/u

pro-mate 3

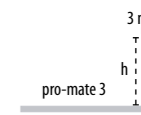

Anodized aluminium silver

SAP	h (mm)	P/EU
100126770	6	18.57 p/u
100004899	8	10.60 p/u
100004900	9	11.48 p/u
100004901	10	11.15 p/u
100200608	11	12.19 p/u
100004902	12,5	11.96 p/u
100004903	15	13.61 p/u

pro-mate 3

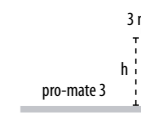
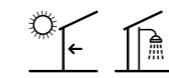

Lacquered aluminium

SAP	h (mm)	P/EU
100126771	6	16.71 p/u
100004911	10	16.35 p/u
100004912	12,5	17.81 p/u
100004915	10	16.35 p/u
100004916	12,5	17.81 p/u
100004919	10	16.35 p/u
100004920	12,5	17.81 p/u

High gloss aluminium

SAP	h (mm)	P/EU
100289643	8	11.92 p/u
100004925	10	23.00 p/u
100004926	12,5	23.69 p/u

PVC

SAP	h (mm)	P/EU
100004865	10	4.78 p/u
100004873	12,5	5.15 p/u
100004866	10	4.78 p/u
100004867	10	4.78 p/u
100004868	10	4.78 p/u
100004869	10	4.78 p/u
100004870	10	4.78 p/u

Black aluminium

SAP	h (mm)	P/EU
100220142	8	24.26 p/u
100171991	10	25.04 p/u
100220132	12,5	25.01 p/u

pro-mate 5

Right angle profile for corners and wall and floor tile coverings. Decorative use as a metallic line.

Right angle and 5 mm edge profiles for trimming the non-glazed edge of the tile. Suitable for transitions between floor coverings at the same level.

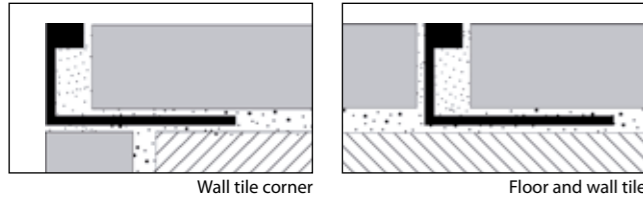

pro-mate 5

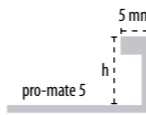

Chromed brass

SAP	h (mm)	P/EU
100126779	7	65.74 p/u
100004945	9	67.42 p/u
100004946	11	69.89 p/u
100004955	12,5	72.35 p/u

pro-mate 5

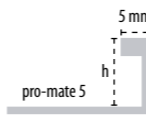

Anodized aluminium silver

SAP	h (mm)	P/EU
100004927	11	17.83 p/u

pro-mate 5

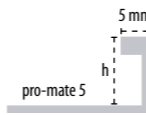
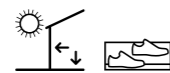

Gloss polished brass

SAP	h (mm)	P/EU
100004944	11	50.86 p/u

pro-part Li

Decorative profile for ceramic wall tiles. Suitable for trimming corners and transitions between ceramic tiles.

Right angle, corner shaped profiles, with both sides of the same length. Specially recommended for rectified tiles corners and for tiles with relief decoration.

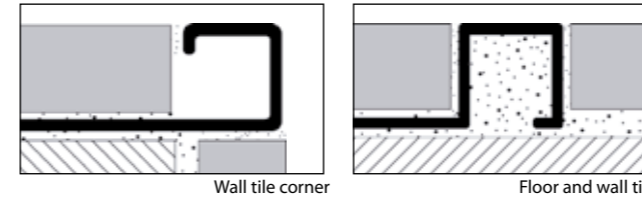

pro-part Li

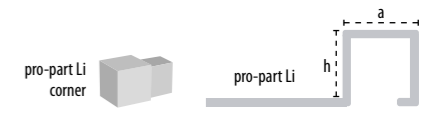

Chromed brass **Chromed brass corner**

SAP	h (mm)	a (mm)	P/EU
100126780	4,5	5,5	89.62 p/u
100070170	11	12	86.50 p/u
100070171	12,5	13,5	91.11 p/u

SAP	h (mm)	P/EU
100098464	11	26.89 p/u
100085153	12,5	29.52 p/u

pro-part Li

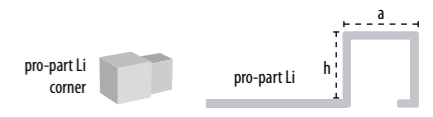
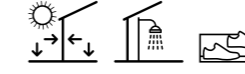

Anodized aluminium silver **Anodized aluminium silver corner**

SAP	h (mm)	a (mm)	P/EU
100128227	4,5	5,5	18.16 p/u
100062074	11	12	20.98 p/u
100062086	12,5	13,5	22.96 p/u

SAP	h (mm)	P/EU
100093706	11	24.70 p/u
100093705	12,5	24.70 p/u

pro-part Li

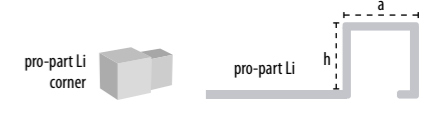
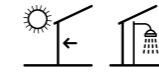

High gloss aluminium **High gloss aluminium**

SAP	h (mm)	a (mm)	P/EU
100062072	11	10	43.18 p/u
100062073	12,5	11,5	46.45 p/u

SAP	h (mm)	P/EU
100102763	11	11.10 p/u
100102762	12,5	13.50 p/u

pro-part Li brushed

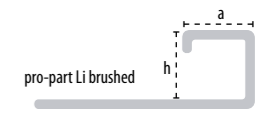

Brushed anodized aluminium

SAP	h (mm)	a (mm)	P/EU
100159084	11	12	47.87 p/u
100159083	12,5	13,5	45.86 p/u

pro-part

Decorative profile for ceramic wall tiles. Suitable for trimming corners and transitions between ceramic tiles.

Right angle, corner shaped profiles, with an 8 mm edge and a variable width edge. Excellent solution for a wide variety of ceramic installations.

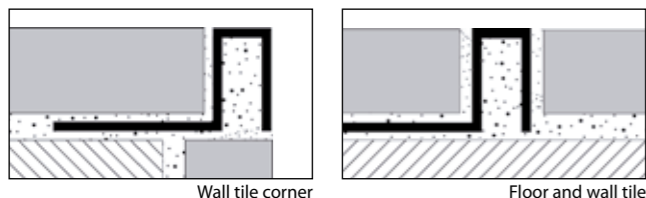

pro-part

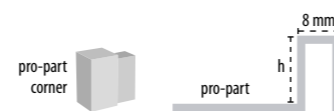

Chromed brass			Chromed brass corner		
SAP	h (mm)	P/EU	SAP	h (mm)	P/EU
100005368	7	72.35 p/u	100005373	7	26.30 p/u
100005369	9	75.20 p/u	100005374	9	26.30 p/u
100088905	10	76.39 p/u	100091065	10	25.58 p/u
100005370	11	78.05 p/u	100005375	11	26.30 p/u
100005371	12,5	80.54 p/u	100005376	12,5	26.30 p/u

pro-part



Anodized aluminium silver			Anodized aluminium silver corner		
SAP	h (mm)	P/EU	SAP	h (mm)	P/EU
100005322	7	14.90 p/u	100005336	7	20.10 p/u
100005323	9	15.70 p/u	100005337	9	20.10 p/u
100005324	11	16.49 p/u	100005338	11	20.10 p/u
100005325	12,5	18.09 p/u	100005339	12,5	20.10 p/u
100005326	15	21.88 p/u			

pro-part

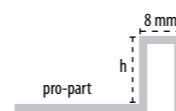
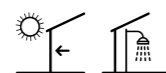

Lacquered aluminium			White matt aluminium		
SAP	h (mm)	P/EU	SAP	h (mm)	P/EU
100088551	Black 11	27.11 p/u	100296752	11	27.11 p/u
100080530	Black 12,5	28.09 p/u	100286598	12,5	28.09 p/u
100100723	White 11	27.11 p/u			
100083438	White 12,5	28.09 p/u			

High gloss aluminium			Black matt aluminium			
KEA	SAP	h (mm)	P/EU	SAP	h (mm)	P/EU
	100089004	11	54.69 p/u	100220100	7	27.48 p/u
	100005353	12,5	54.69 p/u	100171975	11	28.34 p/u
				100220083	12,5	29.19 p/u



pro-part

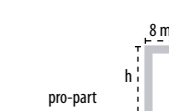
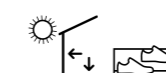

Gloss polished brass		
SAP	h (mm)	P/EU
100005363	11	61.81 p/u
100005364	12,5	63.82 p/u

pro-part



Stainless steel			Stainless steel corner		
SAP	h (mm)	P/EU	SAP	h (mm)	P/EU
100005377	9	34.27 p/u	100005380	9	25.25 p/u
100005378	11	36.68 p/u	100005381	11	25.25 p/u
100005379	12,5	40.88 p/u	100005382	12,5	27.27 p/u

pro-mate 45

Rounded profile for protecting wall tiles corners.

These profiles are the classic solution for protecting corners in wall tile coverings. Available in a wide variety of materials, its main feature is being shock-resistant.

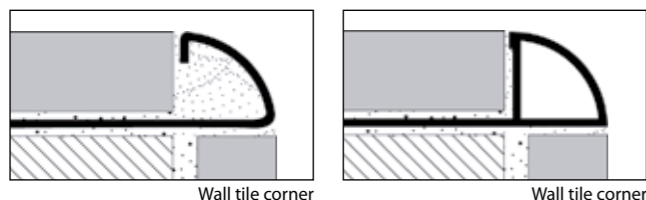

pro-mate 45 Top

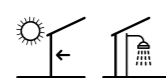

Chromed brass		
SAP	h (mm)	P/EU
100126778	6	66.06 p/u
100099965	10	65.87 p/u
100128801	12,5	81.86 p/u

Anodized aluminium silver		
SAP	h (mm)	P/EU
100126777	6	20.98 p/u

pro-mate 45 brass

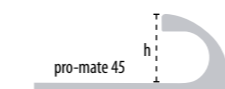
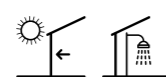

Chromed brass		
SAP	h (mm)	P/EU
100126776	6	67.77 p/u
100099963	10	76.48 p/u
100099964	12,5	81.74 p/u

pro-mate 45 stainless steel

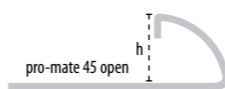
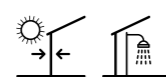

Stainless steel V2A		
SAP	h (mm)	P/EU
100005156	8	33.45 p/u
100005157	10	74.38 p/u
100005158	12,5	38.64 p/u

pro-mate 45 aluminio

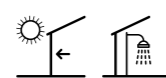

Anodized aluminium silver		
SAP	h (mm)	P/EU
100005094	10	14.34 p/u
100005096	12,5	15.79 p/u

Lacquered aluminium		
SAP	h (mm)	P/EU
100005113	White 10	16.39 p/u
100005117	White 12,5	17.76 p/u

High gloss aluminium		
SAP	h (mm)	P/EU
100096222	10	26.11 p/u
100100665	12,5	27.32 p/u

pro-corner

Metallic profile for protecting corners.

Right angle, metallic profiles for protecting corners. Most of the pro-corner models are installed after the tile, which implies a small lip over the tile surface.

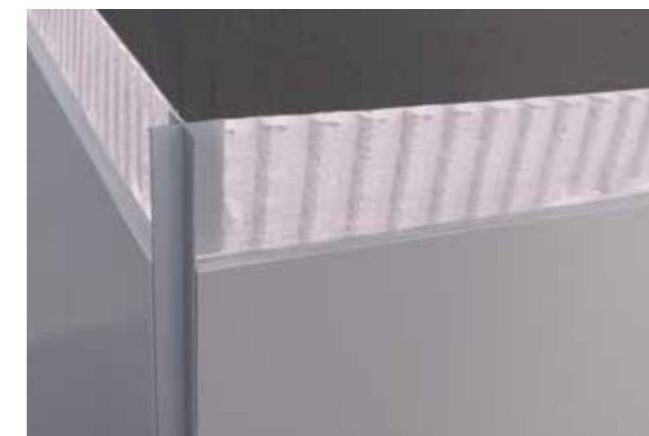
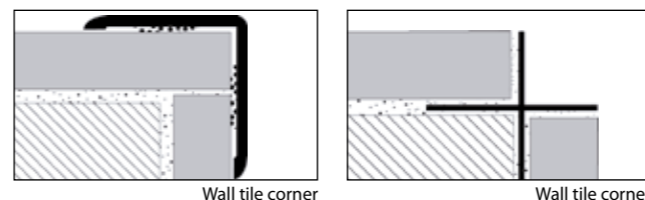

pro-corner P

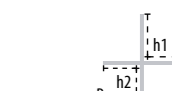
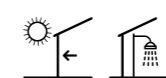

Aluminium				
SAP		h1 (mm)	h2 (mm)	P/EU
100158001	High gloss	15	12	83.16 p/u
100158002	Silver	15	12	73.40 p/u
100213125	Black	15	12	74.38 p/u

pro-corner R

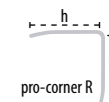
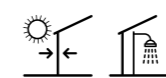

Gloss stainless steel		
SAP	h (mm)	P/EU
100005623	25	59.75 p/u

pro-corner B

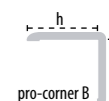
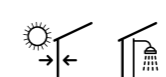

Aluminium		
SAP	h (mm)	P/EU
100005584	25	25.17 p/u

XTONE and XLIGHT profiles

Corner profiles for wall tiles less than 7 mm thick. Specially recommended for mosaics and large format and thin ceramic slabs, such as XTONE and XLIGHT.

Available in different shapes, from right-angled profiles for straight trims to rounded shape profiles. Decorative use.

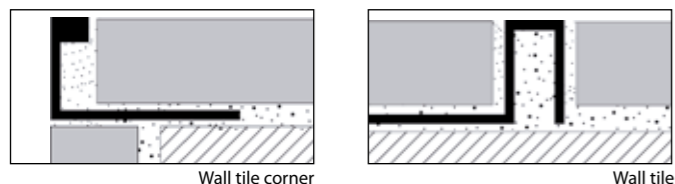

pro-mate 2

SAP		h (mm)	P/EU
100126769	Inox V2A	6	26.62 p/u

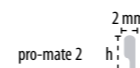

pro-mate 3

SAP		h (mm)	P/EU
100126772	Chrome	6	58.67 p/u
100126770	Anod.	6	18.57 p/u
100126771	Blanco	6	16.71 p/u

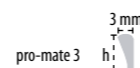

pro-mate 5

SAP		h (mm)	P/EU
100126779	Chrome	7	65.74 p/u

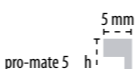

pro-part

SAP	Metal Shade 1	h (mm)	P/EU	SAP	Metal Shade 2	h (mm)	P/EU
100232244	rose	7	122.61 p/u	100297853	rose	7	122.61 p/u
100232236	rose line	7	124.25 p/u	100297828	rose line	7	124.25 p/u
100177056	moon	7	83.69 p/u	100297628	moon	7	83.69 p/u
100177063	moon line	7	85.53 p/u	100297638	moon line	7	85.53 p/u
100177070	ocean	7	83.69 p/u	100297965	ocean	7	83.69 p/u
100177064	ocean line	7	85.53 p/u	100297994	ocean line	7	85.53 p/u
100177037	graphite matt	7	90.24 p/u	100297570	graphite matt	7	90.24 p/u
100177055	graphite matt line	7	90.24 p/u	100297545	graphite matt line	7	90.24 p/u
100177049	graphite	7	86.72 p/u	100297518	graphite	7	86.72 p/u
100278752	old bronze	7	96.47 p/u				

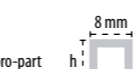

SAP	Texture	h (mm)	P/EU
100278708	bone	7	72.52 p/u
100278697	coal	7	72.52 p/u

SAP	Chrome	h (mm)	P/EU
100005368	chrome	7	72.35 p/u
100177061	line	7	79.84 p/u
100177062	line matt	7	79.84 p/u

SAP	Gold	h (mm)	P/EU
100246452	gold	7	121.86 p/u

SAP	Aluminium	h (mm)	P/EU
100005322	anodized silver	7	14.90 p/u
100220100	black	7	27.48 p/u



pro-part Li

SAP		h (mm)	a (mm)	P/EU
100126780	Chrome	4,5	5,5	89.62 p/u
100128227	Anod.	4,5	5,5	18.16 p/u



pro-mate 45 Top

SAP		h (mm)	P/EU
100126778	Chrome	6	66.06 p/u
100126777	Anod.	6	20.98 p/u



3 meter profiles

Profiles available in different shapes, from right-angled profiles for straight trims to rounded shape profiles.

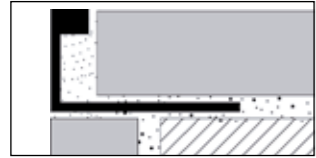

Wall tile corner

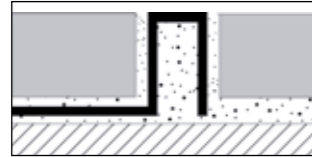

Wall tile



pro-mate 2

SAP		h (mm)	P/EU
100276385	Inox V2A	11	34.50 p/u
100276386	Inox V2A	12,5	35.78 p/u

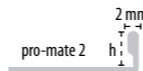

pro-mate 3

SAP		h (mm)	P/EU
100286309	Chrome	12,5	73.85 p/u
100276187	Alum. anod.	11	17.81 p/u
100276196	Alum. anod.	12,5	18.08 p/u
100286597	Alum. black	12,5	30.01 p/u
100276394	PVC white	12,5	6.68 p/u

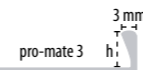

pro-mate 5

SAP		h (mm)	P/EU
100286603	Chrome	11	83.86 p/u

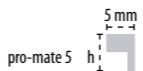

pro-part

SAP		h (mm)	P/EU
100286618	Chrome	11	93.66 p/u
100286360	Chrome	12,5	96.65 p/u

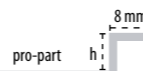

pro-part Li

SAP		h (mm)	P/EU
100276440	Inox V2A	11	47.46 p/u
100276480	Inox V2A	12,5	51.86 p/u
100276510	Inox. brillo	11	52.50 p/u
100276459	Inox. brillo	12,5	67.19 p/u
100276492	Inox. cep.	12,5	67.19 p/u
100276208	Alum. anod.	11	24.77 p/u
100276198	Alum. anod.	12,5	27.41 p/u

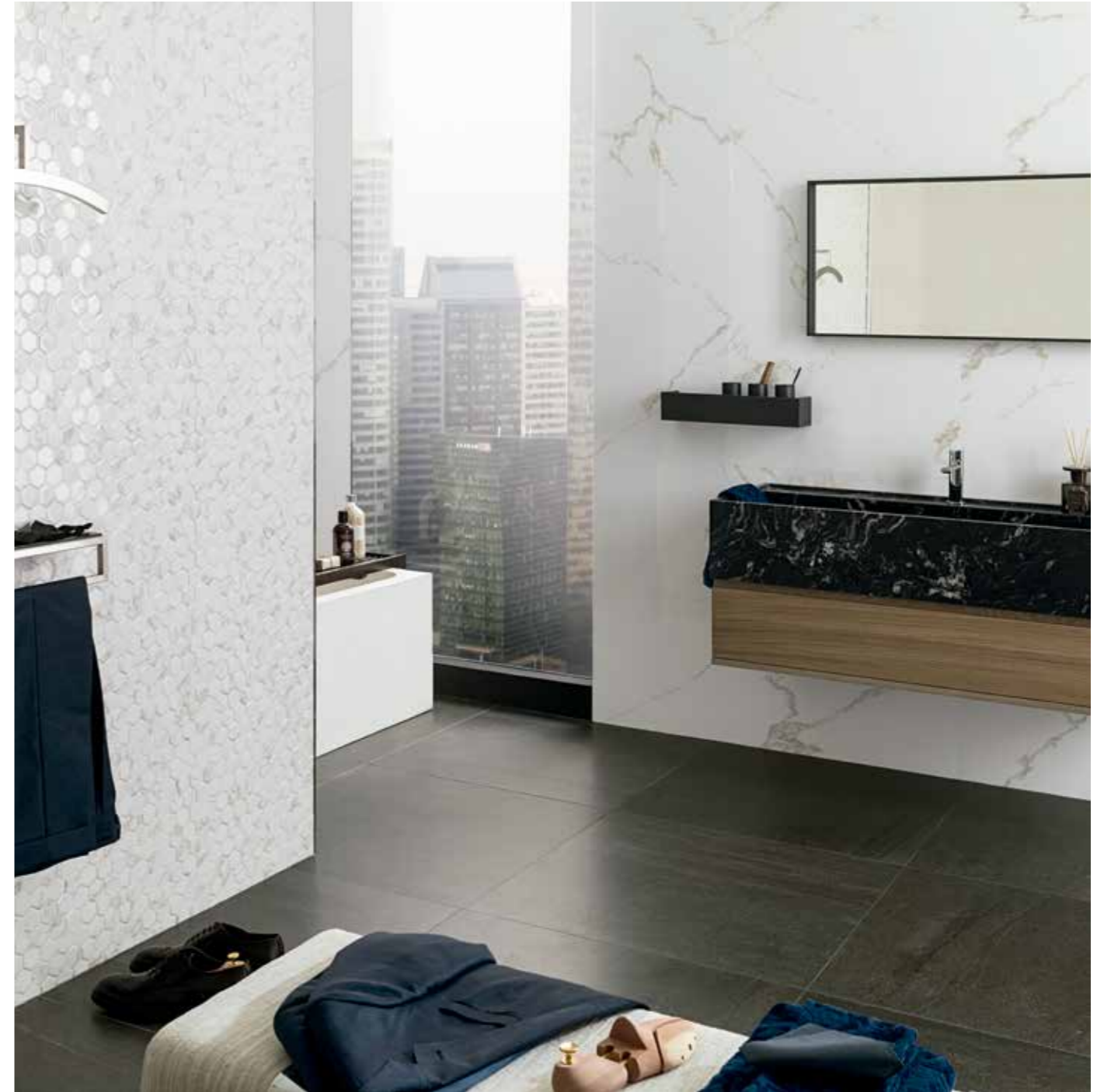
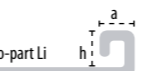

pro-mate 45

SAP		h (mm)	P/EU
100276415	PVC white	11	6.84 p/u
100276371	Inox.	10	44.96 p/u
100276372	Inox.	12,5	47.29 p/u
100276367	Alum. anod.	10	19.25 p/u
100276299	Alum. anod.	12,5	21.37 p/u
100276352	Alum. lac. white	11	23.17 p/u
100276319	Alum. lac. white	12,5	24.48 p/u





pro-T

Profile for transitions between floor coverings.

Profiles for transitions between tiles or slabs with slightly different heights. Available in two widths: 14 and 25 mm. Specially recommended for transitions between ceramic tiles and wooden floors.

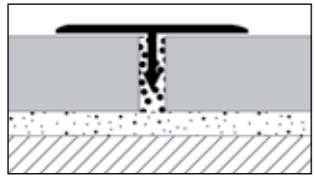

Floor tile



pro-T

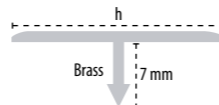

Chromed brass

SAP	h (mm)	P/EU
100005460	14	43.27 p/u
100005461	25	57.32 p/u

pro-T

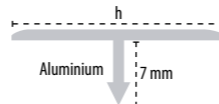

Anodized aluminium silver

SAP	h (mm)	P/EU
100005452	14	8.31 p/u
100005453	25	15.20 p/u

pro-T

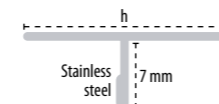

Gloss stainless steel

SAP	h (mm)	P/EU
100005462	14	39.12 p/u
100005463	25	54.91 p/u

Brushed stainless steel

SAP	h (mm)	P/EU
100005464	14	54.10 p/u
100005465	25	69.74 p/u

pro-level

Transition profile between floor coverings at different levels. It covers the non-glazed edge of the tile and protects it from shocks.

Technical profiles for small height differences between floor coverings. Available in rounded finish and sloped finish. Specially recommended for high transit floors.

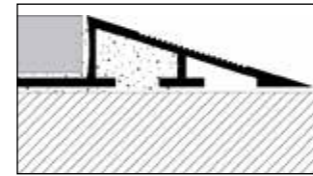

Floor tile

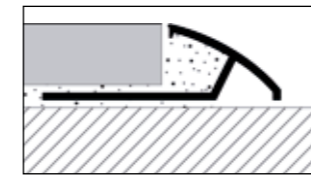

Floor tile



pro-level C

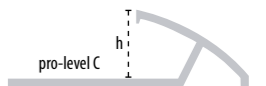

Anodized aluminium silver

SAP	h (mm)	P/EU
100005426	11	20.38 p/u
100005427	12,5	27.26 p/u

pro-level R



Anodized aluminium silver

SAP	h (mm)	P/EU
100005428	11	55.10 p/u
100005429	12,5	60.55 p/u
100005430	15	65.14 p/u
100005431	20	71.74 p/u

pro-shower

New range of profiles for shower trays. Designed to cover the sides of shower trays; specially for shower with only one direction slope. There are also special trims for installing glass screens.

These profiles are made of stainless steel and are available in two different finishings: gloss and brushed.

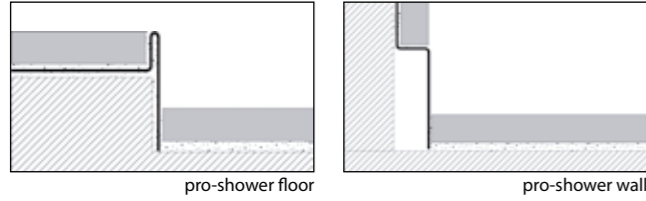

pro-shower floor



Chromed stainless steel				Brushed stainless steel					
SAP		h1 (mm)	h2 (mm)	P/EU	SAP	h1 (mm)	h2 (mm)	P/EU	
100159068	Left side	12,5	24	83.03 p/u	100159067	Left side	12,5	32	109.15 p/u
100160219	Right side	12,5	24	83.03 p/u	100160218	Right side	12,5	32	109.15 p/u
100159069	Left side	12,5	32	131.12 p/u					
100160280	Right side	12,5	32	131.12 p/u					

Profile length h2=24 980 mm
Profile length h2=32 1480 mm

Profile length h2=32 1480 mm

pro-shower wall



Chromed stainless steel				Brushed stainless steel					
SAP		h1 (mm)	h2 (mm)	P/EU	SAP	h1 (mm)	h2 (mm)	P/EU	
100159100	Left side	12,5	32	131.12 p/u	100159088	Left side	12,5	32	109.15 p/u
100160248	Right side	12,5	32	131.12 p/u	100160246	Right side	12,5	32	109.15 p/u

Profile length h2=32 1480 mm

Profile length h2=32 1480 mm

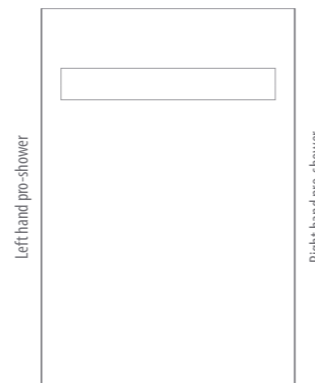

pro-sanit

Concave profile for installation where walls and floors meet or between wall coverings and bathtubs, shower trays or other bath elements. It substitutes the traditional curve ceramic piece.

It reduces the risk of water leakage and eases cleaning and preservation of angles between floor and wall coverings.

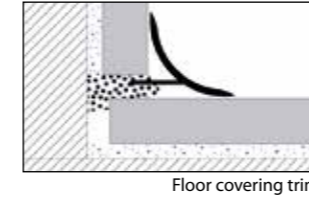

pro-sanit U1



High gloss aluminum		
SAP	h (mm)	P/EU
100062075	16	30.60 p/u
100062076	22	34.92 p/u

Anodized aluminium silver		
SAP	h (mm)	P/EU
100062077	16	13.23 p/u
100062078	22	16.56 p/u

Lacquered aluminium		
SAP	h (mm)	P/EU
100062079	white 16	18.52 p/u
100062080	white 22	23.16 p/u

pro-sanit U2



Stainless steel			Stainless steel corner		
SAP	h (mm)	P/EU	SAP	h (mm)	P/EU
100005566	Gloss 12,5	62.59 p/u	100005567	Gloss outer 12,5	10.22 p/u
100005569	Brushed 12,5	84.49 p/u	100005568	Gloss inner 12,5	10.22 p/u
			100005570	Brushed outer 12,5	10.22 p/u
			100005571	Brushed internal 12,5	10.22 p/u

pro-sanit U2

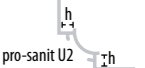

PVC		
SAP	h (mm)	P/EU
100005542	white 11 x 9	20.12 p/u

pro-dilata

Profile for movement joints in ceramic floor coverings.

PVC profiles with a central elastic joint for the absorption of tensions in the ceramic floor. Available in several colours and joint widths, they are the best solution for creating intermediate movement joints.

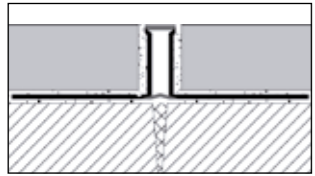

Floor tile

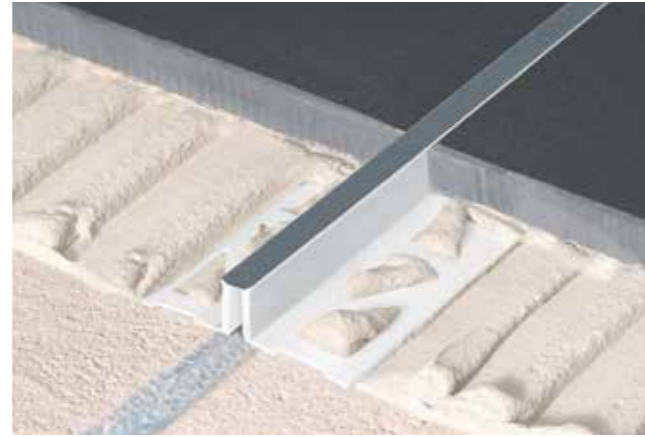

pro-dilata PVC

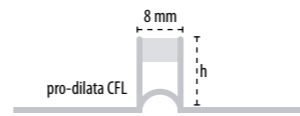
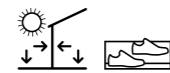

CFL 8 mm

SAP	h (mm)	P/EU
100005685	White 12,5	13.43 p/u
100005686	Beige 12,5	13.43 p/u
100005690	Beige 15	17.31 p/u
100005687	Black 12,5	13.43 p/u
100005691	Black 15	17.31 p/u
100005688	Grey 12,5	13.43 p/u
100005692	Grey 15	17.31 p/u

pro-dilata PVC

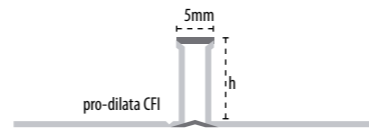
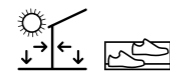

CFI 5 mm

SAP	h (mm)	P/EU
100159078	Light grey 11	13.67 p/u
100159080	Light grey 12,5	14.06 p/u
100159076	Grey 11	13.67 p/u
100159077	Grey 12,5	14.06 p/u
100159081	Black 11	13.67 p/u
100159082	Black 12,5	14.06 p/u
100159074	Beige 11	13.67 p/u
100159075	Beige 12,5	14.06 p/u

pro-dilata

Profile for movement joints in ceramic floor coverings.

Metal profiles with a central elastic joint for the absorption of tensions in the ceramic floor. New pro-dilata is a 8 and 10 mm wide precast expansion joint for indoor and outdoor ceramic floors.

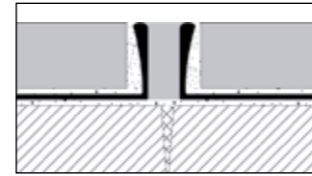

Floor tile



pro-dilata stainless steel

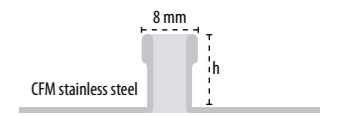
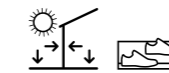

CFM 8 mm

SAP	h (mm)	P/EU
100005715	12,5	87.68 p/u
100005716	15	103.11 p/u
100005717	20	117.94 p/u

pro-dilata stainless steel nc

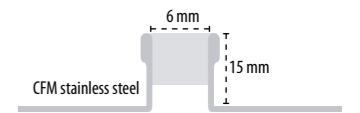
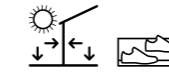

CFM 11,6 mm

SAP	h (mm)	P/EU
100280152	15	103.11 p/u

pro-dilata aluminium

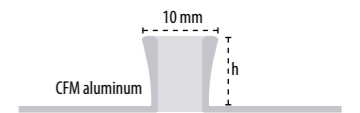
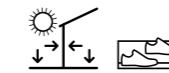

CFM 10 mm

SAP	h (mm)	P/EU
100005699	12,5	51.39 p/u
100005700	15	53.97 p/u
100005702	20	61.08 p/u

structural joints

Profile for structural joints in ceramic floor coverings.

Metallic profiles with a central elastic joint that absorbs the structural movements of the support. Available with deformable polypropylene joint for pedestrian transit and moving metallic joint for wheeled transit.

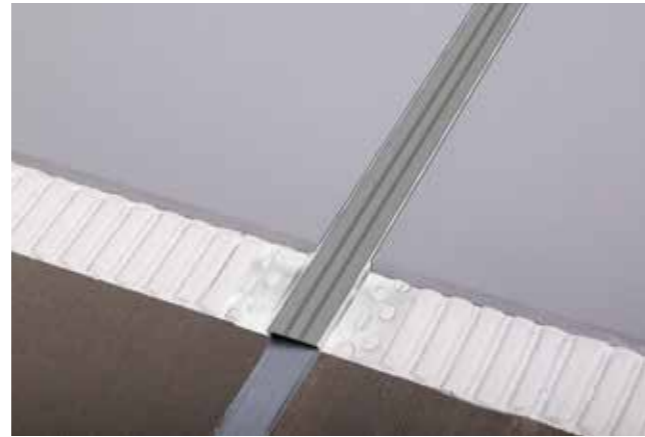
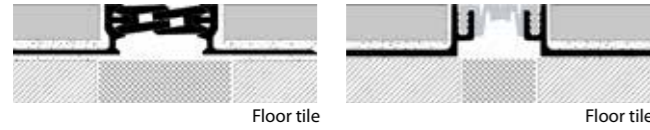

structural joints BT

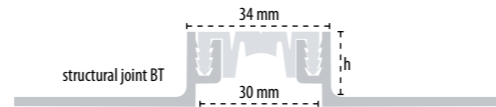

BT-40

SAP		h (mm)	P/EU
100298904	Grey	22	109.25 p/m
100298885	Grey	40	131.12 p/m

Accepted traffic: Pedestrian and vehicles with pneumatic wheels up to 35 kN.

structural joints AT

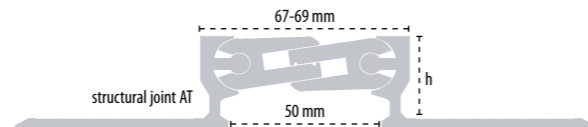
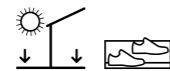

AT-50

SAP		h (mm)	P/EU
100285036		22	179.01 p/m
100285329		50	252.66 p/m

Accepted traffic: Pedestrian, vehicles with pneumatic wheels up to 300 kN and forklift trucks or solid wheeled hand pallet trucks up to 9 kg/mm.

pro-step

Profile for the making of stair steps. It substitutes the traditional step ceramic piece by a combination of ceramic tile and profile.

Metallic profiles that cover the non-glazed edge of the tile, protect it from shocks and reduce the risk of slipping.

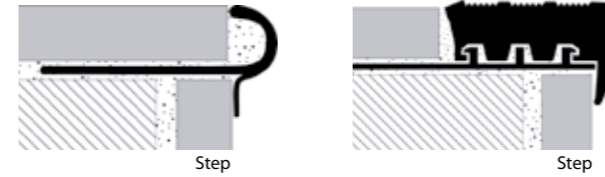

pro-step

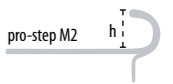
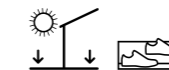

Stainless steel M2

SAP		h (mm)	P/EU
100005523		11	54.71 p/u

pro-step

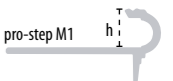
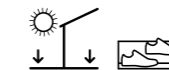

Anodized aluminium silver M1

SAP		h (mm)	P/EU
100005509		11	21.86 p/u
100067688		13,5	24.05 p/u

pro-step

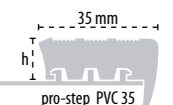
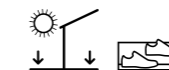

PVC 35

SAP		h (mm)	P/EU
100005482	Grey	11	47.70 p/u



Metal profiles. They replace traditional ceramic skirting. Specially recommended for shops and public buildings.



pro-skirting black



pro-skirting white



pro-skirting silver

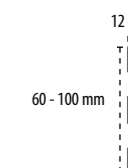

pro-skirting black

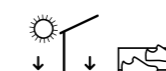

pro-skirting black			pro-skirting corner black		
SAP		P/EU	SAP		P/EU
100213522	12x60x2500 mm	28.77 p/u	100213153	12x60x12 mm	11.19 p/u
100225511	12x100x2500 mm	41.62 p/u	100236020	12x100x12 mm	10.91 p/u

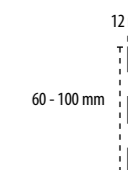

pro-skirting white

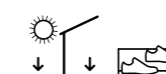

pro-skirting white			pro-skirting corner white		
SAP		P/EU	SAP		P/EU
100213533	12x60x2500 mm	27.16 p/u	100213200	12x60x12 mm	11.19 p/u
100225498	12x100x2500 mm	41.62 p/u	100235979	12x100x12 mm	10.91 p/u

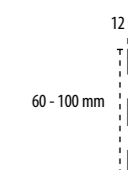

pro-skirting silver

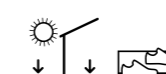

pro-skirting silver			pro-skirting corner silver		
SAP		P/EU	SAP		P/EU
100213532	12x60x2500 mm	28.77 p/u	100213199	12x60x12 mm	11.19 p/u
100225479	12x100x2500 mm	41.97 p/u	100235986	12x100x12 mm	10.91 p/u

Fixing clips pro-skirting

SAP		P/EU
100193608	17x30 mm 50 ud	13.93 p/bag

Profile length: 2500 mm

PRO-SKIRTING PAR-KER

Decorative skirtings for PAR-KER tiles by PORCELANOSA.
LIFESTYLE design.



pro-skirting Oxford Acero

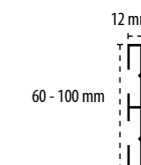

pro-skirting Oxford

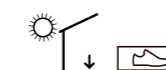

pro-skirting Oxford Acero			pro-skirting corner Oxford Acero		
SAP		P/EU	SAP		P/EU
100193645	12x60x1800 mm	30.66 p/u	100233474	12x60x12 mm	13.28 p/2u
100178475	12x100x1800 mm	33.22 p/u	100233572	12x100x12 mm	13.28 p/2u
pro-skirting Oxford Antracita			pro-skirting corner Oxford Antracita		
SAP		P/EU	SAP		P/EU
100193646	12x60x1800 mm	30.66 p/u	100233460	12x60x12 mm	13.28 p/2u
100178471	12x100x1800 mm	33.22 p/u	100233528	12x100x12 mm	13.28 p/2u
pro-skirting Oxford Castaño			pro-skirting corner Oxford Castaño		
SAP		P/EU	SAP		P/EU
100193605	12x60x1800 mm	30.66 p/u	100233419	12x60x12 mm	13.28 p/2u
100178435	12x100x1800 mm	33.22 p/u	100233570	12x100x12 mm	13.28 p/2u
pro-skirting Oxford Cognac			pro-skirting corner Oxford Cognac		
SAP		P/EU	SAP		P/EU
100193547	12x60x1800 mm	30.66 p/u	100233453	12x60x12 mm	13.28 p/2u
100178437	12x100x1800 mm	33.22 p/u	100233563	12x100x12 mm	13.28 p/2u
pro-skirting Oxford Natural			pro-skirting corner Oxford Natural		
SAP		P/EU	SAP		P/EU
100193598	12x60x1800 mm	30.66 p/u	100233438	12x60x12 mm	13.28 p/2u
100178462	12x100x1800 mm	33.22 p/u	100233547	12x100x12 mm	13.28 p/2u
pro-skirting Oxford Blanco			pro-skirting corner Oxford Blanco		
SAP		P/EU	SAP		P/EU
100193597	12x60x1800 mm	30.66 p/u	100233470	12x60x12 mm	13.28 p/2u
100178436	12x100x1800 mm	33.22 p/u	100233562	12x100x12 mm	13.28 p/2u

Fixing clips pro-skirting PAR-KER

SAP		P/EU
100193608	17x30 mm 50 ud	13.93 p/bag

Profile length: 1800 mm

PRO-SKIRTING PAR-KER

Decorative skirtings for PAR-KER tiles by PORCELANOSA.
LIFESTYLE design.



pro-skirting Ascot Teca

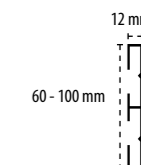

pro-skirting Ascot

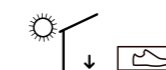

pro-skirting Ascot Teca

SAP	Dimensions	P/EU
100193642	12x60x1800 mm	30.66 p/u
100178466	12x100x1800 mm	33.22 p/u

pro-skirting corner Ascot Teca

SAP	Dimensions	P/EU
100233495	12x60x12 mm	13.28 p/2u
100233581	12x100x12 mm	13.28 p/2u

pro-skirting Ascot Arce

SAP	Dimensions	P/EU
100193595	12x60x1800 mm	30.66 p/u
100178480	12x100x1800 mm	33.22 p/u

pro-skirting corner Ascot Arce

SAP	Dimensions	P/EU
100233408	12x60x12 mm	13.28 p/2u
100233565	12x100x12 mm	13.28 p/2u

Fixing clips pro-skirting PAR-KER

SAP	Dimensions	P/EU
100193608	17x30 mm 50 ud	13.93 p/bag

Profile length: 1800 mm

PRO-SKIRTING PAR-KER

Decorative skirtings for PAR-KER tiles by PORCELANOSA.
LIFESTYLE design.



pro-skirting Manhattan Colonial

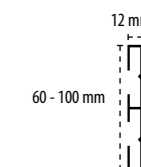

pro-skirting Manhattan

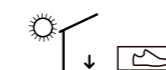

pro-skirting Manhattan Colonial			pro-skirting corner Manhattan Colonial		
SAP		P/EU	SAP		P/EU
100193603	12x60x1800 mm	30.66 p/u	100233574	12x60x12 mm	13.28 p/2u
100189248	12x100x1800 mm	33.22 p/u	100233555	12x100x12 mm	13.28 p/2u
pro-skirting Manhattan Maple			pro-skirting corner Manhattan Maple		
SAP		P/EU	SAP		P/EU
100193604	12x60x1800 mm	30.66 p/u	100233398	12x60x12 mm	13.28 p/2u
100191461	12x100x1800 mm	33.22 p/u	100233499	12x100x12 mm	13.28 p/2u
pro-skirting Manhattan Cognac			pro-skirting corner Manhattan Cognac		
SAP		P/EU	SAP		P/EU
100193602	12x60x1800 mm	30.66 p/u	100233621	12x60x12 mm	13.28 p/2u
100191470	12x100x1800 mm	33.22 p/u	100233517	12x100x12 mm	13.28 p/2u

Fixing clips pro-skirting PAR-KER

SAP	P/EU
100193608 17x30 mm 50 ud	13.93 p/bag

Profile length: 1800 mm

pro-skirting Manhattan Colonial

PRO-SKIRTING PAR-KER

Decorative skirtings for PAR-KER tiles by PORCELANOSA.
LIFESTYLE design.



pro-skirting Delaware Acero

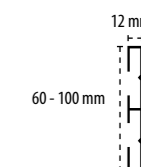

pro-skirting Delaware



pro-skirting Delaware Natural			pro-skirting corner Delaware Natural		
SAP		P/EU	SAP		P/EU
100226719	12x60x1800 mm	30.66 p/u	100233593	12x60x12 mm	13.28 p/2u
100222010	12x100x1800 mm	32.42 p/u	100233552	12x100x12 mm	13.28 p/2u
pro-skirting Delaware Nogal			pro-skirting corner Delaware Nogal		
SAP		P/EU	SAP		P/EU
100226740	12x60x1800 mm	30.66 p/u	100233612	12x60x12 mm	13.28 p/2u
100222027	12x100x1800 mm	32.42 p/u	100233536	12x100x12 mm	13.28 p/2u

Fixing clips pro-skirting PAR-KER

SAP	P/EU
100193608 17x30 mm 50 ud	13.93 p/bag

Profile length: 1800 mm

pro-skirting Delaware Acero



pro-skirting Nobu Arce

PRO-SKIRTING PAR-KER

Decorative skirtings for PAR-KER tiles by PORCELANOSA.
LIFESTYLE design.



pro-skirting Nobu Arce

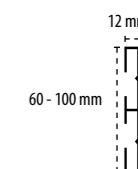

pro-skirting Nobu

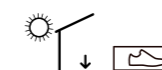

pro-skirting Nobu Arce

SAP		P/EU
100243369	12x60x1800 mm	29.92 p/u
100243412	12x100x1800 mm	32.42 p/u

pro-skirting Nobu Roble

SAP		P/EU
100243440	12x60x1800 mm	29.92 p/u
100243420	12x100x1800 mm	32.42 p/u

Fixing clips pro-skirting PAR-KER

SAP		P/EU
100193608	17x30 mm 50 ud	13.93 p/bag

Profile length: 1800 mm

Metallic profiles for skirtings. They have a high mechanical resistance with a functional, modern design. Specially recommended for office floors and raised access floors.

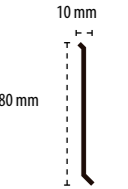

pro-plint stainless steel

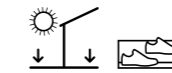

pro-plint stainless steel

SAP		P/EU
100005635	brillante	42.51 p/u
100005636	cepillado	50.07 p/u

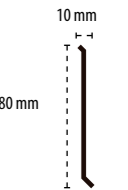

pro-plint anodized aluminium

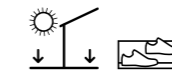

pro-plint anodized aluminium

SAP		P/EU
100073104	Silver	38.98 p/u

pro-plint corner anodized aluminium

SAP		P/EU
100073105	Outer	5.85 p/u
100073106	Internal	7.08 p/u

pro-plint lateral cap

SAP		P/EU
100073107	Right	7.38 p/u
100073108	Left	4.37 p/u

pro-plint connection

SAP	P/EU
100073109	6.83 p/u



pro-plint stainless steel

Profile length: 2500 mm



ADHESIVES

CEMENT-BASED ADHESIVES

tixocem plus, **114** | flexitec n, **115** | fr-one n, **116** | rapimax n, **117**
maxifluid, **118** | one-flex Premium, **119** | super-one n, **120** | super-flex S2, **121**

ADDITIVES FOR CEMENT-BASED ADHESIVES

r eco, **122** | unilax, **123**

REACTIVE RESINS ADHESIVES

politech n, **124** | politech Premium, **125** | linkfloor fix, **126**

POLYMER ADHESIVE

h-920, **129**

FAÇADE FIXINGS

Concealed facade fixings, **130** | Visible facade fixings, **131**

tixocem plus

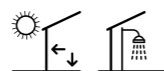

tixocem plus is a type C1TE cement-based adhesive as per EN 12004, suitable for laying absorbent ceramic tiles using the thin-bed method on cement, plasterboard substrates and for laying non-absorbent ceramic tiles on cement-based substrates. Specially recommended for laying porcelain tiles indoors.

It solves simply and effectively the laying of absorbent ceramic tiles on cement-based, plasterboard or brick supports. With this adhesive, tiles can be laid on a medium-bed layer on uneven substrates. It can be laid on thicknesses up to 10 mm. Waterproof and frost-resistant.

Certifications / Standards:

EN 12004 C1TE



Features:

- Cement-based, single component adhesive.
- Optimal workability. Thixotropic.
- Extended working times. Open time higher than 30 min.
- Application thickness up to 10 mm.
- Frost-resistant.
- Mixing water: 8 L per 25 kg bag

Recommended uses:

- Medium and small format wall tile coverings for indoor use.
- Medium format porcelain floor tile coverings for indoor use.
- Medium format floor tile coverings for indoor use.
- Uneven substrates.

Substrates:

- Cement-based screeds
- Cement render
- Anhydrite screeds, having previously applied **uniprim**
- Plasters, having previously applied **uniprim**
- Large-format ceramic brick
- Plasterboard panels

Materials:

- Medium and small format ceramic tiles
- High-absorption ceramic tiles and stoneware
- Porcelain tile

Coverage:

- Small format and mosaic / Trowel U4: 2-3 kg/m²
- Medium format / Trowels U6-U8: 3-5 kg/m²
- Large format / Trowels U10-U12: 5-7 kg/m²

Regardless of our recommendations for use indicated for this adhesive, respect the installation regulations in force in each country.

Before using this product in any application not indicated in this catalogue, please perform a test or refer to the product's technical sheet.

tixocem plus

SAP		Presentation	Europallet	P/EU
100043280	tixocem blanco	bag 25 kg	1200 kg/pallet	0.52 p/kg

flexitec n

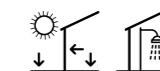

flexitec n is a type C2TE cement-based adhesive, suitable for laying porcelain tiles, on cement-based substrates or flexible substrates like plasterboard. Its excellent conditions of use make it especially recommendable.

A medium-elasticity cement-based adhesive for laying absorbent ceramic tiles, stoneware or porcelain tiles using the thin-bed method. Thixotropic.

Certifications/Standards:

EN 12004 C2TE



CSTB: 2454-222 MC 299 C2-E



Features:

- Cement-based, single component adhesive.
- Excellent adherence. Medium flexibility.
- Fine texture mortar, with excellent mixing and application features.
- High initial adherence and no sagging.
- Extended working times. Open time higher than 30 min.
- Application thickness up to 6 mm.
- Frost-resistant.
- Mixing water:
 - White: 7,25 - 7,75 l per 25 kg bag
 - Grey: 6,75 - 7,25 l per 25 kg bag

Recommended uses:

- Indoor wall tile coverings.
- Indoor and outdoor porcelain tile coverings.

Substrates:

- Cement-based screeds
- Cement render
- Concrete slabs and floors
- Anhydrite screeds, having previously applied **uniprim**
- Plasters, having previously applied **uniprim**
- Plasterboard panels

Materials:

- Medium and small format ceramic tiles
- High-absorption ceramic tiles and stoneware
- Porcelain tiles

Coverage:

- Small format and mosaic / Trowel U4: 2-3 kg/m²
- Medium format / Trowels U6-U8: 3-5 kg/m²
- Large format / Trowels U10-U12: 5-7 kg/m²

Regardless of our recommendations for use indicated for this adhesive, respect the installation regulations in force in each country.

Before using this product in any application not indicated in this catalogue, please perform a test or refer to the product's technical sheet.

flexitec n

SAP		Presentation	Europallet	P/EU
100004232	flexitec n blanco	bag 25 kg	1000 kg/pallet	0.92 p/kg
100004230	flexitec n gris	bag 25 kg	1000 kg/pallet	0.87 p/kg
100277878	r-eco	bag 250 gr		1.02 p/u

fr-one n

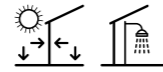

fr-one n is a type C2TE high-tech cement-based adhesive, as per EN 12004, for laying all kinds of ceramic tiles on the most used substrates in the building industry. Specially recommended for large format tiles and uneven substrates.

Advanced, high-performance, single-component, easy to use adhesive for laying all kinds of ceramic tiles. With this adhesive, tiles can be laid on a medium-bed layer on uneven substrates. It can be laid on thicknesses up to 15 mm. Specially recommended for porcelain floor tiles, antiqued marble, large formats and pools. Thixotropic.



Certifications/Standards:

EN 12004 C2TE
 CSTB: 2452-243 MC 301 C2-E

Features:

- Cement-based, single component adhesive.
- Excellent adherence.
- Optimal workability. Extended working times. Open time higher than 30 min.
- High initial adherence and no sagging.
- Application thickness up to 15 mm.
- Frost-resistant.
- Mixing water: 7 - 7.50 L per 25 kg bag

Recommended uses:

- Large format interior wall tiles
- Large format interior porcelain floor tiles and outdoor use
- Uneven substrates
- High traffic floor tiles
- Damp environments
- On bonded facades, replace mixing water with **unilax** additive

Substrates:

- Cement-based screeds
- Cement render
- Concrete slabs and floors
- Anhydrite screeds, having previously applied **uniprim**
- Plasters, having previously applied **uniprim**
- Large-format ceramic brick
- Pre-existing tiles/mosaic/stones*
- Plasterboard panels

Materials:

- Large format ceramic tiles
- High-absorption ceramic tiles and stoneware
- Porcelain tiles
- Glass mosaic
- Natural stone and marble not prone to staining

Coverage:

- Small format and mosaic / Trowel U4: 2-3 kg/m²
- Medium format / Trowels U6-U8: 3-5 kg/m²
- Large format / Trowels U10-U12: 5-7 kg/m²

Regardless of our recommendations for use indicated for this adhesive, respect the installation regulations in force in each country.

* super-prim improves the adherence on polished ceramics and glossy finishing tiles

Before using this product in any application not indicated in this catalogue, please perform a test or refer to the product's technical sheet.

fr-one n

SAP		Presentation	Europallet	P/EU
100004241	fr-one n blanco	bag 25 kg	1000 kg/pallet	1.03 p/kg
100004244	fr-one n gris	bag 25 kg	1000 kg/pallet	0.97 p/kg
100277878	r-eco	bag 250 gr		1.02 p/u

rapimax n

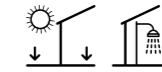

rapimax n is a type C2E high-tech cement-based adhesive, as per EN 12004, for laying all kinds of ceramic tiles on floors. Its high wettability and fluidity ensure full coverage of the underside of tiles without having to resort to the floating and buttering method.

A high-performance fluid adhesive for laying void-free ceramic floors. Specially recommended for porcelain floor tiles, terracotta and large formats. Indoors and outdoors.



Certifications/Standards:

EN 12004 C2E

Features:

- Cement-based, single component adhesive.
- A fluid mortar, applicable with a notched trowel, that under the tile pressure, flows and covers the whole back of the tile.
- Excellent adherence.
- Extended working times. Open time higher than 30 min.
- Application thickness up to 10 mm.
- Frost-resistant.
- Mixing water: 5.0 - 5.5 l per 25 kg bag

Recommended uses:

- Large format indoor porcelain floor tiles and outdoor use
- High traffic floor tiles
- Laying of tiles on existing glazed floor tiles
- Never use in walls

Substrates:

- Cement-based screeds
- Anhydrite screeds, having previously applied **uniprim**
- Concrete slabs and floors
- Pre-existing tiles/mosaic/stones*

Materials:

- Large format ceramic tiles in interiors
- High-absorption ceramic tiles and stoneware
- Porcelain tiles
- Clay and terracotta tiles
- Natural stone and marble not prone to staining

Coverage:

- Small format and mosaic / Trowels U6-U8: 4-6 kg/m²
- Medium format / Trowels U10-U12: 6-8 kg/m²
- Large format / Trowel N10: 6-8 kg/m²

Regardless of our recommendations for use indicated for this adhesive, respect the installation regulations in force in each country.

* super-prim improves the adherence on polished ceramics and glossy finishing tiles

Before using this product in any application not indicated in this catalogue, please perform a test or refer to the product's technical sheet.

rapimax n

SAP		Presentation	Europallet	P/EU
100004238	rapimax n gris	bag 25 kg	1000 kg/pallet	0.98 p/kg
100277878	r-eco	bag 250 gr		1.02 p/u

maxifluid

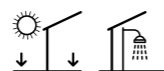

maxifluid is a type C2ES1 high-performance cement-based adhesive, as per EN 12004, for laying all kinds of ceramic tiles on floors. Its high wettability and fluidity ensure full coverage of the underside of tiles without having to resort to the floating and buttering method.

A high-performance fluid, flexible adhesive for laying void-free ceramic floors. Specially recommended for porcelain floor tiles, terracotta and large formats. Indoors and outdoors.

Certifications/Standards:

EN 12004 C2ES1
CSTB: 2456-222 MC 298 C2-S1-EG



Features:

- Cement-based, single component adhesive.
- A fluid mortar, applicable with a notched trowel, that under the tile pressure, flows and covers the whole back of the tile.
- Excellent adherence.
- Flexible.
- Extended working times. Open time higher than 30 min.
- Application thickness up to 10 mm.
- Frost-resistant.
- Mixing water: 5.0 - 5.5 l per 25 kg bag

Recommended uses:

- Indoor and outdoor porcelain floor tiles
- Large format porcelain floor tiles
- High traffic floor tiles
- Floor tiles with radiant heating
- Laying of tiles on existing glazed floor tiles
- Never use for wall tiles

Substrates:

- Cement-based screeds
- Concrete slabs and floors
- Anhydrite screeds, having previously applied **uniprim**
- Pre-existing tiles/mosaic/stones*
- Mixed with **unilax**, acoustic insulation **fonopac r**

Materials:

- Large format ceramic tiles
- High-absorption ceramic tiles and stoneware
- Porcelain tiles
- Clay and terracotta tiles
- Natural stone and marble not prone to staining

Coverage:

- Small format and mosaic / Trowels U6-U8: 4-6 kg/m²
- Medium format / Trowels U10-U12: 6-8 kg/m²
- Large format / Trowel U10: 6-8 kg/m²

Regardless of our recommendations for use indicated for this adhesive, respect the installation regulations in force in each country.

* super-prim improves the adherence on polished ceramics and glossy finishing tiles

Before using this product in any application not indicated in this catalogue, please perform a test or refer to the product's technical sheet.

maxifluid

SAP		Presentation	Europallet	P/EU
100033113	maxifluid gris	bag 25 kg	1000 kg/pallet	1.01 p/kg
100277878	r-eco	bag 250 gr		1.02 p/u

one-flex Premium

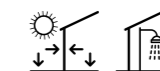

one-flex Premium is a type C2TES1 high-performance cement-based adhesive, as per EN 12004, for laying all kinds of ceramic tiles on the most used substrates in the building.

Very easy to use, one-flex premium can be prepared with a wide range of mixing water giving different properties to the adhesive: high wettability for large floor tiles or an excellent consistency for bedding thickness up to 15mm. Professional use.

Certifications/Standards:

EN 12004 C2TES1
CSTB : 2947-243 MC 574 C2-S1-E



Features:

- Excellent adherence. Flexible.
- Bonding material, with excellent mixing and application features.
- High initial adherence and no sagging. Thixotropic.
- Extended working times. Open time higher than 30 min.
- Application thickness from 2 to 15 mm.
- Broad spectrum in the percentage of mixing water:
one-flex premium white
Mixing water: 8.1 - 8.9 L per 25 kg bag
one-flex premium grey
Mixing water: 6.5 - 7.2 L per 25 kg bag

Recommended uses:

- Floors and walls with rectified tiles
- Large format indoor porcelain wall tiles
- Large format interior porcelain floor tiles and outdoor use
- High traffic floor tiles
- Floor tiles on radiant heating
- Pools and damp environments
- On bonded facades, replace mixing water with **unilax** additive

Substrates:

- Cement-based screeds
- Cement render
- Concrete slabs and floors
- Anhydrite screeds, having previously applied **uniprim**
- Plasters, having previously applied **uniprim**
- Large-format ceramic brick
- Pre-existing tiles/mosaic/stones*
- Plasterboard panels
- Cement-based panels
- Mixed with **unilax**, acoustic insulation **fonopac r**

Materials:

- Large format ceramic tiles
- High-absorption ceramic tiles and stoneware
- Porcelain tiles
- Glass mosaic
- Natural stone and marble not prone to staining

Coverage:

- Small format and mosaic / Trowel U4: 2-3 kg/m²
- Medium format / Trowels U6-U8: 3-5 kg/m²
- Large format / Trowels U10-U12: 5-7 kg/m²

Regardless of our recommendations for use indicated for this adhesive, respect the installation regulations in force in each country.

* super-prim improves the adherence on polished ceramics and glossy finishing tiles

Before using this product in any application not indicated in this catalogue, please perform a test or refer to the product's technical sheet.

one-flex Premium

SAP		Presentation	Europallet	P/EU
100201526	one-flex Premium blanco	bag 25 kg	1000 kg/pallet	1.29 p/kg
100201543	one-flex Premium gris	bag 25 kg	1000 kg/pallet	1.23 p/kg
100277878	r-eco	bag 250 gr		1.02 p/u

super-one n

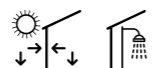

super-one n is a type C2FTS1 high-performance cement-based adhesive, as per EN 12004, ready for traffic after 4 hours. Specially recommended for quick installation and use of ceramic tiles and natural stone.

It solves the need of quick installation of any kind of format and ceramic tile, including porcelain tiles. Ready for traffic in just 4 hours, this adhesive can be used to lay ceramic tiles and natural stone in environments where high mechanical performance is needed, such as commercial or industrial flooring or flooring with radiant heating. Waterproof and frost-resistant.

Certifications/Standards:

EN 12004 C2FTS1
 CSTB: 2455-252 MC 312 C2-S1-F

Features:

- Cement-based, single component adhesive.
- Ready for traffic in just 4 hours.
- Excellent adherence. Flexible.
- Fine texture mortar, with excellent mixing and application features.
- High initial adherence and no sagging.
- Extended working times. Open time higher than 30 min.
- Application thickness up to 10 mm.
- Frost-resistant.
- Mixing water: 6.0 - 6.50 l per 25 kg bag

Recommended uses:

- Laying of ceramics in refurbishing jobs
- Floors and walls with natural stone**
- Indoor large format ceramic wall tiles
- Large format indoor and outdoor porcelain wall tiles
- Plywood substrates
- High traffic floor tiles
- Floor tiles on radiant heating
- Pools and damp environments
- On bonded facades, replace mixing water with **unilax** additive
- In marble composite floors as DQS in areas with no direct sunlight, replace mixing water by **unilax** additive

Substrates:

- Cement-based screeds
- Cement render
- Concrete slabs and floors
- Anhydrite screeds, having previously applied **uniprim**
- Plasters, having previously applied **uniprim**
- Pre-existing tiles/mosaic/stones*
- Plasterboard panels
- Cement-based panels
- Mixed with **unilax**, acoustic insulation **fonopac r**

Materials:

- Large format ceramic tiles
- High-absorption ceramic tiles and stoneware
- Porcelain tiles
- Glass mosaic
- Natural stone and marble not prone to staining
- Natural stone and marble prone to staining
- Mixed with **unilax**, DQS, and other marble agglomerate

Coverage:

- Small format and mosaic / Trowel U4: 2-3 kg/m²
- Medium format / Trowels U6-U8: 3-5 kg/m²
- Large format / Trowels U10-U12: 5-7 kg/m²

Regardless of our recommendations for use indicated for this adhesive, respect the installation regulations in force in each country.

* super-prim improves the adherence on polished ceramics and glossy finishing tiles

** For slate or similar please contact the Butech technical department

Before using this product in any application not indicated in this catalogue, please perform a test or refer to the product's technical sheet.

super-one n

SAP		Presentation	Europallet	P/EU
100031188	super-one n blanco	bag 25 kg	1000 kg/pallet	1.68 p/kg
100031189	super-one n gris	bag 25 kg	1000 kg/pallet	1.17 p/kg
100277878	r-eco	bag 250 gr		1.02 p/u

super-flex S2

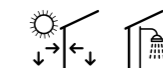

super-flex S2 is a type C2ES2 high-performance no dust cement-based adhesive, as per EN 12004, for laying all kinds of ceramic tiles on the most used substrates in the building industry. Specially recommended for laying large format, thin porcelain tiles like XTONE and XLIGHT from URBATEK.

This adhesive features excellent performance in adherence and deformability with no need for mixing with additives and excellent conditions of use: low dust generation and an only 15 kg package. This state-of-the-art adhesive includes additives and polymers which increase performance. This means that with a 15 kg bag of super-flex S2 you can lay the same tiles surface than with a 25 kg bag of regular adhesive.

Certifications/Standards:

EN 12004 C2ES2

Features:

- Cement-based, single component adhesive.
- Lightened adhesive. Low consumption onsite.
- Low emission of dust and other airborne particles.
- Maximum adherence and deformability.
- High initial adherence and no sagging. Thixotropic.
- Extended working times. Open time higher than 30 min.
- Application thickness up to 10 mm.
- Frost-resistant.
- Mixing water: 6 l per 15 kg bag

Recommended uses:

- Interior walls with slim tiles as XTONE and XLIGHT
- Floors and walls with XTONE and XLIGHT
- Large format indoor and outdoor ceramic wall tiles
- Large format indoor and outdoor porcelain floor tiles
- High traffic floor tiles
- Floor tiles on radiant heating
- Pools and damp environments

Substrates:

- Cement-based screeds
- Cement render
- Concrete slabs and floors
- Anhydrite screeds, having previously applied **uniprim**
- Plasters, having previously applied **uniprim**
- Pre-existing tiles/mosaic/stones*
- Plasterboard panels
- Cement-based panels
- acoustic insulation **fonopac r**

Materials:

- Large format ceramic tiles
- High-absorption ceramic tiles and stoneware
- Porcelain tiles
- XTONE and XLIGHT
- Glass mosaic
- Natural stone and marble not prone to staining
- DQS and other marble agglomerate

Coverage:

- Small format and mosaic / Trowel U4: 2 kg/m²
- Medium format / Trowels U6-U8: 2-4 kg/m²
- Large format / Trowels U10-U12: 4-6 kg/m²

Regardless of our recommendations for use indicated for this adhesive, respect the installation regulations in force in each country.

* super-prim improves the adherence on polished ceramics and glossy finishing tiles

Before using this product in any application not indicated in this catalogue, please perform a test or refer to the product's technical sheet.

super-flex S2

SAP		Presentation	Europallet	P/EU
100142757	super-flex S2 blanco	bag 15 kg	600 kg/pallet	3.37 p/kg
100277878	r-eco	bag 250 gr		1.02 p/u



r eco

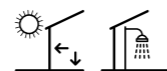

r eco is the first additive for cement-based adhesives that includes recycled plastic in its composition. Developed from fine PET flakes, it is incorporated into the mix of Butech's cement-based adhesives, participating in the reduction of plastic contamination without affecting the performance of the bonding material. Indoor use.

r-eco includes 250 gr. of 100% recycled plastic in each 25 kg bag of adhesive, equivalent to 50 supermarket bags. With a simple gesture, if this additive were used in the laying of all the ceramics produced by PORCELANOSA, around 1,000 Tm of plastic would be recycled, reducing waste and improving the state of our planet.

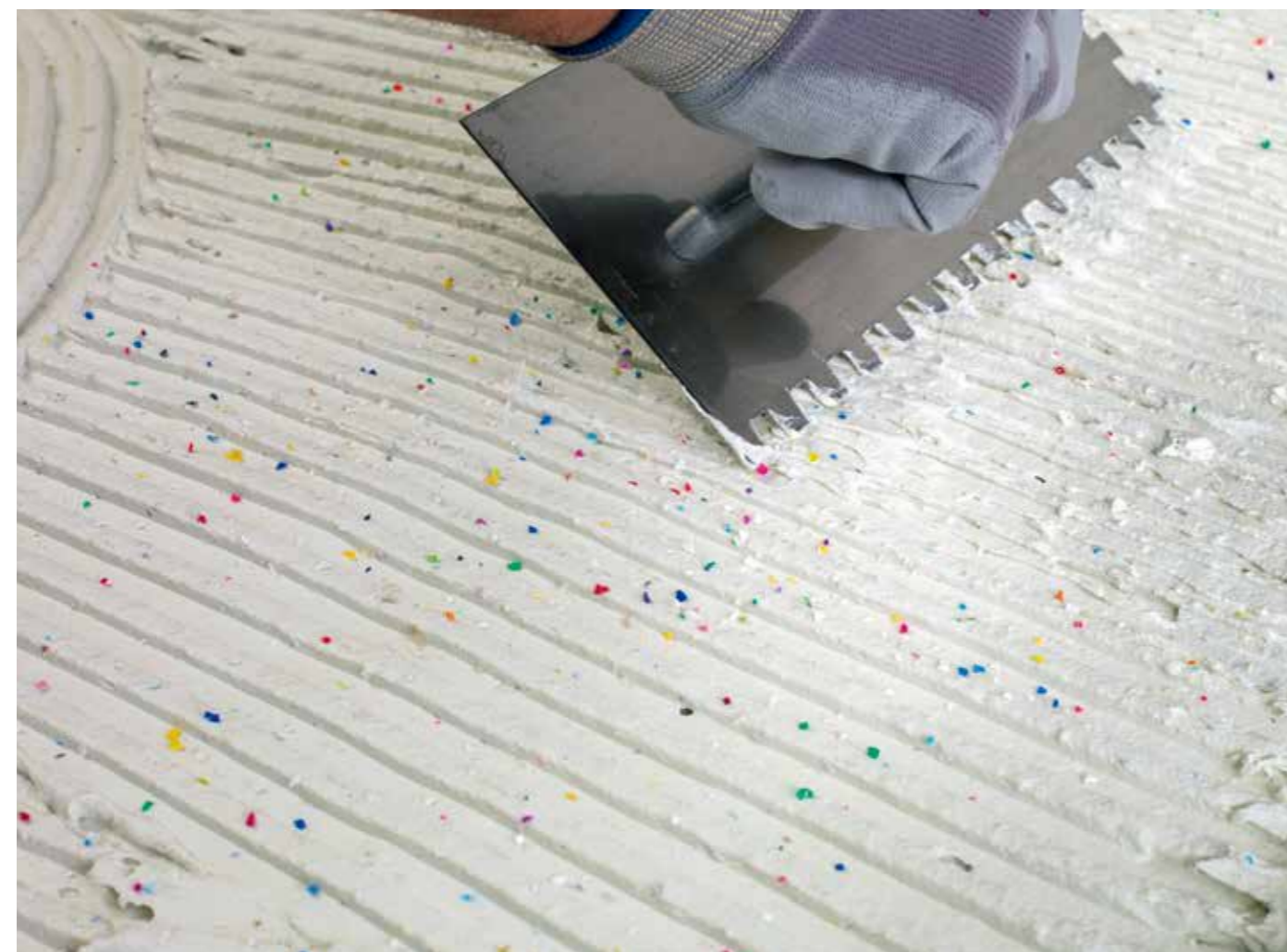

Features:

- Manufactured from PET bottles
- Origin: Post-consumption collected and treated in EC
- Particle size: < 0.2 mm
- Density: 0,575 gr/cm3
- Compatible with Butech's C2 type adhesives
- Percentage in mix: 250 gr of r-eco per 25 kg bag
- Indoor use

Compatible with the following adhesives:

- tixocem plus
- flexitec n
- fr-one n
- rapimax n
- maxifluid
- one-flex Premium
- super-one n

r eco

SAP	Presentation	P/EU
100277878	r-eco bag 250 gr	1.02 p/u

unilax

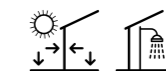

unilax is a latex that, mixed with cement-based adhesives like one-flex Premium, fr-one n or super one n, rapimax n or maxifluid improves bonding strength and flexibility up to level C2S2 as per EN 12004. Specially recommended for laying wall tiles outdoors.

A resin-based latex that can be added to cement-based adhesives to enhance their bonding strength and flexibility. Specially recommended for exterior facades.



Features:

- Water-based acrylic resins latex.
- Resistant to the most common chemicals.
- Excellent resistance to UV rays and the effect of heat.
- Frost-resistant.

Recommended uses:

- Laying of tiles in facades.
- Large format ceramic floor tiles on radiant heating.
- Indoor large format ceramic tile coverings on slightly deformable substrates.
- Indoor and outdoor porcelain tile coverings.
- High traffic floor tiles.
- Pools and damp environments.

Substrates:

- Cement-based screeds
- Cement render
- Concrete slabs and floors
- Anhydrite screeds, having previously applied uniprim
- Plasters, having previously applied uniprim
- Pre-existing tiles/mosaic/stones*
- Plasterboard panels
- Cement-based panels

Materials:

- Large format ceramic tiles
- High-absorption ceramic tiles and stoneware
- Porcelain tiles
- Glass mosaic
- Natural stone and marble not prone to staining
- Natural stone and marble prone to staining
- DQS and other marble agglomerate

Coverage:

- For each cementitious adhesive, replace the water in the mixing with the same amount of **unilax**.

* **super-prim** improves the adherence on polished ceramics and glossy finishing tiles

Before using this product in any application not indicated in this catalogue, please perform a test or refer to the product's technical sheet.

unilax

SAP	Presentation	Europallet	P/EU
100004376	unilax can 20 kg	560 kg/pallet	5.20 p/kg
100004377	unilax can 5 kg	480 kg/pallet	5.70 p/kg

politech n

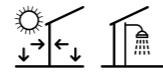

politech n is a type R2T high-tech, two-component polyurethane adhesive as per EN 12004, for laying tiles on deformable substrates. Specially recommended for special substrates like metal sheets or synthetic materials, where cement-based adhesives cannot be used.

A high-tech two-component polyurethane adhesive with high performance properties. Suitable for laying ceramic tiles of all kinds on deformable substrates.



Certifications/Standards:
EN 12004 R2T

Features:

- Two-component polyurethane adhesive.
- Excellent adherence. Maximum deformability.
- No water absorption. Waterproof.
- High chemical resistance.
- High initial adherence and no sagging.
- Application thickness up to 8 mm.
- Frost-resistant.

Recommended uses:

- Laying of wall tiles not compatible with cement-based adhesives
- Wall tiles on substrates not compatible with cement-based adhesives
- Floor tiles on deformable substrates
- Floor tiles with special chemical resistance
- Pools and damp environments, steam rooms and spas
- Stone sheets for wall coverings as AIRSLATE by L'ANTIC COLONIAL
- Laying of slate and other natural stones with risk of deformation by water absorption.
- Interior floors as DQS by L'ANTIC COLONIAL and other marble composites
- KRION sheets

Substrates:

- Cement-based screeds
- Cement render
- Concrete slabs and floors
- Anhydrite screeds
- Renders and plasterboards
- Pre-existing tiles/mosaic/stones*
- Plasterboard panels
- Cement-based panels
- Wood panels
- Metal surfaces
- Polyester or PVC surfaces
- Glass surfaces

Materials:

- Large format ceramic tiles
- High-absorption ceramic tiles and stoneware
- Porcelain tiles
- XTONE and XLIGHT
- Glass mosaic
- Natural stone and marble not prone to staining
- Natural stone and marble prone to staining
- Slates and similar sensitive to contact with water
- AIRSLATE
- DQS and other marble agglomerate
- KRION and other kinds of solid surface

Coverage:

- Small format and mosaic / Trowel U3: 2 kg/m²
- Medium format / Trowels U4: 2-3 kg/m²
- Large format / Trowels U6: 3-4 kg/m²

Regardless of our recommendations for use indicated for this adhesive, respect the installation regulations in force in each country.

Before using this product in any application not indicated in this catalogue, please perform a test or refer to the product's technical sheet.

politech n

SAP	Presentation	Europallet	P/EU
100138260	politech n blanco can 12 kg	576 kg/pallet	9.67 p/kg

politech Premium

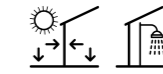

politech Premium is a reactive resin adhesive that is super easy to handle and easy to use, especially when we need maximum bonding strength and deformability. It is suitable for most wall coverings and substrates used in construction, ensuring the correct installation of materials such as L'ANTIC COLONIAL's AIRSLATE.

We work with it as a cement-based adhesive, but with the bonding, flexibility, and water resistance capabilities of a reactive resin adhesive. Professional use.



Certifications/Standards:
EN 12004 R2T

Characteristics:

- Two-component reactive resins adhesives.
- Unbeatable workability; same as that of any cement-based adhesive.
- Maximum adherence and excellent flexibility; more than 50 mm in transversal deformability.
- High wettability and long open time.
- Quick-drying: admits light traffic 6 hours after installation.
- Application thickness up to 15 mm.

Recommended use:

- Laying of wall tiles not compatible with cement-based adhesives
- Wall tiles on substrates not compatible with cement-based adhesives
- Floor tiles on deformable substrates
- Floor tiles with special chemical resistance
- Pools and damp environments, steam rooms and spas
- Stone sheets for wall coverings as AIRSLATE by L'ANTIC COLONIAL
- Laying of slate and other natural stones with risk of deformation by water absorption.

Substrates:

- Substrates in concrete and cement or anhydrite mortar.
- Slabs and cement mortar or gypsum rendering.
- Plasterboard and wood panels.
- Existing wall tiles*.
- Metal sheets.
- Surfaces painted with epoxy or polyurethane-based resins.

Materials:

- Large format ceramic tiles
- High-absorption ceramic tiles and stoneware
- Porcelain tiles
- XTONE and XLIGHT
- Glass mosaic
- Natural stone and marble not prone to staining
- Natural stone and marble prone to staining
- Slates and similar sensitive to contact with water
- AIRSLATE
- DQS and other marble agglomerate

Coverage:

- Small format and mosaic / Trowel U3: 2 kg/m²
- Medium format / Trowels U4: 2-3 kg/m²
- Large format / Trowels U6: 3-4 kg/m²

Regardless of our recommendations for use indicated for this adhesive, respect the installation regulations in force in each country.

Before using this product in any application not indicated in this catalogue, please perform a test or refer to the product's technical sheet.

politech Premium

SAP	Presentation	Europallet	P/EU
100217753	politech Premium can 10 kg	330 kg/pallet	8.51 p/kg

REACTIVE RESINS ADHESIVES

linkfloor fix

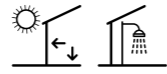

linkfloor fix is a solvent-free acrylic adhesive for lightweight floor coverings such as carpets, PVC, rubber or linoleum sheets, even on heavily trafficked floors. Its high performance and great versatility allow it to be used in all types of technical installations like sports venues, including walls. Professional use.

Especially recommended for installing Linkfloor floors from L'ANTIC COLONIAL.

Certifications / Standards:

IMO nautical certification

Features:

- Solvent- and odor-free adhesive
- Excellent adhesion and flexibility
- High initial grip, especially for wall applications
- Resistant to high traffic such as hospitals or airports
- Compatible with underfloor heating
- Suitable for the installation of new PVC sheets on existing PVC flooring

Recommended use:

- Non ceramic, indoor floor and wall coverings
- High traffic floor coverings.
- Floor coverings on radiant heating.

Substrates:

- Cement covered floors and walls.
- Concrete slabs.
- Plasterboards.
- Existing ceramic floor and wall coverings.
- Existing parquet floors.
- Existing PVC floors.
- On fire-resistant or water-resistant wood panels, apply super-prim

Materials:

- Decorative PVC Tiles (LVT).
- Homogeneous and multi-layer PVC (tiles or rolls).
- PVC on cork.
- Polyolefins.
- Linoleum in rolls.
- Expanded vinyls with relief.
- Semiflexible tiles.
- Carpets with or without backing.
- Carpets on foam (latex).
- Carpets with non-woven backing.
- Carpets with synthetic back (Action Back).
- Especially indicated for Linkfloor from L'ANTIC COLONIAL

Coverage:

- Wall tiles with smooth and non-embossed backs 200 – 250 gr/m²
- Wall tiles with rough backs 200 – 250 gr/m²

Regardless of our recommendations for use indicated for this adhesive, respect the installation regulations in force in each country.

Before using this product in any application not indicated in this catalog, please perform a test or refer to the product's technical sheet.

linkfloor fix

SAP		Presentation	Europallet	P/EU
100243761	linkfloor fix	can 20 kg	640 kg/pallet	9.69 p/kg





h-920

h-920 is a high-performance hybrid polymer adhesive and sealant. It polymerizes in contact with environmental humidity, becoming an elastomer with extraordinary elasticity and excellent adhesion. Free of isocyanates, silicones and solvents, provides a high grip since its application, on a wide variety of materials used in construction such as ceramic or porcelain tiles, natural stone, wood or metal. Professional use.

Especially recommended for the installation of L'ANTIC COLONIAL Linkfloor Infinity wall tiles.



ADHESIVES

Features:

- Hybrid polymer suitable as both adhesive and sealant.
- Maximum flexibility
- High mechanical performance
- Great initial grip; rapid skin formation and final curing.
- Excellent adhesion even on wet surfaces and immersion
- Resistant to UV radiation and atmospheric agents
- Paintable

Recommended applications:

- Interior and exterior coatings
- Direct stick adhesive, immediate hold.
- Elastic bonding in construction on galvanized sheets, ferrous or non-ferrous metals, plastic materials or polystyrene. Especially recommended for:
 - Installation of ventilated facades.
 - Installation of raised access floors
- Bonding Concept XPS panels.
- Sealing of movement joints in walls

Supports:

- All the usual supports for laying tiles

Materiales:

- Ceramic tiles and glass mosaic.
- Brick, concrete, exposed work, marble and natural stone.
- Wood panels.
- Concept XPS and other polystyrene panels.
- Metals such as aluminium, iron, zinc and galvanized.
- PVC and plastic materials.
- KRION and other types of solid surface.
- Especially suitable for Linkfloor infinity from L'ANTIC COLONIAL

Coverage:

- Approximately 2 m²/cartridge

Regardless of our recommendations for use indicated for this adhesive, respect the installation regulations in force in each country.

Before using this product in any application not indicated in this catalog, please perform a test or refer to the product's technical sheet.

h-920

SAP 100292915	h-920 white	Presentation cartridge 290 ml	Packaging 25 ud/box	P/EU 10.18 p/u
-------------------------	-------------	---	-------------------------------	---------------------------------

concealed facade fixings

Innovative concealed fixing clip for ceramic tiles in bonded facades. The fixings fit within small slots done on the porcelain piece and are anchored to the support by a stainless steel screw. Once the joints are grouted, the fixings are not visible anymore, not affecting the facade design.

These fixings have been designed as a security element in porcelain tile walls installed by the thin layer, double bonding method. We recommend the use of type C2S2 cement-based adhesives as per EN 12004.

As a general rule, we recommend this kind of fixing from a height corresponding to first concrete slab. In any case, standards in force must be observed for every project.



Features:

- 1.4301 (AISI 304 V2A) stainless steel clips.
- Suitable for 5 - 7 mm wide joints.
- Suitable for tiles 9 to 12 mm thick.
- Start fixings available in 40 and 80 mm lengths for overhanging installations.
- Includes stainless steel screw and plug.

Recommended uses:

- Laying of tiles in facades.
- Laying of ceramics in ceilings and cornices.
- Indoor laying of large format porcelain tiles at a certain height.

Materials:

- Large format ceramic tiles
- High-absorption ceramic tiles
- Porcelain tiles
- XTONE and XLIGHT

Substrates:

- Cement-based screeds

Coverage:

Coverage changes with every facade design. In the case of a regular facade with no gaps, clip calculation would be the following:

Tile cm	Type I fixings ud/m ²	Type A/T fixings ud/m ²
43,5 x 65,9	5,6	1,4
44 x 66	5,5	1,4
60 x 60	4,5	1,1
45 x 90	4,0	1,0
60 x 120	3,4	0,8
60 x 180	2,3	0,6

Before using this product in any application not indicated in this catalogue, please perform a test or refer to the product's technical sheet. Screws and plugs included

concealed facade fixings

SAP		Presentation	P/EU
100005743	minimum I joint	bag 50 ud	1.53 p/u
100005744	minimum A/T joint 4 cm	bag 50 ud	1.53 p/u
100005745	minimum A/T joint 8cm	bag 50 ud	1.70 p/u

visible facade fixings

Visible fixing clip for ceramic tiles in bonded facades. Fixings hold the ceramic tiles and are anchored to the support by a stainless steel screw. Once the joints are grouted, the fixings are visible, and a 5 mm clip can be seen.

These fixings have been designed as a security element in porcelain tile walls installed by the thin layer, double bonding method. We recommend the use of type C2S2 cement-based adhesives as per EN 12004.

As a general rule, we recommend this kind of fixing from a height corresponding to first concrete slab. In any case, standards in force must be observed for every project.



Features:

- 1.4301 (AISI 304 V2A) stainless steel clips.
- Suitable for 12 mm wide joints.
- Suitable for tiles 10 to 12 mm thick.
- Available in metallic or lacquered finish.
- Customizable color lacquering on demand.
- Includes stainless steel screw and plug.

Recommended uses:

- Laying of tiles in facades.
- Laying of ceramics in ceilings and cornices.
- Indoor laying of large format porcelain tiles at a certain height.

Materials:

- Large format ceramic tiles
- High-absorption ceramic tiles and stoneware
- Porcelain tiles
- XTONE and XLIGHT

Substrates:

- Cement-based screeds

Coverage:

Coverage changes with every facade design. In the case of a regular facade with no gaps, clip calculation would be the following:

Tile cm	100 fixing ud/m ²	1200 fixing ud/m ²
43,5 x 65,9	1,40	5,60
44 x 66	1,40	5,50
60 x 60	1,10	4,50
45 x 90	1,00	4,00
60 x 120	0,80	3,40
60 x 180	0,60	2,20

Before using this product in any application not indicated in this catalogue, please perform a test or refer to the product's technical sheet. Screws and plugs included

visible facade fixings

SAP	Fixing clip stainless	Presentation	P/EU
100005737	ref. 1000	bag 50 ud	1.53 p/u
100005739	ref. 1200	bag 50 ud	1.53 p/u

Selection tables for butech's adhesives

SELECTION OF ADHESIVE FOR RESIDENTIAL INDOOR FLOORING AND PUBLIC PEDESTRIAN PREMISES

Types of tiles (ISO 13006): BI_a / BI_b

Rectified tiles, Porcelain tiles, STON-KER, PAR-KER & URBATEK

Type of substrate	Length longest side of tile			
	≤ 300mm	≤ 600mm	≤ 900mm	> 900mm
Cement-based screed with radiant heating	C2	C2 S1		C2 S2
Cement-based screed without radiant heating	C1	C2		
Anhydrite screed with radiant heating*	C2	C2 S1		C2 S2
Anhydrite screed without radiant heating*	C1	C2		
Concrete slab or floor	C2		C2 S1	
Pre-existing tiles/mosaic/stones	C2			
Metal surfaces	R1		-	

* previous priming with C adhesives

SELECTION OF ADHESIVE FOR COMMERCIAL INDOOR FLOORING OR FOR INDUSTRIAL USE WITH MECHANICAL REQUIREMENTS

Types of tiles (ISO 13006): BI_a / BI_b

Rectified tiles, Porcelain tiles, STON-KER, PAR-KER & URBATEK

Type of substrate	Length longest side of tile			
	≤ 300mm	≤ 600mm	≤ 900mm	> 900mm
Cement-based screed with radiant heating	C2	C2 S1		C2 S2
Cement-based screed without radiant heating	C2		C2 S1	
Concrete slab or floor	C2		C2 S1	
Pre-existing tiles/mosaic/stones	C2		C2 S1	
Metal surfaces	R1		R2	-

SELECTION OF ADHESIVE FOR OUTDOOR FLOORING

Types of tiles (ISO 13006): BI_a

Rectified tiles, Porcelain tiles, STON-KER, PAR-KER & URBATEK

Type of substrate	Length longest side of tile			
	≤ 300mm	≤ 600mm	≤ 900mm	> 900mm
Cement-based screed without radiant heating	C2	C2 S1	C2 S2	
Concrete slab or floor	C2	C2 S1	C2 S2	
Pre-existing tiles/mosaic/stones	C2 S1	C2 S1	C2 S2	
Metal surfaces	R1		R2	-

SELECTION OF ADHESIVE FOR INDOOR WALLS

Types of tiles (ISO 13006): BI_a

Porcelain tiles, STON-KER, PAR-KER & URBATEK

Type of substrate	Length longest side of tile			
	≤ 300mm	≤ 600mm	≤ 900mm	> 900mm
Lime/cement-based plaster with radiant heating	C2 / D1	C2 S1		C2 S2
Lime/cement-based plaster without radiant heating	C1 / D1	C2		
Gypsum-based plaster with radiant heating*	C2 / D1	C2 S1		C2 S2
Gypsum-based plaster without radiant heating*	C1 / D1	C2		
Large-format ceramic brick	C1	C2		
Concrete	C2 / D1	C2	C2 S1	
Pre-existing tiles/mosaic/stones	C2		C2 S1	
Cement/fiber cement -based panels	C1 / D1	C2		C2 S1
Wood surfaces	C2 / D1 / R1	C2 S1 / R1		-
Plasterboard panels	C1 / D1	C2	C2 S1	-
Metal surfaces	R1		-	

* previous priming with C adhesives

Types of tiles (ISO 13006): BIII

Wall tiles, Rectified wall tiles

Type of substrate	Length longest side of tile			
	≤ 300mm	≤ 600mm	≤ 900mm	> 900mm
Lime/cement-based plaster with radiant heating	C2 / D1	C2 S1		C2 S2
Lime/cement-based plaster without radiant heating	C1 / D1	C1	C2	
Gypsum-based plaster with radiant heating*	C2 / D1	C2 S1		C2 S2
Gypsum-based plaster without radiant heating*	C1 / D1	C1	C2	
Large-format ceramic brick	C1	C1	C2	
Concrete	C1	C2	C2 S1	
Pre-existing tiles/mosaic/stones	C2		C2 S1	
Cement/fiber cement -based panels	C1 / D1	C2		C2 S1
Wood surfaces	C2 / D1 / R1	C2 S1 / R1		-
Plasterboard panels	C1 / D1	C2	C2 S1	-
Metal surfaces	R1		-	

* previous priming with C adhesives

SELECTION OF ADHESIVE FOR OUTDOOR WALLS AND CEILINGS

Types of tiles (ISO 13006): BI_a / BIII

Wall tiles, Rectified wall tiles, Porcelain tiles, STON-KER, PAR-KER & URBATEK

Type of substrate	Length longest side of tile			
	≤ 300mm	≤ 600mm	≤ 900mm	> 900mm
Lime/cement-based plaster	C2 S1	C2 S1	C2 S2	
Concrete	C2 S1	C2 S2		
Cement/fiber cement -based panels	C2 S1	C2 S2		-
Metal surfaces	R1		R2	-

Selection tables for butech's adhesives

Coverage tables for butech's adhesives depending on the notched trowel used

SELECTION OF ADHESIVE FOR WALL COVERINGS AND FLOORING WITH CERAMIC PLATES

Types of tiles (ISO 13006): Bla				
XTONE & XTONE Premium				
Type of substrate	No fiber		With fiber	
	≤ 70 cm	> 70 cm	≤ 70 cm	> 70 cm
Indoor flooring and wall	C2	C2 S1	C2 S1	C2 S2
Outdoor or heated flooring	C2 S2			
Facade	C2 S1	C2 S2	R2	
Highly deformable substrates	R2			

SELECTION OF ADHESIVE FOR FLOORING AND WALL COVERINGS WITH MOSAICS

Type of substrate	No mesh			With mesh		
	Vitreous & ceramics	Natural stone	Wood & metal	Vitreous & ceramics	Natural stone	Wood & metal
Indoor flooring and wall without presence of water	C2	C2 S1 F	R2	C2 S1	C2 S1 F	R2
Indoor flooring and wall with presence of water	C2 S1	C2 S1 F	R2	C2 S1	C2 S1 F	R2
Pools	C2 S2	C2 S2	-	-	-	-
Highly deformable substrates	R2			R2		

SELECTION OF ADHESIVE FOR FLOORING AND WALL COVERINGS WITH NATURAL STONE

Type of substrate	Stain resistant		Sensitive to stains		Slate and similar		DQS**
	≤ 600mm	> 600mm	≤ 600mm	> 600mm	≤ 300mm	> 300mm	
	Indoor flooring and wall without presence of water	C2	C2 S1	C2 F	C2 S1 F	C2 S1 F	
Indoor flooring and wall with presence of water	C2 S1	C2 S2	C2 S1 F	C2 S2 F	C2 S2 F	R2	-
Outdoor or heated flooring	C2 S2	C2 S2	C2 S2 F	C2 S2 F	C2 S2 F	R2	-
Pools	C2 S2	C2 S2	C2 S2 F	C2 S2 F	C2 S2 F	R2	-
Highly deformable substrates	R2						

* Meshed natural stone plates: Check with butech's Technical Department

** In floors with direct sunlight, use R2 adhesives

ADHESIVE COVERAGE (kg / m ²)	U3	U4	U6	U8	U10	U12	U10
Type of adhesive	3 x 3	4 x 4	6 x 6	8 x 8	10 x 10	12 x 12	R 10 x 10
tixocem plus		2-3	3-4	4-5	5-6		
flexitec n		2-3	3-4	4-5	5-6		
fr-one n		2-3	3-4	4-5	5-6	6-7	
one-flex premium		2-3	3-4	4-5	5-6	6-7	
super-one n		2-3	3-4	4-5	5-6	6-7	
super-flex s2		1-2	2-3	3-4	4-5	5-6	
rapimax n						6-7	6-7
maxifluid						6-7	6-7
politech n	1-2	2-3	3-4	4-5			
politech premium	1-2	2-3	3-4	4-5			

RECOMMENDED NOTCHED TROWEL	U3	U4	U6	U8	U10	U12	U10
Type of ceramics	3 x 3	4 x 4	6 x 6	8 x 8	10 x 10	12 x 12	R 10 x 10
mm x mm							
Wall tiles 316 x 200		x	x				
Wall tiles 316 x 446		x	x	x			
Wall tiles 316 x 592		x	x	x	x		
Wall tiles 316 x 900		x	x	x	x	x	
Wall tiles 450 x 1200		x		x	x	x	
PAR-KER 215 x 659		x	x	x	x		
PAR-KER 143 x 900		x		x	x		
PAR-KER 220 x 900		x		x	x		
PAR-KER 193 x 1200		x		x	x	x	x
PAR-KER 294 x 1200		x		x	x	x	x
PAR-KER 250 x 1500		x		x	x	x	x
PAR-KER 193 x 1800		x		x	x	x	x
PAR-KER 294 x 1800		x		x	x	x	x
URBATEK 297 x 596		x	x	x	x		
URBATEK 400 x 400		x	x	x	x		
STON-KER 443 x 443		x	x	x	x		
STON-KER 435 x 659		x		x	x	x	x
STON-KER 450 x 900		x		x	x	x	x
STON-KER / URBATEK 596 x 596		x		x	x	x	x
STON-KER / URBATEK 800 x 800		x		x	x	x	x
STON-KER / URBATEK 596 x 1200		x			x	x	x
STON-KER / URBATEK 1200 x 1200		x			x	x	x
XTONE 1000 x 3000	x	x		x	x	x	
XTONE Premium 1200 x 1200	x	x		x	x	x	
XTONE Premium 1200 x 2500	x	x		x	x	x	
XTONE Premium 1500 x 3200	x	x		x	x	x	
MOSAICS	x	x	x				
AIRSLATE 1200 x 2400		x	x				

x Recommended trowel with standard conditions



GROUTING MATERIAL AND ELASTIC SEALANTS

CEMENT-BASED MATERIALS FOR TILE JOINTS

colorstuk rapid n, **138** | colorstuk 0-4 n, **139** | colorstuk n especial, **140**

ADDITIVES FOR CEMENT-BASED JOINTS

cl-stuk, **141**

EPOXY GROUTING MATERIALS

epotech aqua, **142** | epotech nature, **143** | epotech crystal, **144**
epoxy cleaning kit, **145** | epotech cleaner, **145** | epoxy sponge, **145**

ELASTIC JOINT SEALANTS

s-107 n, **146** | s-502 n, **147** | p-404, **149**

LEVELING SYSTEM FOR CERAMIC TILES

self-leveling spacers, **150**

colorstuk rapid n

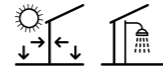

colorstuk rapid n is a type CG2 WA high-performance, cement-based grouting material as per EN 13888, for grouting joints up to 15 mm. Suitable for all kinds of ceramic tiles and natural stone, it is specially recommended for outdoor applications and permanently damp environments .

A high-tech, fine grained colored mortar with fast setting and hardening times for grouting tile joints up to 15 mm. Suitable for all kinds of ceramic tiles and natural stone. Indoors and outdoors.



Certifications/Standards:
EN 13888 CG2 WA

Features:

- Cement-based, single-component, colored mortar.
- Fine texture mortar for grouting tile joints up to 15 mm.
- Mortar with fast setting and hardening times.
- It prevents efflorescences.
- Excellent mechanical resistance.
- Resistant to heat and UV radiation.
- Frost-resistant.
- Waterproof mortar.
- Anti-mold action.
- Easy to apply and clean.
- Wide color range.
- Mixing water: colorstuk rapid n 1,1 l per 5 kg bag.

Recommended uses:

- Tile joints up to 15 mm.
- Indoor wall and floor tiles.
- Outdoor floors and terraces.
- High traffic floor tiles.
- Floor tiles on radiant heating.
- Pools and damp environments.
- Outdoor wall tiles in facades.

Substrates:

- All usual substrates for ceramic tiles laying.

Coverage:

- See the grouting materials table on page 152

Materials:

- Absorbent and non-absorbent ceramic tiles, including porcelain tiles.
- Tiles with mosaic-like patterns.
- Glass mosaic.
- Clay and terracotta tiles.
- Natural stone and marble not prone to staining.

colorstuk rapid n

SAP		Presentation	Europallet	P/EU
100236463	blanco	bag 5 kg	400 kg/pallet	2.95 p/kg
100275760	perla	bag 5 kg	400 kg/pallet	3.24 p/kg
100236834	gris	bag 5 kg	400 kg/pallet	3.02 p/kg
100236808	beige	bag 5 kg	400 kg/pallet	3.61 p/kg
100236794	marfil	bag 5 kg	400 kg/pallet	3.56 p/kg
100236833	caramelo	bag 5 kg	400 kg/pallet	3.15 p/kg
100236809	marron	bag 5 kg	400 kg/pallet	3.01 p/kg
100236823	tabaco	bag 5 kg	400 kg/pallet	4.37 p/kg
100236824	moka	bag 5 kg	400 kg/pallet	2.76 p/kg
100236464	manhattan	bag 5 kg	400 kg/pallet	2.50 p/kg
100236449	cemento	bag 5 kg	400 kg/pallet	2.46 p/kg
100236481	antracita	bag 5 kg	400 kg/pallet	2.53 p/kg
100236475	negro	bag 5 kg	400 kg/pallet	3.01 p/kg

Colors shown are approximate. There are physical samples available to customers for checking the real grout color.

Before using this product in any application not indicated in this catalogue, please perform a test or refer to the product's technical sheet.

colorstuk 0-4 n

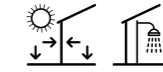

colorstuk 0-4 n is a type CG2 WA fine grain grouting material as per EN 13888, for grouting joints up to 4 mm. It is easy to apply, resistant and color stable, and it is specially recommended for rectified tiles.

A high-tech, fine grained colored mortar for grouting tile joints from 0 to 4 mm. Suitable for all kinds of ceramic tiles and natural stone. Indoors and outdoors.



Certifications/Standards:
EN 13888 CG2 WA

Features:

- Cement-based, single-component, colored mortar.
- Fine texture mortar for grouting tile joints up to 4 mm.
- Easy to apply and clean.
- Resistant to heat and UV radiation.
- Frost-resistant.
- Wide color range.
- Mixing water:
colorstuk 0-4 n white 1,6-1,8 l per 5 kg bag.
colorstuk 0-4 n white 1,2-1,3 l per 5 kg bag.

Substrates:

- All usual substrates for ceramic tiles laying.

Coverage:

- See the grouting materials table on page 152

Recommended uses:

- Tile joints up to 4 mm.
- Indoor wall tile coverings. Specially recommended for rectified tiles.
- Indoor floor tiles, including public buildings.

In the following applications, replace mixing water by cl-stuk additive:

- Outdoor floors.
- High traffic floor tiles.
- Floor tiles on radiant heating.
- Pools and damp environments.

Materials:

- Absorbent and non-absorbent ceramic tiles, including porcelain tiles.
- Glass mosaic.
- Natural stone and marble not prone to staining.

In the following applications, replace mixing water by cl-stuk additive:

- Wall tiles with mosaic-like patterns.
- DQS slabs and other kinds of marble agglomerate.

colorstuk 0-4 n

SAP		Presentation	Europallet	P/EU
100236442	blanco	bag 5 kg	400 kg/pallet	1.42 p/kg
100275725	perla	bag 5 kg	400 kg/pallet	1.73 p/kg
100236806	gris	bag 5 kg	400 kg/pallet	1.69 p/kg
100236419	beige	bag 5 kg	400 kg/pallet	1.79 p/kg
100236480	marfil	bag 5 kg	400 kg/pallet	1.73 p/kg
100236446	marrón	bag 5 kg	400 kg/pallet	1.73 p/kg
100236807	moka	bag 5 kg	400 kg/pallet	1.65 p/kg
100236461	manhattan	bag 5 kg	400 kg/pallet	1.73 p/kg
100236462	cemento	bag 5 kg	400 kg/pallet	1.73 p/kg
100236409	antracita	bag 5 kg	400 kg/pallet	1.73 p/kg
100236472	negro	bag 5 kg	400 kg/pallet	1.73 p/kg

Colors shown are approximate. There are physical samples available to customers for checking the real grout color.

Before using this product in any application not indicated in this catalogue, please perform a test or refer to the product's technical sheet.

colorstuk especial n

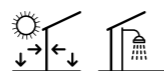

colorstuk especial n is a type CG2 WA very fine grain grouting material as per EN 13888, for grouting joints up to 4 mm. Its formula includes ultrafine aggregates, which make it specially recommended for tiles with a glaze sensitive to scratching.

A high-tech, fine grained colored mortar for grouting tile joints up to 4 mm. Specially recommended for grouting rectified ceramic tiles sensible to scratching, and ceramic parquet flooring



Certifications/Standards:
EN 13888 CG2 WA

Features:

- Cement-based, single-component, colored mortar.
- Ultrafine aggregates formula.
- Fine texture mortar for grouting tile joints up to 4 mm.
- Easy to apply and clean.
- Resistant to heat and UV radiation.
- Frost-resistant.
- Wide special colors range.
- Mixing water:
colorstuk especial n 0,64 l per 2 Kg bag.

Substrates:

- All usual substrates for ceramic tiles laying.

Coverage:

- See the grouting materials table on page 152

Recommended uses:

- Tile joints up to 4 mm.
- Ceramic tiles with low hardness glaze as per Mohs scale.
- Indoor wall tile coverings. Specially recommended for rectified tiles.
- Indoor floor tiles, including public buildings.

In the following applications, replace mixing water with **cl-stuk** additive:

- Wall and floor tiles into direct contact with water.
- Floor tiles on radiant heating.

Materials:

- Absorbent and non-absorbent ceramic tiles.
- Ceramic tiles with special finishes.
- Glass mosaic.
- Natural stone and marble not prone to staining.
- Do not use on polished materials.

In the following applications, replace mixing water by **cl-stuk** additive:

- Wall tiles with mosaic-like patterns.
- DQS slabs and other kinds of marble agglomerate.

colorstuk especial n

SAP	Color	Presentation	Europallet	P/EU
100238236	white	bag 2 kg	432 kg/pallet	5.72 p/kg
100238229	vainilla	bag 2 kg	432 kg/pallet	5.72 p/kg
100204255	oak	bag 2 kg	432 kg/pallet	2.64 p/kg
100204261	honey	bag 2 kg	432 kg/pallet	2.69 p/kg
100243281	iroko	bag 2 kg	432 kg/pallet	5.84 p/kg
100234451	elm	bag 2 kg	432 kg/pallet	2.85 p/kg
100243271	maple	bag 2 kg	432 kg/pallet	4.62 p/kg
100204254	beech	bag 2 kg	432 kg/pallet	2.58 p/kg
100238261	moka	bag 2 kg	432 kg/pallet	5.72 p/kg
100234433	wenge	bag 2 kg	432 kg/pallet	4.10 p/kg
100204260	doussie	bag 2 kg	432 kg/pallet	2.81 p/kg
100238235	nacare	bag 2 kg	432 kg/pallet	5.94 p/kg
100238260	graphite	bag 2 kg	432 kg/pallet	8.34 p/kg
100204245	ash	bag 2 kg	432 kg/pallet	2.58 p/kg
100204554	antracita	bag 2 kg	432 kg/pallet	2.88 p/kg
100238251	dark	bag 2 kg	432 kg/pallet	8.40 p/kg

Colors shown are approximate. There are physical samples available to customers for checking the real grout color.

cl-stuk

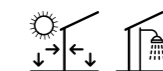

cl-stuk is a latex which mixed with cement-based grouts like colorstuk, reduces water absorption and enhances mechanical resistance and deformability. Specially recommended when laying ceramic outdoors and in permanently damp environments.

A latex additive that can be mixed with the colorstuk range of high-tech grout mortars in cases when increased mechanical resistance, reduced water absorption or improved flexibility is required.



Features:

- Water-based acrylic resins latex.
- Resistant to the most common chemicals.
- It reduces mortar water absorption.
- It enhances the adherence and deformability of the grouting material.
- It increases resistance to abrasion.
- Excellent resistance to UV rays and the effect of heat.
- Frost-resistant.

Coverage:

Product	%	Liters	Kg/bag
colorstuk 0-4 n white	34 %	1,6 - 1,8	5
colorstuk 0-4 n color	26 %	1,2 - 1,4	5
colorstuk especial n	32 %	0,64	2

Recommended uses:

- Specially recommended in:
- Outdoor floor and wall tiles.
 - High traffic floor tiles.
 - Floor tiles on radiant heating.
 - Pools and damp environments.

It enhances grouting material performance in:

- Indoor wall tile coverings. Specially recommended for rectified tiles.
- Indoor floor tiles, including public buildings.

Materials:

Specially recommended in:

- Wall tiles with mosaic-like patterns.
- DQS slabs and other kinds of marble agglomerate.

It enhances grouting material performance in:

- Absorbent and non-absorbent ceramic tiles, including porcelain tiles.
- Glass mosaic.
- Natural stone and marble not prone to staining.

cl-stuk

SAP	Presentation	Europallet	P/EU
100004374	cl-stuk can 2 kg	448 kg/pallet	5.27 p/kg
100004375	cl-stuk can 5 kg	480 kg/pallet	4.20 p/kg

Before using this product in any application not indicated in this catalogue, please perform a test or refer to the product's technical sheet.

epotech aqua

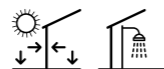

epotech aqua is a new line of epoxy putties for grouting tile joints. Two-component epoxy putty with no organic solvents. It is waterproof, it has outstanding chemical and mechanical properties and it is easy to apply. Specially recommended for application on mosaics and ceramic tiles with relief.

This material is suitable for grouting joints from 0 to 10 mm in floor and wall tiles, indoors and out. Excellent resistance to chemicals. Suitable for pools and permanently damp environments. Suitable as high adherence grouting material for ceramic tiles with any absorption level and format, for glass mosaic or natural stone.

Features:

- Two-component colored epoxy putty.
- Easy to apply and clean. This product is free of organic solvents and plasticizers
- Excellent joint color stability.
- Resistance to most chemicals and alkali, even in high concentrations.
- Waterproof joint, no water absorption.
- Excellent adherence and mechanical resistance.
- Tile joints up to 10 mm.
- Wide color range.

Recommended use:

- Tile joints with uniform color and shade, resistant to the passing of time.
- Floorings with built-in heating.
- Pools and damp environments.
- High traffic floor tiles
- Outdoor floorings protected against the presence of rising moisture
- Floorings and wall coverings in direct contact with chemicals. See technical sheet.

Substrates:

- All usual substrates for ceramic tiles laying.

Coverage:

- See the grouting materials table on page 152

Materials:

- Absorbent and non-absorbent ceramic tiles, including porcelain tiles.
- Tiles with mosaic-like patterns. Please refer to PORCELANOSA catalogues.
- Glass mosaic.
- Natural stone and marble not prone to staining.

epotech aqua					
SAP			Presentation	Europallet	P/EU
100182223	blanco		can 1,5 kg	315 kg/pallet	15.77 p/kg
100182217	marfil		can 1,5 kg	315 kg/pallet	15.52 p/kg
100278474	tabaco		can 1,5 kg	315 kg/pallet	15.77 p/kg
100182222	beige		can 1,5 kg	315 kg/pallet	15.52 p/kg
100182208	gris		can 1,5 kg	315 kg/pallet	15.52 p/kg
100278467	manhattan		can 1,5 kg	315 kg/pallet	15.77 p/kg
100278329	cemento		can 1,5 kg	315 kg/pallet	15.77 p/kg
100182213	antracita		can 1,5 kg	315 kg/pallet	15.52 p/kg
100278500	negro		can 1,5 kg	315 kg/pallet	15.77 p/kg

Colors shown are approximate. There are physical samples available to customers for checking the real grout color.

Before using this product in any application not indicated in this catalogue, please perform a test or refer to the product's technical sheet.

epotech nature

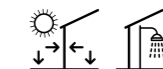

epotech nature is a new micro grain porcelain grout for the sealing of joints in ceramic tiles with designs inspired by nature. It has been specially developed for porcelain tiles that reproduce the appearance and texture of wood, such as PORCELANOSA Group's PAR-KER. Professional use.

This material is suitable for grouting tile joints up to 5 mm. in floorings and wall coverings, both indoors and outdoors. Excellent resistance to chemicals. Suitable for pools and permanently damp environments. Suitable as high adherence grouting material for ceramic tiles with any absorption level and format, for glass mosaic, or natural stone.

Characteristics:

- Two-component colored epoxy putty.
- Easy to apply and clean. This product is free of organic solvents and plasticizers.
- Excellent joint color stability.
- Resistance to most chemicals and alkali, even in high concentrations.
- Waterproof joint, no water absorption.
- Excellent adherence and mechanical resistance. Hypoallergenic and bacteriostatic.
- Tile joints up to 5 mm.
- Wide range of colors inspired by natural woods.

Recommended use:

- Floorings and wall coverings in natural wood-inspired ceramics.
- Tile joints with uniform color and shade, resistant to the passing of time.
- Floorings with built-in heating.
- Pools and damp environments.
- High traffic floor tiles
- Outdoor floorings protected against the presence of rising moisture
- Floorings and wall coverings in direct contact with chemicals. See technical sheet.

Substrates:

- All usual substrates for laying ceramic tiles.

Coverage:

- See the grouting materials table on page 152

Materials:

- Ceramic tiles with designs inspired by nature
- Absorbent and non-absorbent ceramic tiles, including porcelain tiles.
- Tiles with mosaic-like patterns. Please refer to PORCELANOSA catalogues.
- Glass mosaic.
- Natural stone and marble not prone to staining.

epotech nature					
SAP			Presentation	Europallet	P/EU
100177504	ash		can 1,5 kg	315 kg/pallet	18.57 p/kg
100177514	maple		can 1,5 kg	315 kg/pallet	18.57 p/kg
100177494	beech		can 1,5 kg	315 kg/pallet	18.57 p/kg
100204262	honey		can 1,5 kg	315 kg/pallet	18.57 p/kg
100177484	oak		can 1,5 kg	315 kg/pallet	18.57 p/kg
100177505	iroko		can 1,5 kg	315 kg/pallet	18.57 p/kg
100177513	elm		can 1,5 kg	315 kg/pallet	18.57 p/kg
100177512	doussie		can 1,5 kg	315 kg/pallet	18.57 p/kg
100177485	wenge		can 1,5 kg	315 kg/pallet	18.57 p/kg

Colors shown are approximate. There are physical samples available to customers for checking the real grout color.

Before using this product in any application not indicated in this catalog, please carry out a test or refer to the product's technical sheet.

epotech crystal

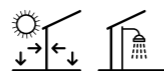

epotech crystal is an epoxy putty for grouting tile joints. Two-component putty with a translucent finish. It reflects the color of the tile or mosaic surrounding the joint. It features all the properties of epoxy putties: watertightness, high resistance to chemicals and mechanical properties. Specially recommended for application on mosaics and ceramic tiles with relief. Extra fine, micro grain porcelain grout.

This material is suitable for grouting joints up to 5 mm in floor and wall tiles indoors. Excellent resistance to chemicals in high concentrations. Suitable for permanently damp environments.



Certifications/Standards:

EN 13888 RG

Features:

- Extra fine, micro grain porcelain grout.
- Easy to apply and clean epoxy putty.
- Translucent appearance.
- High resistance to most acids and alkali, even in high concentrations.
- Waterproof joint, no water absorption.
- Excellent adherence and mechanical resistance.
- Prevents the development of fungi and bacteria.
- Tile joints up to 5 mm.

Recommended uses:

- Wall and floor tiles with minimum joint.
- Indoor floor and wall tiles.
- Mosaic or natural stone wall coverings.
- Wall tiles and mosaics with glass elements.
- PAR-KER floor coverings.
- Technical, porcelain floor coverings.

Substrates:

- All usual substrates for ceramic tiles laying.

Coverage:

- See the grouting materials table on page 152

Materials:

- Absorbent and non-absorbent ceramic tiles, including porcelain tiles.
- Glass mosaic.
- Wall tiles and mosaics with glass elements.
- Natural stone and marble not prone to staining.

epotech crystal			
SAP	Presentation	Europallet	P/EU
100126899	can 3 kg	295 kg/pallet	17.79 p/kg

Epoxy cleaning kit

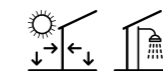

Cleaning kit for epoxy joint remains before their final hardening. It includes an epotech cleaner bottle, water-based detergent for cleaning off epoxy putties remains and stains..

It includes:

- 1 MMC handle epotech trowel
- 1 Epoxy sponge
- 1 Float for final cleaning + 3 scourers
- 1 200 ml epotech cleaner bottle



Epoxy cleaning kit	
SAP	P/EU
100113684	68.11 p/kit

epotech cleaner

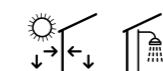

Water-based detergent for cleaning epoxy putties remains and stains. Specially recommended for cleaning remains of epotech aqua. Professional use.

Recommended uses:

- Cleaning of epoxy putties remains and films on ceramic tiles, glass mosaics and natural stones.



epotech cleaner		
SAP	Presentation	P/EU
100120428	bottle 500 ml	19.40 p/u

Epoxy sponge



Cellulose cleaning sponge for epoxy joints

- Cleaning epoxy joints
- 100% vegetable cellulose sponge
- 1 unit



Esponja epoxy	
SAP	P/EU
100085287	9.12 p/u

s-107 n

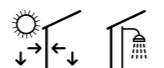

s-107 n is a neutral silicone putty for sealing joints. Specially recommended for sealing movement joints. Indoor and outdoor use.

This putty crosslinks in contact with dampness and does not give off odors, thus becoming an elastomer highly elastic and resistant to atmospheric agents.



Features:

- Single-component neutral silicone.
- High elasticity.
- Good adherence.
- Resistant to UV rays.
- Frost-resistant.

Recommended uses:

- Sealing joints even between materials sensible to chemical attack.
- Sealing movement joints in floors and walls.
- Sealing joints in ceramics, glass, metal and plastics.
- Sealing perimeter joints in wall tile coverings.
- Gluing ceramic materials on wood boards.

Substrates:

- All usual substrates for ceramic tiles laying.

Coverage:

- Joint de 2 x 2 mm 75.0 m
- Joint de 3 x 3 mm 33.3 m
- Joint de 5 x 3 mm 20.0 m
- Joint de 5 x 5 mm 12.0 m
- Joint de 8 x 4 mm 8.3 m

$$\text{Coverage (ml/cartridge)} = \frac{300}{\text{joint width (mm)} \times \text{joint depth (mm)}}$$

s-107 n					
SAP			Presentation	Packaging	P/EU
100005814	blanco		cartridge 300 ml	25 ud/box	6.35 p/u
100005815	transparente		cartridge 300 ml	25 ud/box	6.35 p/u
100120621	marfil		cartridge 300 ml	25 ud/box	7.57 p/u
100120624	tabaco		cartridge 300 ml	25 ud/box	7.57 p/u
100115950	beige		cartridge 300 ml	25 ud/box	6.35 p/u
100005816	gris		cartridge 300 ml	25 ud/box	6.35 p/u
100120620	cemento		cartridge 300 ml	25 ud/box	7.57 p/u
100120608	antracita		cartridge 300 ml	25 ud/box	7.57 p/u
100005817	negro		cartridge 300 ml	25 ud/box	6.35 p/u

Before using this product in any application not indicated in this catalogue, please perform a test or refer to the product's technical sheet. Colors shown are approximate. There are physical samples available to customers for checking the real grout color.

s-502

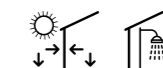

s-502 is a high-performance acetic silicone putty for sealing joints. Specially recommended for sealing joints in bathrooms and for sealing perimeter joints in wall tile coverings. It has anti-fungal properties that prevent the appearance of black spots in damp environments.

This reticular putty, when in contact with dampness gives off acetic acid, thus becoming an extraordinary elastic and resistant elastomer to atmospheric agents. Indoor use.



Features:

- Single-component acetic silicone.
- High elasticity. Can withstand movements up to 20% of the sealed joint width.
- Excellent adherence.
- Resistant to UV rays.

Recommended uses:

- Sealing joints in ceramics, glass, metal, plastics and painted surfaces.
- Sealing joints between ceramic wall coverings and ceramic bathroom fixtures, bathtubs, showers, or countertops in kitchens and bathrooms.
- Sealing perimeter joints in wall tile coverings.
- Sealing glass and woodwork.
- Sealing and gluing bathroom elements such as screens and cabins.
- Gluing ceramic materials on wood boards.

Substrates:

- Do not use on substrates which are sensible to the action of acids:
- Screeds and floors with cement mortar.
- Concrete

Coverage:

- 2 x 2 mm joint 77,5 m
- 3 x 3 mm joint 31,4 m
- 5 x 3 mm joint 20,6 m
- 5 x 5 mm joint 12,4 m
- 8 x 4 mm joint 8,6 m
- 8 x 6 mm joint 6,4 m

$$\text{Coverage (ml/cartridge)} = \frac{310}{\text{joint width (mm)} \times \text{joint depth (mm)}}$$

s-502				
SAP		Presentation	Packaging	P/EU
100005809	transparente	cartridge 310 ml	24 ud/box	7.08 p/u
100005808	blanco	cartridge 310 ml	24 ud/box	7.77 p/u

Before using this product in any application not indicated in this catalogue, please perform a test or refer to the product's technical sheet.



p-404

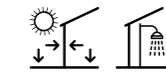

p-404 is polyurethane putty for sealing joints. Specially recommended for sealing movement joints outdoors. Indoor and outdoor use.,

This reticular putty in contact with dampness does not give off odors, thus becoming an extraordinary adherent, elastic and resistant elastomer to atmospheric agents.



Features:

- Single-component polyurethane putty.
- High elasticity.
- High adherence.
- Resistant to UV rays.
- Frost-resistant.

Recommended uses:

- Sealing joints even between materials sensible to chemical attack.
- Sealing movement joints in floors and walls.
- Bonding of building materials like ceramics, concrete, roof tiles, wood, aluminium, polyester or PVC.
- Gluing ceramic materials on metal or wood boards.
- Gluing Concept XPS panels.

Substrates:

- All usual substrates for ceramic tiles laying.

Materials:

- Ceramic tiles and glass mosaic.
- Glass.
- Metal.
- Plastic material, PVC.
- Concrete slabs.
- Wood.
- Concept XPS panels.

Coverage:

- 2 x 2 mm joint 77.5 m
- 3 x 3 mm joint 31.4 m
- 5 x 3 mm joint 20.6 m
- 5 x 5 mm joint 12.4 m
- 8 x 4 mm joint 8.6 m
- 8 x 6 mm joint 6.4 m

$$\text{Coverage (ml/cartridge)} = \frac{310}{\text{joint width (mm)} \times \text{joint depth (mm)}}$$

p-404		Presentation	Packaging	P/EU
SAP				
100005818	blanco	cartridge 310 ml	25 ud/box	6.77 p/u
100005819	gris	cartridge 310 ml	25 ud/box	6.77 p/u
100005820	negro	cartridge 310 ml	25 ud/box	6.98 p/u

Before using this product in any application not indicated in this catalogue, please perform a test or refer to the product's technical sheet.

self-leveling spacers

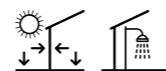

Leveling system for ceramic tiles. Eases ceramic tile laying and guarantees a perfectly flat surface of the final installation. The system consists of a new type of spacer with adjustable height that levels the surrounding tiles and prevents them from moving.

Specially recommended when tile, design or use features demand a perfect finish, with an even, seamless surface.

Features:

- Guarantees tiles are even.
- Prevents tiles from moving due to laying errors or due to mortar setting.
- Reduces retouching and laying times.
- Suitable for 0,5-3 mm wide joints.
- Suitable for floor and wall tiles of thickness between 7-15 mm. For thinner tiles use the supplementary lifting pieces
- The system consists of a spacer, a wedge and an adjusting tool.
- Wedges are recoverable, only the spacers are consumed.

Recommended uses:

- Wall and floor tiles with minimum joint.
- Large format floor tiles.
- Laying of rectified wall tiles.
- Tiles with reduced thickness: XLIGHT and XTONE
- Interlocking floor designs.
- Glued facades.
- Essential to place the ceramic by the method of thin layer and double gluing of the pieces

Substrates:

- All usual substrates for ceramic tiles laying.

Materials:

- Before using the self-levelling spacers system, carry out a preliminary test with the type of wall or floor tiles to be installed and check that the tile is not damaged during the removal of the spacer, especially in textured or rectified tiles without bevelling and mosaics with 3D texture

self-leveling spacers for tiles 3 to 15 mm thick

SAP		Presentation	Europallet	P/EU
100108031	wedge	100 ud/bag	700 bags/pallet	21.15 p/bag
100108032	wedge	300 ud/bag	240 bags/pallet	49.04 p/bag
100095383	wedge	500 ud/bag	140 bags/pallet	93.18 p/bag
100207811	0,5 mm spacer	100 ud/bag	600 bags/pallet	14.78 p/bag
100207797	0,5 mm spacer	300 ud/bag	200 bags/pallet	40.41 p/bag
100207740	0,5 mm spacer	500 ud/bag	120 bags/pallet	66.37 p/bag
100108026	1 mm spacer	100 ud/bag	600 bags/pallet	14.78 p/bag
100108027	1 mm spacer	300 ud/bag	200 bags/pallet	40.41 p/bag
100108028	1 mm spacer	500 ud/bag	120 bags/pallet	66.37 p/bag
100108029	2 mm spacer	100 ud/bag	600 bags/pallet	14.78 p/bag
100108030	2 mm spacer	300 ud/bag	200 bags/pallet	40.41 p/bag
100095382	2 mm spacer	500 ud/bag	120 bags/pallet	66.37 p/bag
100109070	3 mm spacer	100 ud/bag	600 bags/pallet	14.78 p/bag
100109071	3 mm spacer	300 ud/bag	200 bags/pallet	40.41 p/bag
100109072	3 mm spacer	500 ud/bag	120 bags/pallet	66.37 p/bag
100275166	5 mm spacer	100 ud/bag	600 bags/pallet	14.78 p/bag
100275156	5 mm spacer	300 ud/bag	200 bags/pallet	40.41 p/bag
100275138	5 mm spacer	500 ud/bag	120 bags/pallet	66.38 p/bag

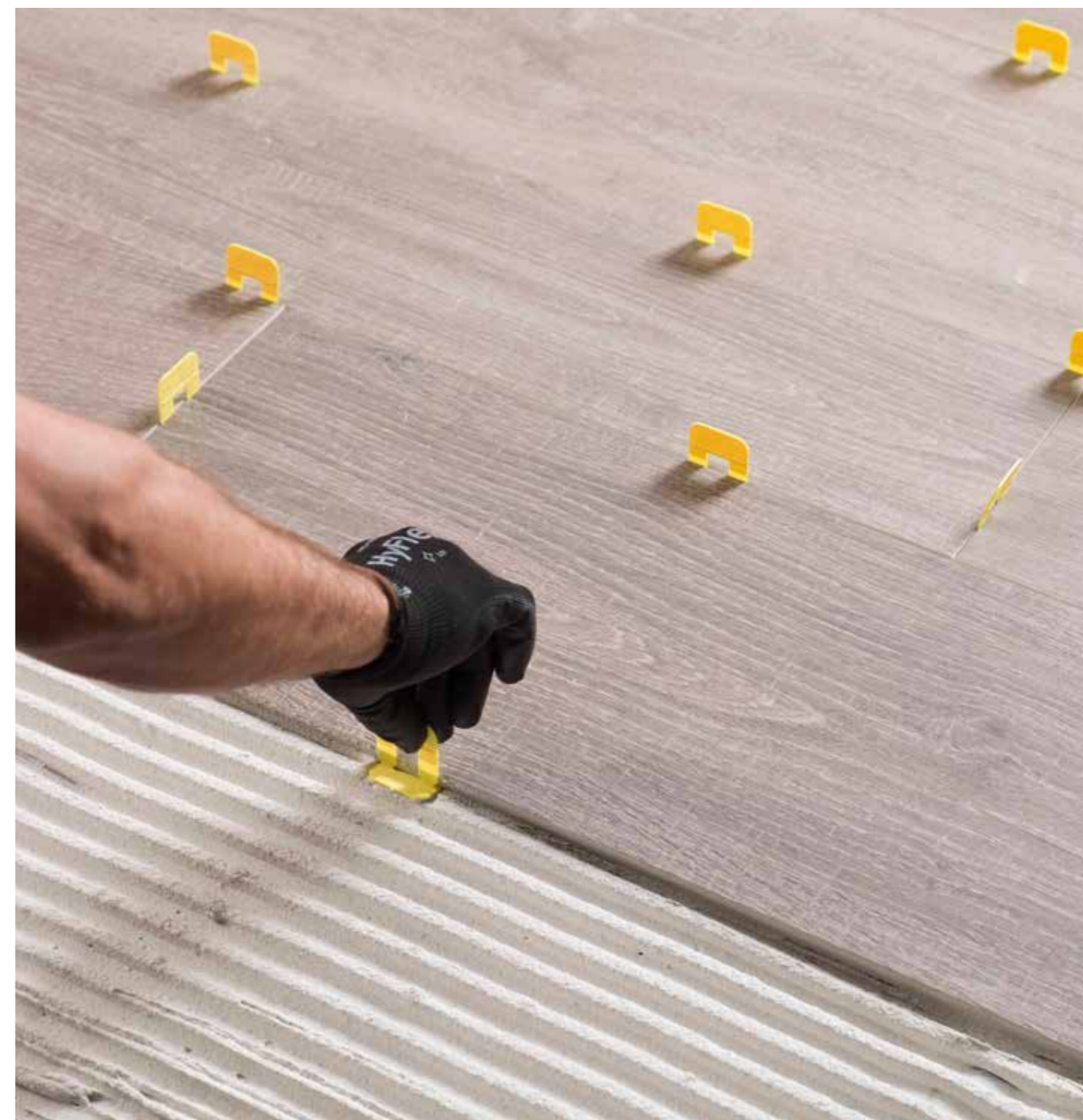

self-leveling spacers for tiles 16 to 22 mm thick

SAP		Presentation	P/EU
100225039	2 mm spacer	100 ud/bag	14.78 p/bag

complements			
SAP		Presentation	P/EU
100213808	0,5 mm spacer system kit	kit*	79.04 p/kit
100108034	1 mm spacer system kit	kit*	79.04 p/kit
100109073	2 mm spacer system kit	kit*	79.04 p/kit
100109074	3 mm spacer system kit	kit*	79.04 p/kit
100275157	5 mm spacer system kit	kit*	79.04 p/kit
100123264	supplementary lift piece	50 ud/bag	3.67 p/bag
100095386	adjustment tool	unit	49.91 p/u

*kit: 1 adjustment tool, 100 spacers and 100 wedges

GROUTING COVERAGE

a x b	c	colorstuk 0-4	colorstuk especial	colorstuk rapid	epotech aqua	epotech nature
cm	mm	gr/m ²	gr/m ²	gr/m ²	gr/m ²	gr/m ²
25 x 25	4	480	496	512	486	493
50 x 50	4	240	248	256	243	246
75 x 75	4	160	165	171	162	164
100 x 100	6	180	186	192	182	185
20 x 31,6	9	110	114	118	112	113
31,6 x 44,6	9	73	75	78	74	75
31,6 x 59,2	9	66	68	70	66	67
31,6 x 90	9	58	60	62	58	59
33,3 x 100	9,2	55	57	59	56	57
45 x 120	10,5	48	50	51	49	49
21,5 x 65,9	11	102	105	109	103	104
14,3 x 90	11	134	138	143	136	137
22 x 90	11	93	96	100	95	96
19,3 x 120	11	99	103	106	101	102
19,3 x 180	12	103	107	110	105	106
29,4 x 120	11	70	72	75	71	72
29,4 x 180	12	71	74	76	72	73
25 x 150	10,5	74	76	78	74	75
44,3 x 44,3	10	68	70	72	69	70
43,5 x 65,9	11	63	65	67	64	65
40 x 80	11	62	64	66	63	64
45 x 90	11	55	57	59	56	56
59,6 x 59,6	11	55	57	59	56	57
80 x 80	12	45	47	48	46	46
59,6 x 120	12	45	47	48	46	46
100 x 100	11	33	34	35	33	34
120 x 120	12	30	31	32	30	31
100 x 100	3,5	11	11	11	11	11
100 x 100	6	18	19	19	18	18
120 x 120	6	15	16	16	15	15
100 x 300	3,5	7	7	7	7	7
120 x 250	6	11	11	12	11	11

SELF-LEVELING SPACERS COVERAGE

a	b	a x b	c	Spacers / m ²	
				Aligned	Staggered 3/4
cm	cm	cm x cm	mm		
25	25	25 x 25	4	64	-
50	50	50 x 50	6	61	-
75	75	75 x 75	6	29	-
100	100	100 x 100	8	27	-
20	31,6	20 x 31,6	9	64	-
31,6	44,6	31,6 x 44,6	9	29	-
31,6	59,2	31,6 x 59,2	9	22	-
31,6	90	31,6 x 90	9	18	-
33,3	100	33,3 x 100	9,2	16	-
45	120	45 x 120	10,5	12	-
21,5	65,9	21,5 x 65,9	11	36	43
14,3	90	14,3 x 90	11	39	47
22	90	22 x 90	11	26	31
19,3	120	19,3 x 120	11	26	31
19,3	180	19,3 x 180	12	21	23
29,4	120	29,4 x 120	11	18	20
29,4	180	29,4 x 180	12	14	16
25	150	25 x 150	10,5	16	19
44,3	44,3	44,3 x 44,3	10	21	-
43,5	65,9	43,5 x 65,9	11	18	-
40	80	40 x 80	11	16	-
45	90	45 x 90	11	13	-
59,6	59,6	59,6 x 59,6	11	12	-
80	80	80 x 80	12	10	-
59,6	120	59,6 x 120	12	9	-
100	100	100 x 100	11	9	-
120	120	120 x 120	12	6	-
100	100	100 x 100	3,5	6	-
100	100	100 x 100	6	6	-
120	120	120 x 120	6	6	-
100	300	100 x 300	3,5	4	-
120	250	120 x 250	6	4	-



SUBSTRATE PREPARATION PRODUCTS

ELECTRIC RADIANT FLOOR HEATING

Electric Radiant Floor Heating, **157**

ACOUSTIC INSULATION

fonopac r, **159**

SELF-LEVELING MORTARS

level 1 pro, **160** | level 3, **161**

PRIMERS

super-prim, **162** | uniprim, **163**

CLEANING PRODUCTS

acid net 1L, **164** | porce-clean, **164** | basic-gel 1L, **164**
epotech cleaner, **165** | non slip tile, **165**



electric radiant floor heating

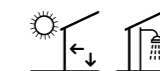

The electric radiant floor heating from butech, also known as **ERFH**, is a heating system with an electric element for radiant floors, specially designed to provide comfort in ceramic floors in bathrooms and, in general, all kinds of floors walked barefoot. The ERFH system consists of an electric element and a digital thermostat timer.

The electric element is a 1.8 mm diameter heating wire that transforms electric energy into heating. Never cut this kind of wire. Maximum power is 150 W/m².

User-friendly digital thermostat that regulates the turn on and off and heating power of the system.

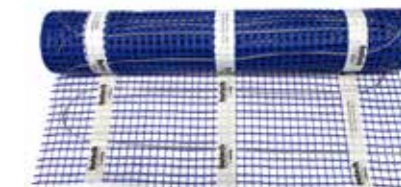

touch control

Features:

- Easy, quick and economic installation. No maintenance costs.
- Avoids the installation of radiators on the walls.
- Ideal for homes not connected to the gas distribution network.
- Applicable in floors where a water pipe heating cannot be installed.
- More uniform heat distribution to all the surface of the room.
- More pleasant elevation of heat distribution.
- No air movement.

Power: 150 W/m²
 Voltage: 230 V – 50/60 Hz
 Maximum charge: 16 Amp / 230 V max
 Maximum temperature: + 40°C

Installation:

- Choose the radiant Mat that suits the surface to be heated.
- In case of surfaces bigger than 10 m², connect Mats in parallel in a connection box.
- Do not connect Mats with a total surface bigger than 20 m² to one thermostat.
- Never cut the heating wire.
- Do not install under static elements and less than 10 cm from the walls.
- Never drill a floor where a radiant heating has been installed.

Recommended uses:

- Radiant heating in home refurbishings.
- General heating of homes.
- Comfort and auxiliary heating in bathrooms and dressing rooms.
- Comfort and auxiliary heating in spas and premises with permanent dampness.
- Comfort and auxiliary heating in locker rooms, recreational and sports premises.
- Heating of indoor areas with high ceilings.
- Temporary heating of workplaces.
- Do not use in outdoor floors.

Guarantee:

- Thermostat guarantee: 3 years
- Electric Mat guarantee: Lifetime

Materials:

- Absorbent ceramics and porcelain tiles (water absorption < 0.5% as per EN-ISO 10545-3).
- Natural stone and marble not prone to staining.
- Wooden floors bonded to the substrate.
- Do not use under floating floors.
- Do not use under material sensible to heat.

electric radiant floor heating

SAP	Premium ERFH	Presentation	P/EU
100232008	1 m ² Mat	1 Mat/box	148.99 p/u
100232081	1.5 m ² Mat	1 Mat/box	171.63 p/u
100232053	2 m ² Mat	1 Mat/box	191.28 p/u
100232009	2.5 m ² Mat	1 Mat/box	218.91 p/u
100232090	3 m ² Mat	1 Mat/box	244.50 p/u
100232082	4 m ² Mat	1 Mat/box	316.28 p/u
100232016	5 m ² Mat	1 Mat/box	387.09 p/u
100232080	10 m ² Mat	1 Mat/box	665.08 p/u
100232083	8GM Thermostat	1 thermostat/box	337.12 p/u

Before using this product in any application not indicated in this catalogue, please perform a test or refer to the product's technical sheet.



fonopac r



fonopac r is a multilayer sheet for isolating ceramic or natural stone floors against impact noise. Made of synthetic rubber, it combines a good Acoustic insulation with a low compressibility, allowing for direct laying of ceramic tiles. Specially recommended for refurbishing of floors.

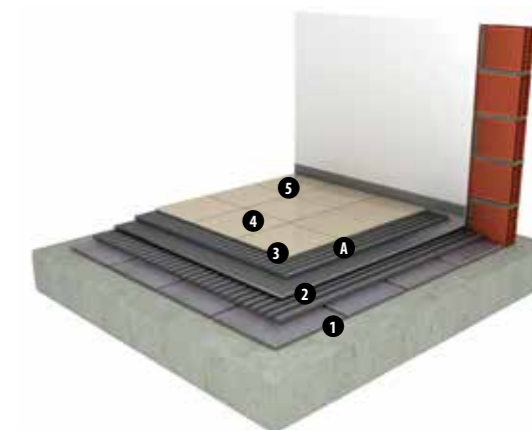

1- floor slab
2- old floor tile
3- fonopac r

4- floor tile
5- bandin
A- cement-based adhesive + unilax

Features:

- Sheet made of synthetic rubber and TPO..
- Allows direct laying of tiles, with no need for compression layers.
- Compatible with cement-based adhesives.

- Dimensions: 60 x 100 cm
- Final thickness: 3 mm
- Weight: 1,42 kg/m²

- Weighted reduction of impact sound pressure level according to standard ISO 717-2

$$\Delta L_w = 16 \text{ dB}$$

Installation:

- Cover the whole floor perimeter with acoustic isolating tape bandin.
- Laying of the sheets by the thin-bed method, with super-one n adhesive mixed with unilax.
- Seal the joints between sheets with cintex tape.
- Be extremely cautious when laying the sheet to avoid tears and other acoustic bridges.
- Once fonopac r sheets laid, lay the ceramic floor with super-one n mixed with unilax.

Recommended uses:

- Reduces impact noise in indoor floors.
- Reduces impact noise in refurbishing of floors.

Materials:

- Ceramic floors and similar products adhered to the substrate.
- Laminate floors.

Substrates:

- Cement covered floors.
- Existing floors.

fonopac r

SAP		Presentation	P/EU
100082628	fonopac r	sheets 100 x 60 cm	20.52 p/m ²
100004402	bandin	roll 30 m	18.84 p/roll
100004399	cintex	roll 50 m	24.26 p/roll
100004463	Kit fonopac r	Total 8,4 m ²	352.97 p/kit
	fonopac r	14x 100 x 60 cm sheets	
	super-one n	2x 25 Kg bags	
	bandin	1x 30 m roll	
	cintex	1x 50 m roll	

Before using this product in any application not indicated in this catalogue, please perform a test or refer to the product's technical sheet.

level 1 pro



level 1 pro is a fast hardening, self-leveling mortar for leveling and regularizing substrates for all kinds of floor tiles. Specially recommended for laying rectified ceramic floor tiles.

It is formulated for creating 2 to 10 mm floor substrates. It features good workability, fast-setting times, and a high mechanical performance. It allows to prepare floors well levelled, for a correct and quick fixing of rectified ceramic tiles.



Certifications/Standards:
EN 13813 CT-C20-F5

Features:

- Single-component, self-leveling mortar.
- Excellent adherence.
- Fast hardening. Ready for traffic in 4-5 hours.
- Application thickness between 2 and 10 mm.
- Easy application with a straight edge trowel or scraper. Pumpable.
- Indoor use.
- Mixing water. 6.0 l per 25 kg bag.

Recommended uses:

- Substrate regularization in refurbishing jobs.
- Indoor large format ceramic floor tile coverings.
- Indoor rectified floor tile coverings.
- Indoor floor tile coverings with a 1 mm joint.
- Laminate floating floors.
- Synthetic floors and carpet.
- Do not use in outdoor floors.
- Do not use on floors with radiant heating.

Substrates:

- For cement-based, concrete or anhydrite substrates, first apply **uniprim**.
- For existing ceramic substrates, first apply **super-prim**.

Materials:

- Large format ceramics.
- Porcelain tiles with a water absorption < 0.5% as per EN-ISO 10545-3.
- Natural stone and marble not prone to staining.
- Laminate floors and parquet.

Coverage:

Substrate	Coverage
Self-leveling floors	1.4 kg per m ² and thickness millimeter

level 1 pro				
SAP		Presentation	Europallet	P/EU
100141151	level 1 pro	bag 25 kg	1000 kg/pallet	0.85 p/kg

Before using this product in any application not indicated in this catalogue, please perform a test or refer to the product's technical sheet.

level 3



level 3 is a fast hardening, self-leveling mortar with fibres for leveling and regularizing substrates for all kinds of floor tiles. Specially recommended for laying ceramic floor tiles with a minimal joint indoors.

It is formulated for creating 3 to 30 mm floor substrates. It features good workability, fast-setting times, and a high mechanical performance. It allows to prepare floors well levelled, for a correct and quick fixing of rectified ceramic tiles.



Certifications/Standards:
EN 13813 CT C25-F5

Features:

- Compressive strenght ≥ 25 N/mm²
- Flexural strenght ≥ 5 N/mm²
- Single-component, self-leveling mortar.
- Excellent adherence. Flexible.
- High fibre content.
- Application thickness between 3 and 30 mm.
- Easy application with a straight edge trowel or scraper.
- Indoor use.
- Mixing water: 4.25 – 4.50 l per 25 kg bag

Recommended uses:

- Indoor large format floor tile coverings.
- Indoor large format rectified floor tile coverings.
- Indoor floor tile coverings with a 1 mm joint.
- Floor tiles with radiant heating.

Substrates:

- Cement-based substrate, previously apply **uniprim**.
- Glazed ceramic tiles and wood substrates, previously apply **super-prim**.

Materials:

- Large format floor tiles.
- Porcelain tiles (water absorption < 0.5% as per EN-ISO 10545-3).
- Natural stone and marbles.

Coverage:

Substrate	Coverage
Self-leveling floors	1.4 kg per m ² and thickness millimeter

level 3				
SAP		Presentation	Europallet	P/EU
100104577	level 3	bag 25 kg	1000 kg/pallet	1.35 p/kg

Before using this product in any application not indicated in this catalogue, please perform a test or refer to the product's technical sheet.

super-prim

super-prim is a water-based acrylic resin primer with silica arids, used for preparing substrates prior to using adhesives, self-leveling mortars and mortar screeds. It reduces water absorption and improves the consistency of cement-based substrates. Professional use.

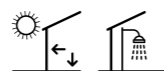

Features:

- Water-based, acrylic resin latex with silica arids.
- It enhances the adherence of cement mortars on glazed wall coverings.
- It improves the bonding material setting time.
- It reduces substrate water absorption.
- It increases cohesion of the substrate.
- Easy application with a paint roller or a wide paint-brush. Can be applied with airless spray.
- Indoor and outdoor use.
- Do not dilute with water or mix with any other liquids.

Recommended uses:

- Primer for self-leveling mortars on highly absorbent or existing ceramic tile coverings.
- Ceramic tiles on cement-based substrates with weak consistency or existing ceramic tile coverings.
- Ceramic floor coverings on anhydrite substrates or ceramic wall coverings on plaster or molding plaster.
- Mortar screeds on brick partition walls or concrete block walls.
- Mortar screeds on ceramic tile or natural stone floors.
- Do not use in substrates subject to dampness increases.

Substrates:

- Ceramic brick partition walls.
- Cement covered floors and walls.
- Concrete slabs and aerated concrete blocks.
- Anhydrite-covered floors and plastered walls.
- Indoor ceramic floor and wall tiles.
- Indoor wood boards.
- Indoor metal sheets.

Coverage:

Substrate	Coverage
Non absorbent	200 - 250 gr/m ²
Absorbent	250 -300 gr/m ²

super-prim				
SAP		Presentation	Europallet	P/EU
100123220	super-prim	can 10 kg	640 kg/pallet	9.47 p/kg

Before using this product in any application not indicated in this catalogue, please perform a test or refer to the product's technical sheet.

uniprim

uniprim is a water-based primer made of synthetic resins for the insulation of plaster, anhydrite and molding plaster substrates, prior to the use of cement-based adhesives. It reduces water absorption and improves the consistency of cement-based substrates

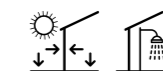

C2-type cement-based adhesives can be used to lay ceramic tiles quickly and efficiently on plaster, anhydrite and molding plaster substrates. It reduces the level of absorption of highly absorbent substrates, preventing cement-based adhesives from drying out too quickly and thus ensuring that they set properly. Priming prior to the application of self-leveling mortars on absorbent substrates, avoiding the appearance of bubbles or cracks because of a fast drying.

Features:

- Water-based synthetic resins primer.
- Once dry, it leaves a film over the substrate, which in plaster-based substrates prevents contact and chemical reaction with cement-based adhesives. It prevents ettringite buildup.
- It reduces substrate water absorption.
- It improves the bonding material setting time.
- It increases cohesion of the substrate.
- Easy application with a paint roller or a wide paint-brush.
- Indoor and outdoor use.

Recommended uses:

- Wall tiles on plaster or molding plaster substrates.
- Floor tiles on anhydrite substrates.
- Ceramic tiles on cement-based substrates with weak consistency.
- Reinforcement of self-leveling mortars.

Substrates:

- Plasterboards and plastered walls.
- Anhydrite floor coverings.
- Cement-based substrates with high water absorption.
- Plasterboards.
- Untreated partition walls for laying tiles.

Coverage:

Substrate	Coverage
Anhydrite/plaster substrate	100 - 200 gr/m ²

uniprim				
SAP		Presentation	Europallet	P/EU
100004384	uniprim	can 5 kg	480 kg/pallet	4.71 p/kg
100004387	uniprim	can 20 kg	560 kg/pallet	4.20 p/kg

Before using this product in any application not indicated in this catalogue, please perform a test or refer to the product's technical sheet.

acid net 1L

acid net is an acid detergent for cleaning ceramic floor and wall tiles. It dissolves all kinds of cement debris without damaging coverings or cement based joints like colorstuk.

Recommended uses:

- Cleaning of remains of adhesives and cement-based grouting materials in floor and wall tiles
- Cleaning of efflorescences and salts remains.
- Cleaning of plaster remains and plaster-based remains.
- Cleaning of lime remains and film.
- Cleaning of glazed substrates prior to laying new tiles.

Coverage:

Dilution 1: 1 with clear water 90-100 gr / m²
 Dilution 1: 2 with clear water 45-50 gr / m²



acid net 1L				
SAP		Presentation	Box	P/EU
100120423	acid net	bottle 1L	12 bottles	10.39 p/u

porce-clean

Neutral detergent for cleaning ceramic and natural stone floor coverings. High degreasing power for a deep and perfect cleaning. Fast drying. Indoor and outdoor use.

Recommended uses:

- Regular cleaning of ceramic wall tiles.
- Cleaning of remains of wax, oil or grease from floor and wall tiles .

Coverage:

10 l of clean water 100-200 ml



porce-clean				
SAP		Presentation	Box	P/EU
100120431	porce-clean	bottle 1L	12 bottles	9.26 p/u

basic gel 1L

Concentrated alkaline detergent developed for cleaning ceramic tiles in general. terracotta and antiqued marble. It removes all kinds of oils, varnishes, paints, wax and home stains. Specially effective for etching former treatments.

Recommended uses:

- Intensive cleaning of ceramic wall tiles.
- Cleaning of remains of wax, oil or grease from floor and wall tiles .
- Cleaning of glazed substrates prior to laying new tiles.



basic gel 1L				
SAP		Presentation	Box	P/EU
100120425	basic gel 1L	bottle 1L	12 bottles	12.39 p/u

*Given the wide variety of ceramic materials, glass mosaics and natural stones, we recommend to check with your tile provider about chemical resistance of the tiles before applying any cleaning product.

Before using any cleaning product, please perform a test or refer to the product's technical sheet.

epotech cleaner

Water-based detergent for cleaning epoxy putties remains and stains. Specially recommended for cleaning remains of epotech aqua. Professional use.

Recommended uses:

- Cleaning of epoxy putties remains and films on ceramic tiles, glass mosaics and natural stones.

Coverage for 2 mm joint:

Tile	200 x 316 cm	20 m ² /package
Tile	200 x 446 cm	30 m ² /package
Tile	316 x 596 cm	33 m ² /package
Tile	316 x 900 cm	37 m ² /package

epotech cleaner				
SAP		Presentation	Box	P/EU
100120428	epotech cleaner	bottle 500 ml	20 bottles	19.40 p/u



non-slip tile

Non-slip treatment for glazed and unglazed ceramic tiles reducing the risk of slip and fall accidents. Indoor and outdoor use.

The non-slip treatment reacts with the ceramic tiles surface, generating thousands of microscopic bowls. These evenly distributed engravings increase the contact surface and, in the presence of water, produce a suction between the covering and the foot. This effect increases the coefficient of friction and reduces the risk of slip and fall accidents.

Recommended uses:

- Glazed and non-glazed ceramic floor tile coverings.
- Indoor and outdoor floor tile coverings.
- Built in shower trays.
- Do not apply on fibre shower trays and bathtubs.
- Do not apply on materials which are sensible to acid attack, like limestones or mortar substrates.

Coverage:

Ceramic tile 200 gr/m²

non-slip tile				
SAP		Presentation	Box	P/EU
100120430	non-slip tile	bottle 500 ml	20 bottles	38.81 p/u

*Given the wide variety of ceramic materials, glass mosaics and natural stones, we recommend to check with your tile provider about chemical resistance of the tiles before applying any cleaning product.

Before using any cleaning product, please perform a test or refer to the product's technical sheet.



SHOWER TRAYS AND WATERPROOFING

SHOWER DECK SYSTEM

shower deck system, **168**

CONCEPT XPS SHOWER TRAYS

Concept xps shower trays, **170** | Standard shower trays, **172**

Refurbishing shower trays, **174** | Custom shower trays, **176**

Bespoke standard shower trays, **178** | Bespoke refurbishing shower trays, **180**

CONCEPT XPS PANELS

Concept xps panels, **182** | Fixing elements for concept xps panels, **183**

WATERPROOFING

imperband deck kit, **184** | imperband standard kit, **186**

Imperband refurbishing kit n, **187** | Linear grates, **188**

Squared grates, **192** | imperbox, **194** | Sylastic, **195** | Imperband, **196**

DRAINAGE

pool deck, **198** | Bathroom drain, **200** | Terrace drain, **201**

DECOUPLING

butech anti-cracking mat, **202** | lamitech n, **203**

SHOWER DECK SYSTEM

shower deck system



New shower tray concept with concealed drain for the most exclusive bathrooms. This innovative shower tray system lets us create a sense of continuity with the rest of the bathroom floor because the slopes are concealed under the floor. Drainage is achieved through the open joints and does not require the installation of an evacuation grid.

The **shower deck system** is a shower tray made up by a polyurethane base coated with thermoset polymers, especially designed to have ceramic plates installed. Specially recommended for bathroom renovations.

Features:

- Flat shower tray without slopes.
- Polyurethane base coated with thermoset polymers.
- Drain concealed from sight.
- Ultra-slim shower tray; only 30 mm in height.
- Easy to clean and high resistance to domestic-use detergents.
- Virtually no maintenance, especially compared with wooden floors.
- Thermal insulation.
- Easy installation and assembly.

Installation:

- Concrete floor slabs.
- Cement covered floors.
- Wood flooring.

Physical properties of the shower deck systems tray:

Color	Black
Weight	5 Kg/m ²
Compression resistance	2000 KpA
Capillarity	0
Limit application temperature.	-70/+130 °C
Supply thicknesses (mm)	30 mm
Tolerances	Length and width: ± 2 mm Thickness: +/- 2 mm Squaring: < 2 mm/m

Recommended use:

- Shower trays and cabins in designer bathrooms.
- Shower trays in public buildings.
- Applications where it is necessary to eliminate architectural barriers.
- Accessible bathrooms.

Materials:

- Anti-slip porcelain tile plates.
- STON-KER antislip
- PAR-KER antislip
- URBATEK antislip

Components:

- Shower deck tray
- Non-return valve drain. Output Ø 40mm and 0.52l/s
- 5 linear meters lami-band 200 roll
- Drain reinforcement piece
- P-404 tube
- Protection plate
- Manhole key
- PVC leveling profiles of 14X14X2000 mm to reference the height and finish of the ceramics (2 pcs)
- Profiles for union of ceramic pieces of 35 x 14 x longest measurement of the tray, max. 2000 mm (2 pcs)
- Ceramic tiles not included

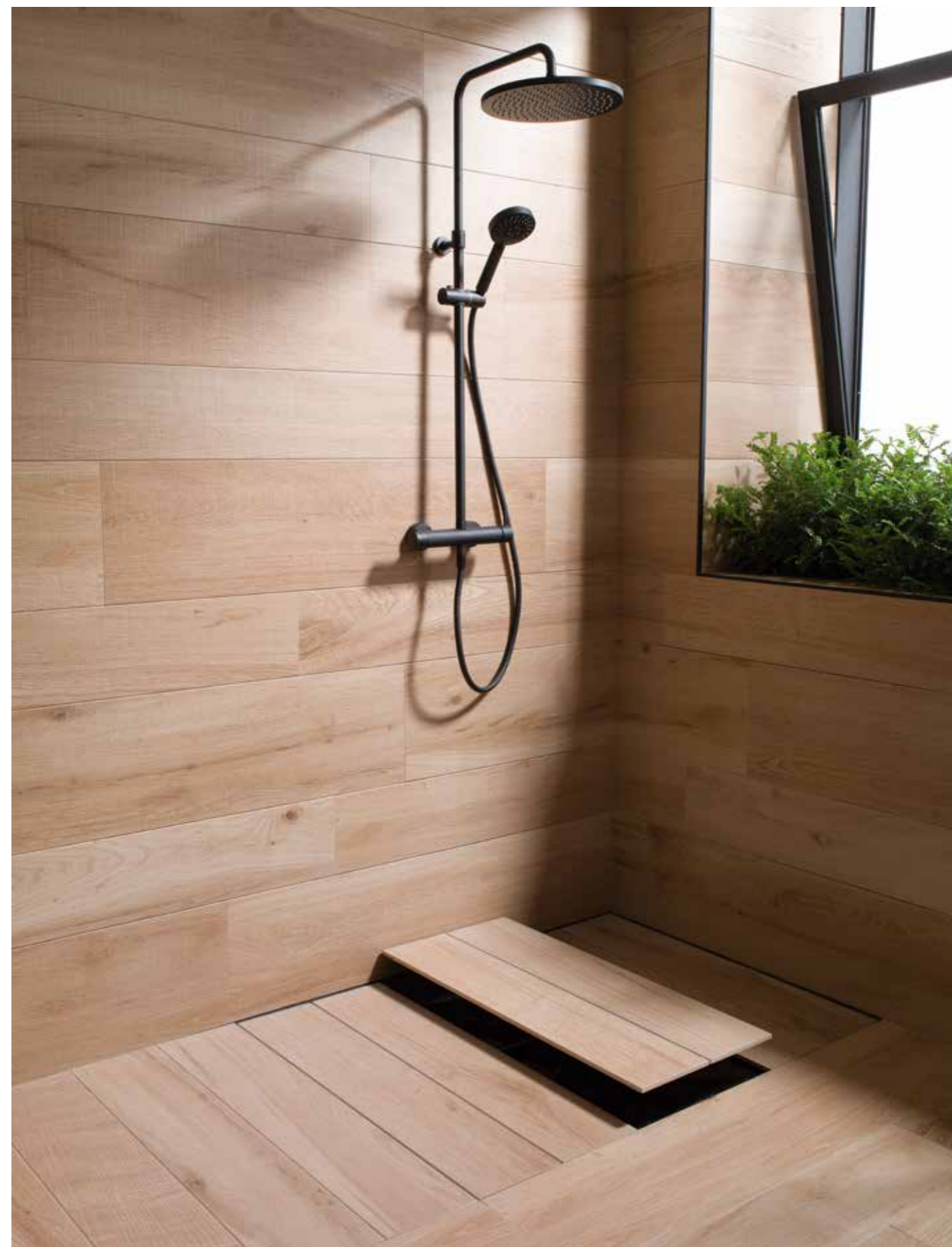

SHOWER TRAYS AND WATERPROOFING

shower deck system

SAP		Presentation	P/EU
100174849	700 x 700 x 30 mm	1 box	520.75 p/u
100175270	800 x 800 x 30 mm	1 box	581.95 p/u
100175271	800 x 938 x 30 mm	1 box	626.99 p/u
100175268	900 x 938 x 30 mm	1 box	665.26 p/u
100187136	1216 x 938 x 30 mm	1 box	786.22 p/u
100174848	Bespoke*	1 box	

drain

SAP		P/EU
250045810	horizontal swd drain	25.91 p/u
250049540	vertical horizontal swd drain	28.91 p/u
250049695	high flow swd drain + non-retirn valve	93.16 p/u

* Maximum shower tray dimensions 1.300 x 3.000 x 30 mm

CONCEPT XPS SHOWER TRAYS

concept xps shower trays

It is a prefabricated system for creating built in shower trays. They include the slopes for the correct water drainage, as well as the drain and the waterproofing system. This system is supplied ready to use, which reduces working times while guarantees a perfect substrate for laying mosaic, natural stone or ceramics.

concept xps shower tray is light, resistant and safe, reason why it is specially recommended in bathroom refurbishing jobs. It includes imperband kit as a drain and waterproofing system, but it does not include the decorative grating, so you can choose among a wide range of sizes, shapes and finishes.

Features:

- Prefabricated shower tray made of extruded polystyrene covered with cement mortar.
- It includes slopes for water drainage.
- Double waterproofing: covering consisting of waterproof mortar and imperband sheet.
- It includes imperband kit for waterproofing the shower tray and the adjustment piece.
- Available in two options:
 - imperband standard kit: 40 mm high
 - imperband refurbishing kit: 30 mm high
- Available for square as well as for linear drains.

- Compression resistance (10% DIN 3421 0.3 N / mm² crush risk):
- Initial thermal conductivity: DIN 2612 0.0336 W/m²K
- Flammability: DIN 4102 B1

Recommended uses:

- Specially designed for waterproofing built in showers.

Materials:

- Absorbent and non-absorbent ceramic tiles. Porcelain tiles with a water absorption < 0.5% as per EN-ISO 10545-3.
- Glass mosaic.
- Natural stone and marble not prone to staining.

Substrates:

- Concrete floor slabs.
- Cement covered floors.

concept shower tray selection guide

1. Depending on the drain outlet, select the type of concept xps shower tray to be used:

- Vertical outlet: Standard tray
- Horizontal outlet: Select depending on the shower tray height.

2. Depending on the shower tray height, select the type of concept xps tray to be used:

- 75-100 mm height Refurbishing shower tray
- > 100 mm height Standard shower tray

3. Select the type of decorative grating:

- Square grating: Shower tray for square grating
- Linear grating: Shower tray for linear grating

4. Select the grating position:

- ESQ: Grating on a corner.
- CENT: Grating in a central position.
- LAT: Grating in a lateral position.

5. Select the shower tray shape:

- Square shower tray.
- Rectangular shower tray.

6. Choose the shower tray among the available sizes.

In the case that the available sizes do not fit in the project needs, there is the possibility of making custom shower trays.



Standard shower trays for square grating

These shower trays feature a 40 mm thickness. It includes the imperband standard kit. Does not include the square grating.

concept xps shower trays



Square shower trays with square corner grating: ESQ

SAP		Presentation	P/EU
100103276	900 x 900 x 40 mm	Shower tray + Kit imperband	310.19 p/u
100103236	1000 x 1000 x 40 mm	Shower tray + Kit imperband	317.50 p/u

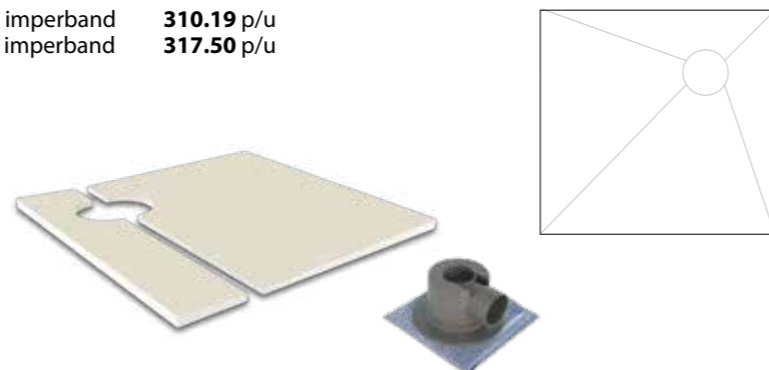

Rectangular shower trays with lateral square grid: LAT

SAP		Presentation	P/EU
100103251	900 x 1200 x 40 mm	Shower tray + Kit imperband	319.64 p/u
100103257	900 x 1400 x 40 mm	Shower tray + Kit imperband	344.52 p/u
100103267	900 x 1600 x 40 mm	Shower tray + Kit imperband	362.53 p/u
100108080	900 x 1800 x 40 mm	Shower tray + Kit imperband	512.65 p/u
100103247	1000 x 1200 x 40 mm	Shower tray + Kit imperband	312.16 p/u

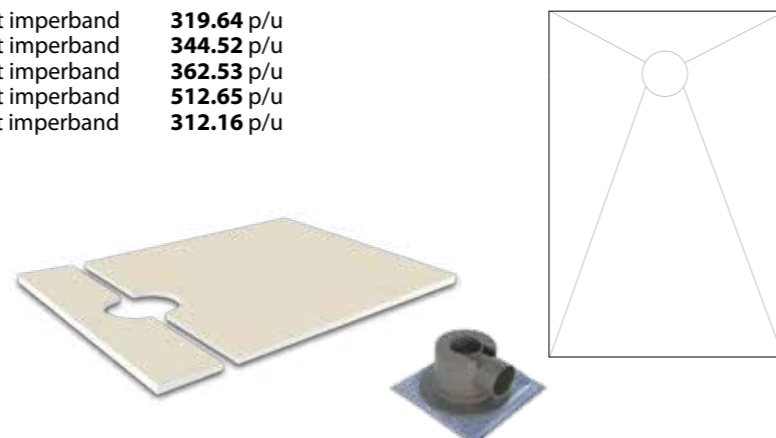

Square gratings

Information referring to squared gratings is on page 192 - 193.

SAP	Square grating
100148572	standard n squared
100114593	sun
100293010	square chrome
100293012	square tile

All the concept xps shower trays have available a 50 mm thickness special piece to increase the height of the shower tray and cover sewer and drain. Check conditions with your sales representative from PORCELANOSA GRUPO.

Standard shower trays for linear grating

These shower trays feature a 40 mm thickness. It includes the imperband standard kit. Does not include linear gratings.

concept xps shower trays



Square shower trays with lateral linear grating: LAT Q

SAP		Presentation	P/EU
100106439	1200 x 1200 x 40 mm	Shower tray + Kit imperband	887.57 p/u
100114485	1500 x 1500 x 40 mm	Shower tray + Kit imperband	1038.42 p/u

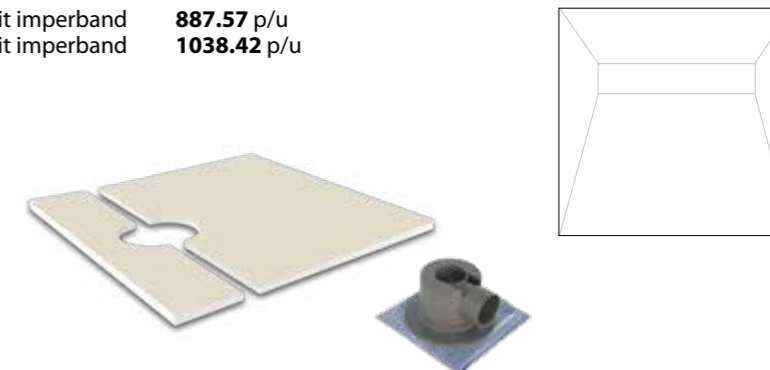

Rectangular shower trays with lateral linear grating: LAT R

SAP		Presentation	P/EU
100105150	900 x 1200 x 40 mm	Shower tray + Kit imperband	677.71 p/u
100106441	900 x 1500 x 40 mm	Shower tray + Kit imperband	737.82 p/u
100114491	900 x 1600 x 40 mm	Shower tray + Kit imperband	754.23 p/u
100108880	900 x 1800 x 40 mm	Shower tray + Kit imperband	776.09 p/u
100106438	1000 x 1200 x 40 mm	Shower tray + Kit imperband	683.18 p/u

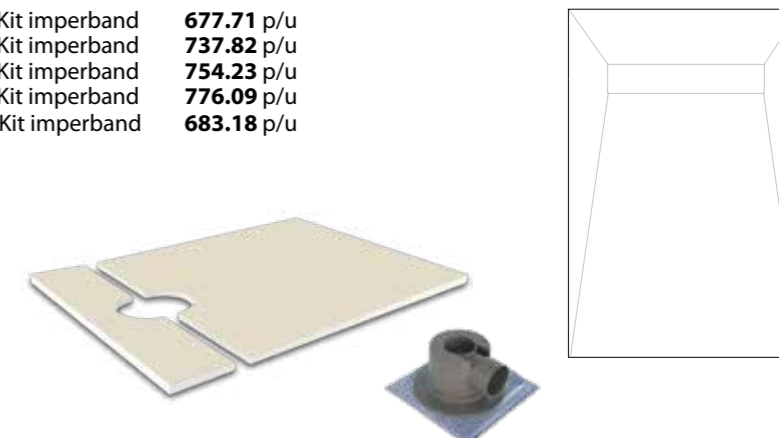

Linear gratings

Information referring to linear gratings is on page 188 - 191.

Select the linear grid depending on the shower tray width, so that the minimum distance between the grid and the concept xps shower tray sides exceeds 100 mm on both sides. We recommend to follow the instructions given in the table below:

Grid length:	Shower tray width:
59.6 x 9.3 cm	> 800 mm
80 x 9.3 cm	> 1000 mm
120 x 9.3 cm	> 1400 mm

The shower tray width corresponds to the second digit of the columns corresponding to Rectangular Shower Tray and Square Shower Tray

All the concept xps shower trays have available a 50 mm thickness special piece to increase the height of the shower tray and cover sewer and drain. Check conditions with your sales representative from PORCELANOSA GRUPO.

Refurbishing shower trays for square grating

These shower trays feature a 30 mm thickness. It includes the imperband refurbishing kit. Does not include the square grating.

concept xps shower trays



Square shower trays with square corner grating: ESQ

SAP		Presentation	P/EU
100103297	900 x 900 x 30 mm	Shower tray + Kit imperband	331.01 p/u
100103282	1000 x 1000 x 30 mm	Shower tray + Kit imperband	338.88 p/u
100103295	1200 x 1200 x 30 mm	Shower tray + Kit imperband	365.91 p/u

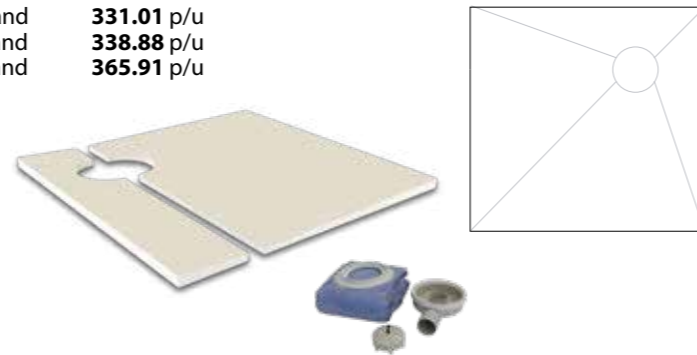

Rectangular shower trays with lateral square grid: LAT

SAP		Presentation	P/EU
100103300	900 x 1200 x 30 mm	Shower tray + Kit imperband	340.58 p/u
100103314	900 x 1500 x 30 mm	Shower tray + Kit imperband	371.54 p/u
100103293	1000 x 1200 x 30 mm	Shower tray + Kit imperband	341.14 p/u

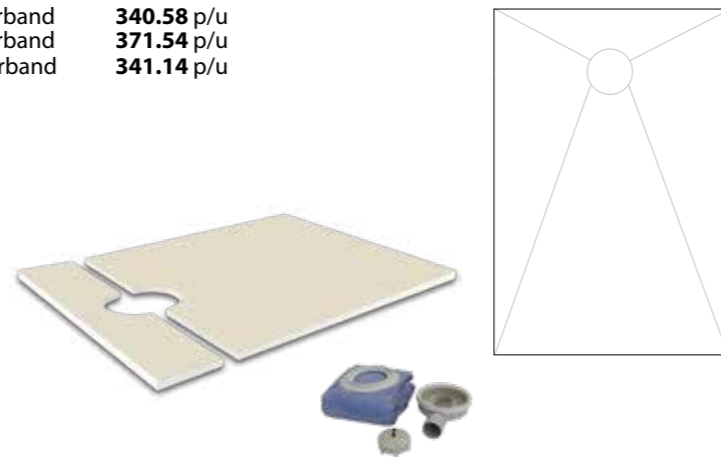

Square gratings

Information referring to squared gratings is on page 192 - 193.

SAP	Square grating
100148572	standard n squared
100114593	sun
100293010	square chrome
100293012	square tile

All the concept xps shower trays have available a 50 mm thickness special piece to increase the height of the shower tray and cover sewer and drain. Check conditions with your sales representative from PORCELANOSA GRUPO.

Refurbishing shower trays for linear grating

These shower trays feature a 30 mm thickness. It includes the imperband refurbishing kit. Does not include linear gratings.

concept xps shower trays



Square shower trays with lateral linear grating: LAT Q

SAP		Presentation	P/EU
100114466	1000 x 1000 x 30 mm	Shower tray + Kit imperband	677.71 p/u
100114476	1200 x 1200 x 30 mm	Shower tray + Kit imperband	887.57 p/u

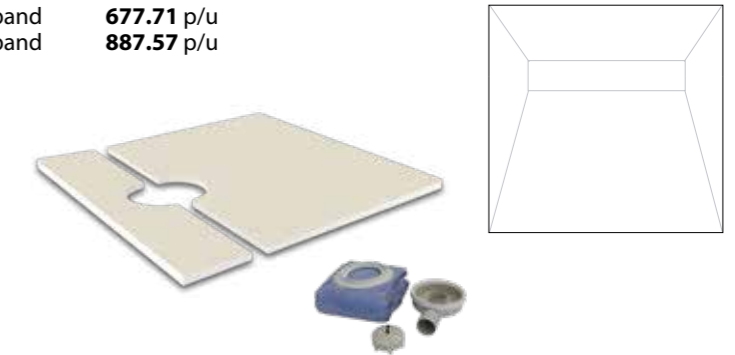

Rectangular shower trays with lateral linear grating: LAT R

SAP		Presentation	P/EU
100114471	900 x 1000 x 30 mm	Shower tray + Kit imperband	666.77 p/u
100111299	900 x 1200 x 30 mm	Shower tray + Kit imperband	677.71 p/u
100114473	1000 x 1200 x 30 mm	Shower tray + Kit imperband	683.18 p/u
100114481	1400 x 900 x 30 mm	Shower tray + Kit imperband	699.57 p/u
100114487	900 x 1500 x 30 mm	Shower tray + Kit imperband	737.82 p/u
100114464	900 x 1600 x 30 mm	Shower tray + Kit imperband	754.23 p/u
100110584	900 x 1800 x 30 mm	Shower tray + Kit imperband	776.09 p/u

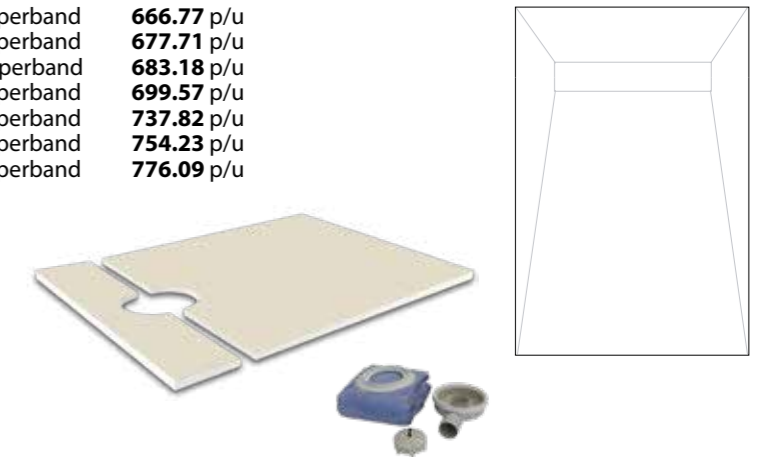

Linear gratings

Information referring to linear gratings is on page 188 - 191.

Select the linear grid depending on the shower tray width, so that the minimum distance between the grid and the concept xps shower tray sides exceeds 100 mm on both sides. We recommend to follow the instructions given in the table below:

Grid length:	Shower tray width:
59.6 x 9.3 cm	> 800 mm
80 x 9.3 cm	> 1000 mm
120 x 9.3 cm	> 1400 mm

The shower tray width corresponds to the second digit of the columns corresponding to Rectangular Shower Tray and Square Shower Tray

All the concept xps shower trays have available a 50 mm thickness special piece to increase the height of the shower tray and cover sewer and drain. Check conditions with your sales representative from PORCELANOSA GRUPO.



Bespoke shower trays

If you need a shower tray with certain dimensions or shape that cannot be found in our standard shower trays range, butech can make the shower tray with the shape and dimensions you need.

Just send us a drawing with the dimensions and shape you want for your shower tray and we will give you a price and a delivery date. If you agree, we will make your custom shower tray.

For making a square or rectangular shower tray, we need the following information:

- Shower tray dimensions
 - Long side xP
 - Wide side yP
 - Thickness choose among 30/40 mm
- Grating type
 - Square grating
 - Linear grating choose among 59.6/80/120 mm
- Drain position
 - Long side xS
 - Wide side yS

All dimensions must be entered in millimeters.

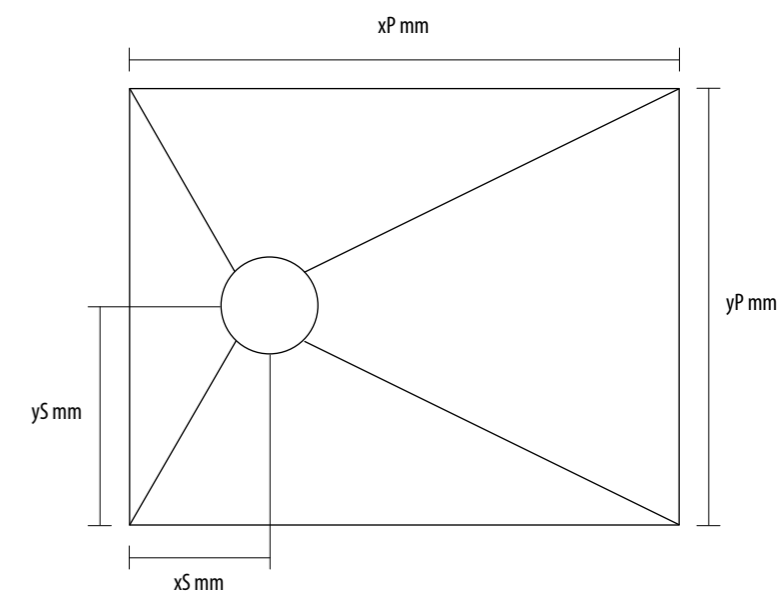

All custom drains include the imperband kit corresponding to the thickness of the chosen board.

Decorative grating is not included. Refer to page 188 - 193.

All the custom concept xps shower trays have available a 50 mm thickness special piece to increase the height of the shower tray and cover sewer and drain. Check conditions with your sales representative from PORCELANOSA GRUPO.

In case you need a shower tray with a non orthogonal shape, check with butech sales department.

Bespoke standard shower trays

These shower trays feature a 40 mm thickness. It includes the imperband standard kit. Does not include square gratings.

concept xps shower trays



Square shower trays with square corner grating: ESQ Q

SAP		Presentation	P/EU
100103244	1-1000 x < 1000 x 40 mm	Shower tray + Kit imperband	377.17 p/u
100103240	1001-1200 x < 1200 x 40 mm	Shower tray + Kit imperband	450.91 p/u
100103254	1201-1400 x < 1400 x 40 mm	Shower tray + Kit imperband	524.66 p/u
100103260	1401-1600 x < 1600 x 40 mm	Shower tray + Kit imperband	598.95 p/u

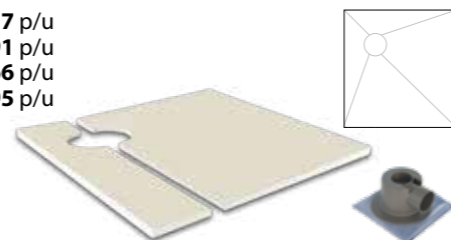

Square shower trays with central square grating: CENT Q

SAP		Presentation	P/EU
100103242	1-1000 x < 1000 x 40 mm	Shower tray + Kit imperband	377.17 p/u
100103238	1001-1200 x < 1200 x 40 mm	Shower tray + Kit imperband	451.47 p/u
100103252	1201-1400 x < 1400 x 40 mm	Shower tray + Kit imperband	524.66 p/u
100103258	1401-1600 x < 1600 x 40 mm	Shower tray + Kit imperband	598.95 p/u

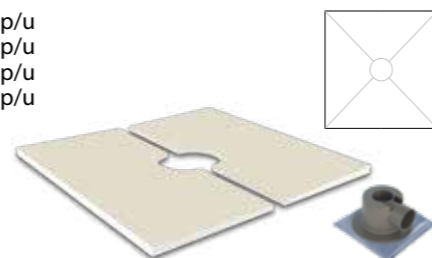

Rectangular shower trays with square lateral grating: LAT R

SAP		Presentation	P/EU
100103245	1-1000 x < 901 x 40 mm	Shower tray + Kit imperband	370.16 p/u
100103241	1001-1200 x < 901 x 40 mm	Shower tray + Kit imperband	371.81 p/u
100103255	1201-1400 x < 901 x 40 mm	Shower tray + Kit imperband	515.15 p/u
100103261	1401-1600 x < 901 x 40 mm	Shower tray + Kit imperband	602.33 p/u
100103268	1601-1800 x < 901 x 40 mm	Shower tray + Kit imperband	677.21 p/u

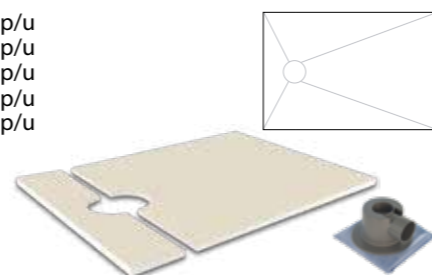

The maximum length of the wide side of this type of tray is 900 mm. For higher lengths, check with butech sales department.

Rectangular shower trays with central square grating: CENT R

SAP		Presentation	P/EU
100103243	1-1000 x < 901 x 40 mm	Shower tray + Kit imperband	379.41 p/u
100103239	1001-1200 x < 901 x 40 mm	Shower tray + Kit imperband	381.66 p/u
100103253	1201-1400 x < 901 x 40 mm	Shower tray + Kit imperband	525.78 p/u
100103259	1401-1600 x < 901 x 40 mm	Shower tray + Kit imperband	602.33 p/u
100103269	1601-1800 x < 901 x 40 mm	Shower tray + Kit imperband	677.77 p/u
100103271	1801-2000 x < 901 x 40 mm	Shower tray + Kit imperband	733.74 p/u
100103273	2001-2200 x < 901 x 50 mm	Shower tray + Kit imperband	827.51 p/u

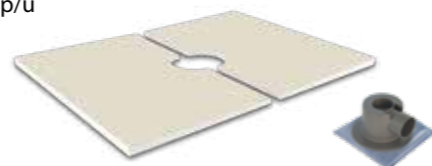

The maximum length of the wide side of this type of tray is 900 mm. For higher lengths, check with butech sales department.

All the concept xps shower trays have available a 50 mm thickness special piece to increase the height of the shower tray and cover sewer and drain. Check conditions with your sales representative from PORCELANOSA GRUPO.

Information referring to squared gratings is on page 192 - 193.

Bespoke standard shower trays for linear grating

These shower trays feature a 40 mm thickness. It includes the imperband standard kit. Does not include linear gratings.

concept xps shower trays



Square shower trays with lateral linear grating: LINEAL LAT Q

SAP		Presentation	P/EU
100116102	1-1000 x < 1000 x 40 mm	Shower tray + Kit imperband	677.71 p/u
100116110	1001-1200 x < 1200 x 40 mm	Shower tray + Kit imperband	699.57 p/u
100116118	1201-1400 x < 1400 x 40 mm	Shower tray + Kit imperband	721.43 p/u
100116126	1401-1600 x < 1600 x 40 mm	Shower tray + Kit imperband	737.82 p/u

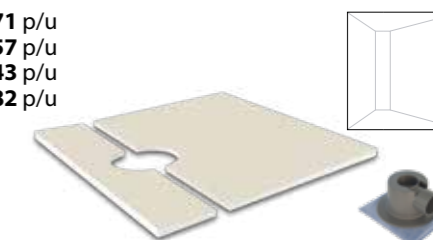

Square shower trays with central linear grating: LINEAL CENT Q

SAP		Presentation	P/EU
100116100	1-1000 x < 1000 x 40 mm	Shower tray + Kit imperband	677.71 p/u
100116108	1001-1200 x < 1200 x 40 mm	Shower tray + Kit imperband	699.57 p/u
100116116	1201-1400 x < 1400 x 40 mm	Shower tray + Kit imperband	721.43 p/u
100116124	1401-1600 x < 1600 x 40 mm	Shower tray + Kit imperband	737.82 p/u

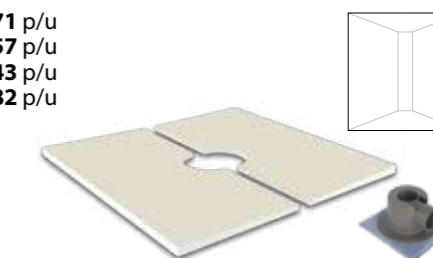

Rectangular shower trays with linear side grating: LINEAL LAT R

SAP		Presentation	P/EU
100116103	1-1000 x < 901 x 40 mm	Shower tray + Kit imperband	677.71 p/u
100116111	1001-1200 x < 901 x 40 mm	Shower tray + Kit imperband	699.57 p/u
100116119	1201-1400 x < 901 x 40 mm	Shower tray + Kit imperband	721.43 p/u
100110295	1401-1600 x < 901 x 40 mm	Shower tray + Kit imperband	737.82 p/u
100110164	1601-1800 x < 901 x 40 mm	Shower tray + Kit imperband	743.28 p/u
100116136	1801-2000 x < 901 x 40 mm	Shower tray + Kit imperband	819.80 p/u
100116140	2001-2200 x < 901 x 50 mm	Shower tray + Kit imperband	874.46 p/u

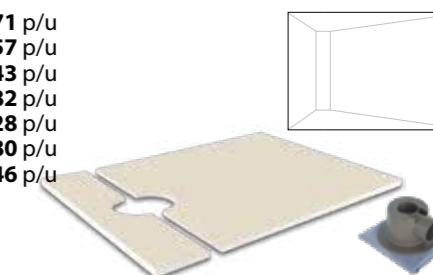

The maximum length of the wide side of this type of tray is 900 mm. For higher lengths, check with butech sales department.

Rectangular shower trays with central linear grating: LINEAL CENT R

SAP		Presentation	P/EU
100116101	1-1000 x < 901 x 40 mm	Shower tray + Kit imperband	677.71 p/u
100116109	1001-1200 x < 901 x 40 mm	Shower tray + Kit imperband	699.57 p/u
100116117	1201-1400 x < 901 x 40 mm	Shower tray + Kit imperband	721.43 p/u
100116125	1401-1600 x < 901 x 40 mm	Shower tray + Kit imperband	737.82 p/u
100116131	1601-1800 x < 901 x 40 mm	Shower tray + Kit imperband	743.28 p/u
100116135	1801-2000 x < 901 x 40 mm	Shower tray + Kit imperband	819.80 p/u
100116139	2001-2200 x < 901 x 50 mm	Shower tray + Kit imperband	874.46 p/u



The maximum length of the wide side of this type of tray is 900 mm. For higher lengths, check with butech sales department.

All the concept xps shower trays have available a 50 mm thickness special piece to increase the height of the shower tray and cover sewer and drain. Check conditions with your sales representative from PORCELANOSA GRUPO.

Information referring to linear gratings is on page 188 - 191.

Bespoke refurbishing shower trays

These shower trays feature a 30 mm thickness. It includes the imperband refurbishing kit. Does not include squaregratings.

concept xps shower trays



Square shower trays with square corner grating: ESQ Q

SAP		Presentation	P/EU
100103290	1-1000 x < 1000 x 30 mm	Shower tray + Kit imperband	398.55 p/u
100103286	1001-1200 x < 1200 x 30 mm	Shower tray + Kit imperband	471.74 p/u
100103303	1201-1400 x < 1400 x 30 mm	Shower tray + Kit imperband	546.05 p/u
100103309	1401-1600 x < 1600 x 30 mm	Shower tray + Kit imperband	619.23 p/u

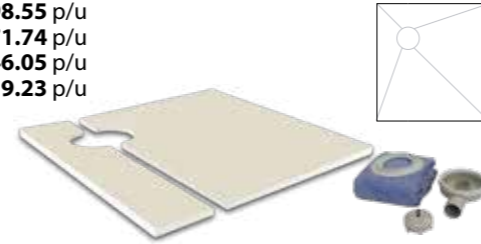

Square shower trays with central square grating: CENT Q

SAP		Presentation	P/EU
100103288	1-1000 x < 1000 x 30 mm	Shower tray + Kit imperband	398.55 p/u
100103284	1001-1200 x < 1200 x 30 mm	Shower tray + Kit imperband	471.74 p/u
100103301	1201-1400 x < 1400 x 30 mm	Shower tray + Kit imperband	545.49 p/u
100103307	1401-1600 x < 1600 x 30 mm	Shower tray + Kit imperband	619.23 p/u

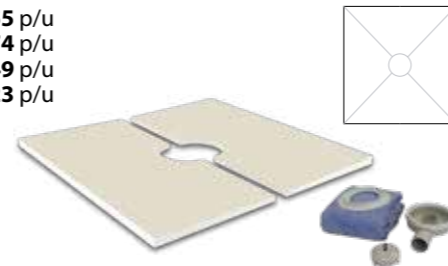

Rectangular shower trays with square lateral grating: LAT R

SAP		Presentation	P/EU
100103291	1-1000 x < 901 x 30 mm	Shower tray + Kit imperband	400.25 p/u
100103287	1001-1200 x < 901 x 30 mm	Shower tray + Kit imperband	401.93 p/u
100103304	1201-1400 x < 901 x 30 mm	Shower tray + Kit imperband	534.92 p/u
100103310	1401-1600 x < 901 x 30 mm	Shower tray + Kit imperband	623.72 p/u
100103317	1601-1800 x < 901 x 30 mm	Shower tray + Kit imperband	698.03 p/u

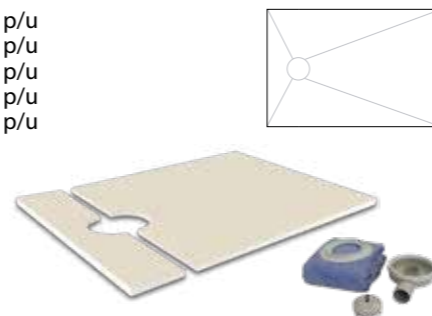

The maximum length of the wide side of this type of tray is 900 mm. For higher lengths, check with butech sales department.

Rectangular shower trays with central square grating: CENT R

SAP		Presentation	P/EU
100103289	1-1000 x < 901 x 30 mm	Shower tray + Kit imperband	400.80 p/u
100103285	1001-1200 x < 901 x 30 mm	Shower tray + Kit imperband	401.93 p/u
100103302	1201-1400 x < 901 x 30 mm	Shower tray + Kit imperband	546.05 p/u
100103308	1401-1600 x < 901 x 30 mm	Shower tray + Kit imperband	624.85 p/u
100103318	1601-1800 x < 901 x 30 mm	Shower tray + Kit imperband	698.03 p/u
100103320	1801-2000 x < 901 x 30 mm	Shower tray + Kit imperband	774.59 p/u
100103322	2001-2200 x < 901 x 50 mm	Shower tray + Kit imperband	850.03 p/u

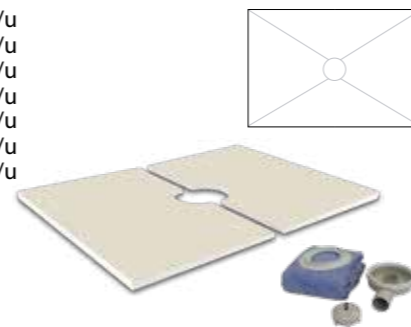

The maximum length of the wide side of this type of tray is 900 mm. For higher lengths, check with butech sales department.

All the concept xps shower trays have available a 50 mm thickness special piece to increase the height of the shower tray and cover sewer and drain. Check conditions with your sales representative from PORCELANOSA GRUPO.

Information referring to squared gratings is on page 192 - 193.

Bespoke refurbishing shower trays for linear grating

These shower trays feature a 30 mm thickness. It includes the imperband refurbishing kit. Does not include linear gratings.

concept xps shower trays



Square shower trays with lateral linear grating: LINEAL LAT Q

SAP		Presentation	P/EU
100116098	1-1000 x < 1000 x 30 mm	Shower tray + Kit imperband	677.71 p/u
100116106	1001-1200 x < 1200 x 30 mm	Shower tray + Kit imperband	699.57 p/u
100116114	1201-1400 x < 1400 x 30 mm	Shower tray + Kit imperband	721.43 p/u
100116122	1401-1600 x < 1600 x 30 mm	Shower tray + Kit imperband	737.82 p/u

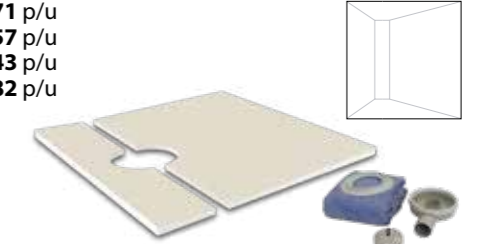

Square shower trays with central linear grating: LINEAL CENT Q

SAP		Presentation	P/EU
100116096	1-1000 x < 1000 x 30 mm	Shower tray + Kit imperband	677.71 p/u
100116104	1001-1200 x < 1200 x 30 mm	Shower tray + Kit imperband	699.57 p/u
100116112	1201-1400 x < 1400 x 30 mm	Shower tray + Kit imperband	721.43 p/u
100116120	1401-1600 x < 1600 x 30 mm	Shower tray + Kit imperband	737.82 p/u

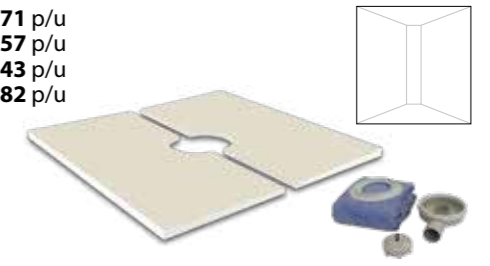

Rectangular shower trays with linear side grating: LINEAL LAT R

SAP		Presentation	P/EU
100116099	1-1000 x < 901 x 30 mm	Shower tray + Kit imperband	677.71 p/u
100116107	1001-1200 x < 901 x 30 mm	Shower tray + Kit imperband	699.57 p/u
100116115	1201-1400 x < 901 x 30 mm	Shower tray + Kit imperband	721.43 p/u
100116123	1401-1600 x < 901 x 30 mm	Shower tray + Kit imperband	737.82 p/u
100116130	1601-1800 x < 901 x 30 mm	Shower tray + Kit imperband	743.28 p/u
100116134	1801-2000 x < 901 x 30 mm	Shower tray + Kit imperband	819.80 p/u
100116138	2001-2200 x < 901 x 50 mm	Shower tray + Kit imperband	874.46 p/u

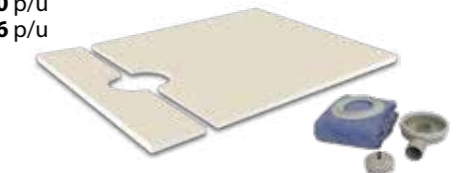

The maximum length of the wide side of this type of tray is 900 mm. For higher lengths, check with butech sales department.

Rectangular shower trays with central linear grating: LINEAL CENT R

SAP		Presentation	P/EU
100116097	1-1000 x < 901 x 30 mm	Shower tray + Kit imperband	677.71 p/u
100116105	1001-1200 x < 901 x 30 mm	Shower tray + Kit imperband	699.57 p/u
100116113	1201-1400 x < 901 x 30 mm	Shower tray + Kit imperband	721.43 p/u
100116121	1401-1600 x < 901 x 30 mm	Shower tray + Kit imperband	737.82 p/u
100116129	1601-1800 x < 901 x 30 mm	Shower tray + Kit imperband	743.28 p/u
100116133	1801-2000 x < 901 x 30 mm	Shower tray + Kit imperband	819.80 p/u
100116137	2001-2200 x < 901 x 50 mm	Shower tray + Kit imperband	874.46 p/u

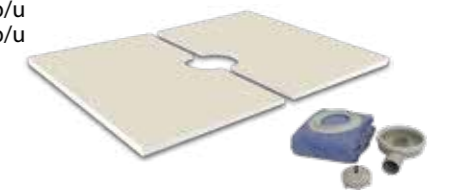

The maximum length of the wide side of this type of tray is 900 mm. For higher lengths, check with butech sales department.

All the concept xps shower trays have available a 50 mm thickness special piece to increase the height of the shower tray and cover sewer and drain. Check conditions with your sales representative from PORCELANOSA GRUPO.

Information referring to linear gratings is on page 188 - 191.

Panel concept xps

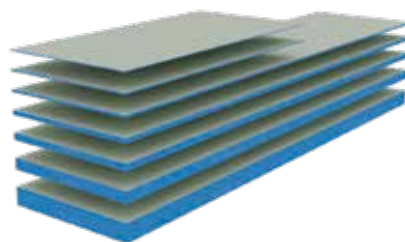
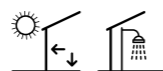

concept xps panels are extruded polystyrene panels ready for laying wall tiles, mosaics or natural stone with cement-based adhesives. Polystyrene lightness and easy handling, as well as its mechanical resistance and damp resistance make of this panel the perfect substrate for all kinds of environments where damp is present.

This kind of panel is available in thicknesses ranging from 4 to 80 mm and also in special precut boards that allow for a fast installation of curved shapes.

Features:

- Extruded polystyrene boards covered on both sides with waterproof cement mortar.
- Non-absorbent material. Its structure prevents water buildup. Resistant to dampness.
- Excellent surface for laying rectified tiles.
- Low thermal conductivity coefficient.
- Good soundproofing against impact noise.
- Easy handling and transport.
- Quick and clean installation.
- Resistant to microorganism attack.
- Inert and non-hazardous material made with 50% to 70% recycled material.
- Fire resistant: B1 as per DIN 4102.

Substrates:

- Usual indoor substrates in the building industry.
- Uncovered brick partition walls.
- Concrete floor slabs.
- Existing wall and floor tiles.
- Self-supporting indoors. Only 50 and 80 mm boards.

Recommended uses:

- Preparation of substrates for ceramic tiles laying. Specially recommended in refurbishing jobs.
- Bathroom countertops and vanities in permanently wet areas.
- Bathroom partition walls and platforms.
- Bathtub skirts and shower cabins.
- Shelves and panels attached to partition walls.
- Health resorts, saunas and spa premises.
- Thermal insulation of electric radiant heating floors.

Materials:

- Absorbent and non-absorbent ceramic tiles. Porcelain tiles with a water absorption < 0.5% as per EN-ISO 10545-3.
- Glass mosaic.
- Natural stone and marble not prone to staining.

Fixing elements for concept xps panels

concept fastening

SAP		Presentation	P/EU
100067686	45 mm metal fastening	50 ud/bag	35.09 p/bag
100062773	130 mm plastic fastening	10 ud/bag	10.28 p/bag
100062774	130 mm plastic fastening	50 ud/bag	47.71 p/bag
100062775	80 mm plastic fastening	10 ud/bag	7.58 p/bag
100062776	80 mm plastic fastening	50 ud/bag	32.42 p/bag



Self-adhesive fiberglass mesh roll

SAP		Presentation	P/EU
100062825	self-adhesive fiberglass mesh	Roll 10 m	10.44 p/roll
100062826	self-adhesive fiberglass mesh	Roll 20 m	18.00 p/roll



Polyurethane putty

SAP		Presentation	P/EU
100292915	h-920	290 ml	10.18 p/u
100031189	super-one gris	25kg	1.17 p/kg



Technical features

PROPERTIES	STANDARD	VALUE
Compression resistance (10% strain)	DIN 53421	300 KN/m ²
Nominal density	EN 1602	35 Kg/m ³
Shear resistance	EN 12090	0,25 N/mm ²
Tensile strength	EN 1607	0,50 N/mm ²
Adherence of the protection		> 2,0 Kg/cm ²
Resistance to eccentric load		> 10,0 Kg/cm ²
Water absorption		< 1,0 Kg/m ²
Thermal conductivity	EN 13164	0,034 W/m.k (30-60 mm) 0,036 W/m.k (> 60 mm)
Working temperature range		-50 °C / +75 °C
Tolerances		Length: +/- 5 mm Width: +/- 3 mm Thickness: +/- 2 mm Squareness: < 2 mm/m.l.
Fire resistance	DIN 4102-1	B s1-d0

concept xps panels

SAP		ud./pallet	P/EU
100103351	4 mm 1250 x 600	300	23.01 p/u
100103352	6 mm 1250 x 600	280	22.17 p/u
100103349	10 mm 2500 x 600	225	48.24 p/u
100103350	20 mm 2500 x 600	111	52.01 p/u
100103354	30 mm 2500 x 600	80	58.69 p/u
100103355	50 mm 2500 x 600	45	67.85 p/u
100103356	80 mm 2500 x 600	31	106.10 p/u

WATERPROOFING

imperband deck kit



Waterproofing system for ceramic parquet-covered shower trays; specially designed for PORCELANOSA Grupo's PAR-KER lines. In this system, the traditional metal grid is replaced with a ceramic piece so that the drain system is hidden from sight. Professional use.

PAR-KER is compatible with shower trays that have one, two, or four slopes, draining only through an open joint in the shower tray covering. A new invisible drain concept, for the best bathroom designs.

Characteristics:

- Drainage system for ceramic-covered and ceramic trim shower trays.
- Drainage through the open perimeter joint around the ceramic cover. Drainage joint width: 4 mm.
- Ultra-slim shower tray; only 22 mm in height, plus 60 mm from the drain.
- Compatible with all butech shower waterproofing systems: imperband, sylastic, and imperbo x
- Suitable for all PAR-KER models of less than 150 cm in length
- High resistance to domestic-use detergents.
- Safe and easy to maintain system.
- Quick and easy installation.

Materials:

- Anti-slip porcelain tile plates.
- STON-KER antislip
- PAR-KER antislip
- URBATEK antislip

Substrates:

- Cement covered floors

Componentes:

- Tray with the corresponding measure with 15 cm thermo-sealed imperband flange
- Horizontal drain and trap. Output Ø 40mm and 0.52l/s
- Manhole key
- 5 meter imperband roll

* Ceramic trim not included

Recommended use:

Ceramic showers with ceramic parquet covering. Especially recommended for the following models:

- PAR-KER 219 x 660 mm
- PAR-KER 210 x 659 mm
- PAR-KER 143 x 900 mm
- PAR-KER 220 x 900 mm
- PAR-KER 193 x 1200 mm
- PAR-KER 294 x 1200 mm

Installation:

- Connect the deck drain to the drain pipe.
- Connect the deck drain to the base kit imperband deck.
- Prepare the shower tray base with cement mortar and level with the base kit imperband deck, and let dry. As a general rule, we recommend a 2% slope
- Once the shower tray base is dry, waterproof the joint between the base kit imperband deck and the shower tray by using the imperband perimeter band. Bond with a C2 S1 adhesive as per EN 12004, such as one-flex premium.
- Waterproof both the shower tray and the shower walls with the chosen system. Although butech offers several systems that are compatible with the imperband deck kit, we recommend the imperband waterproof sheet; follow the instructions for use strictly.
- Install the shower tray floor using the thin layer, double bonding technique. Use an adhesive that is at least a C2 S1 as per EN 12004, suitable for the chosen ceramic type.
- Install the ceramic trim.
- Fill the tile joints of the shower tray covering with a moisture-resistant material; as a general rule, we recommend RG materials as per EN 13888, such as epotech nature.
- Seal the shower tray perimeter joints and wall intersections using an elastic sealant such as s-107 n

deck imperband kit

SAP		Presentation	P/EU
100215018	Kit 210 x 659 mm	1ud/box	339.88 p/u
100215040	Kit 219 x 660 mm	1ud/box	346.73 p/u
100214989	Kit 143 x 900 mm	1ud/box	338.36 p/u
100215031	Kit 220 x 900 mm	1ud/box	414.78 p/u
100214995	Kit 193 x 1200 mm	1ud/box	463.44 p/u
100215006	Kit 294 x 1200 mm	1ud/box	595.36 p/u
100215023	Kit 250 x 1500 mm	1ud/box	631.48 p/u
100231470	Beskope		

Before using this product in any application not indicated in this catalogue, please perform a test or refer to the product's technical sheet.



SHOWER TRAYS AND WATERPROOFING

imperband standard kit



The **standard imperband kit** is an indoor waterproofing system consisting of a PVC gutter thermowelded to a 150 x 225 cm waterproof sheet. Specially recommended for waterproofing shower trays in new building works. Residential use.

The waterproof sheet is an imperband type 0,5 mm thick polymer membrane with a double thermoplastic polyolefin sheet and covered on both sides by non woven polyester fibers that allow it to be bonded to surfaces using cement-based adhesives. The gutter features a compact design and multiple possibilities of outlet connections.

It does not include neither the grate nor the drain frame.



Features:

- Maximum security, it eliminates leakage risks between waterproof sheet and drain piece.
- 150 x 225 cm waterproof sheet.
- Discharge speed. 0.6 l/s.
- Compact system, just 100 mm high.
- Adaptable to horizontal and vertical outlets. Asjustable outlet diameter: 40/50 mm.
- Includes u-bend.
- Direct installation of the tile on the waterproof sheet.
- Quick and easy application.

Recommended use:

- Specially designed for waterproofing built in showers.

Materials:

- Absorbent and non-absorbent ceramic tiles. Porcelain tiles with a water absorption < 0.5% as per EN-ISO 10545-3.
- Glass mosaic.
- Natural stone.

Substrates:

- Cement covered floors.
- Specially designed for Concept XPS shower trays, prefabricated polystyrene panels.

imperband kit

SAP	Presentation	P/EU
100103360	Kit 150 x 225 cm 1ud/box	95.53 p/u

Before using this product in any application not indicated in this catalogue, please perform a test or refer to the product's technical sheet.

imperband refurbishing kit n



The **imperband refurbishing kit n** is an indoor waterproofing system consisting of an extrathin PVC gutter thermowelded to a 150 x 225 cm waterproof sheet. Specially recommended for waterproofing shower trays in refurbishing jobs. Residential use.

The waterproof sheet is an imperband type 0.5 mm thick polymer membrane with a double thermoplastic polyolefin sheet and covered on both sides by non woven polyester fibers that allow it to be bonded to surfaces using cement-based adhesives. The only 65 mm drain height allows to carry out installations of 75 mm from the substrate to the ceramic wall covering.

It does not include neither the grate nor the drain frame.



Features:

- Maximum security, it eliminates leakage risks between waterproof sheet and drain piece.
- 150 x 225 cm waterproof sheet.
- Discharge speed. 0.5 l/s.
- Very compact system, just 75 mm high.
- 50 mm diameter horizontal outlet.
- Includes u-bend.
- Direct installation of the tile on the waterproof sheet.
- Quick and easy application.

Recommended use:

- Specially designed for waterproofing showers in refurbishing jobs.

Materials:

- Absorbent and non-absorbent ceramic tiles. Porcelain tiles with a water absorption < 0.5% as per EN-ISO 10545-3.
- Glass mosaic.
- Natural stone.

Substrates:

- Cement covered floors.
- Specially designed for Concept XPS shower trays, prefabricated polystyrene panels.

kit imperband

SAP	Presentation	P/EU
100187047	Kit 150 x 225 cm 1ud/box	119.92 p/u

Before using this product in any application not indicated in this catalogue, please perform a test or refer to the product's technical sheet.

linear grates



glass white			
SAP		Presentation	P/EU
100141156	93 x 596 mm	1ud/box	359.23 p/u



ceramic framed			
SAP		Presentation	P/EU
100148593	93 x 596 mm	1ud/box	299.60 p/u
100148595	93 x 800 mm	1ud/box	398.97 p/u
100148594	93 x 1200 mm	1ud/box	541.07 p/u



glass black			
SAP		Presentation	P/EU
100141153	93 x 596 mm	1ud/box	359.23 p/u



black			
SAP		Presentation	P/EU
100278946	93 x 596 mm	1ud/box	503.71 p/u



Includes drainage channel and grate.

Includes drainage channel and grate.

Before using this product in any application not indicated in this catalogue, please perform a test or refer to the product's technical sheet.

Before using this product in any application not indicated in this catalogue, please perform a test or refer to the product's technical sheet.

linear grates



chrome texture			
SAP		Presentation	P/EU
100103365	93 x 596 mm	1ud/box	295.88 p/u
100103366	93 x 800 mm	1ud/box	388.06 p/u
100103364	93 x 1200 mm	1ud/box	554.26 p/u



squared			
SAP		Presentation	P/EU
100103371	93 x 596 mm	1ud/box	266.59 p/u
100103372	93 x 800 mm	1ud/box	354.18 p/u
100103370	93 x 1200 mm	1ud/box	484.00 p/u



texture			
SAP		Presentation	P/EU
100103368	93 x 596 mm	1ud/box	281.97 p/u
100103369	93 x 800 mm	1ud/box	384.45 p/u
100103367	93 x 1200 mm	1ud/box	532.12 p/u



line			
SAP		Presentation	P/EU
100103374	93 x 596 mm	1ud/box	261.56 p/u
100103375	93 x 800 mm	1ud/box	354.18 p/u
100103373	93 x 1200 mm	1ud/box	484.00 p/u



Includes drainage channel and grate.

Includes drainage channel and grate.

Before using this product in any application not indicated in this catalogue, please perform a test or refer to the product's technical sheet.

Before using this product in any application not indicated in this catalogue, please perform a test or refer to the product's technical sheet.

square grates



standard n squared

SAP		Presentation	P/EU
100148572	standard n squared	1ud/box	38.62 p/u



sun

SAP		Presentation	P/EU
100114593	sun	1ud/box	49.98 p/u



square chrome

SAP		Presentation	P/EU
100293010	square chrome	1ud/box	45.35 p/u



All references include drain channel and grate.

Before using this product in any application not indicated in this catalogue, please perform a test or refer to the product's technical sheet.

square tile

SAP		Presentation	P/EU
100293012	square tile	1ud/box	140.25 p/u



Includes drainage channel and grate. Tile not included in the grate.



Before using this product in any application not indicated in this catalogue, please perform a test or refer to the product's technical sheet.

imperbox

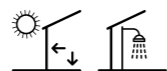

imperbox is paste, ready-to-use waterproofing system specially recommended for waterproofing plasterboard indoors. Compatible with type C2 cement-based adhesive as per EN 12004. Indoor use.

Paste with water-dispersed acrylic polymers that provide it with excellent bonding and deformability properties, which means it can be used over the most common types of substrates used in construction. Special pieces and bands available for waterproofing joints and other critical spots.



Features:

- Water-based paste.
- Indoor waterproofer.
- Excellent adherence. Flexible.
- Good chemical resistance.
- Quick and easy application.

Materials:

- Absorbent and non-absorbent ceramic tiles. Porcelain tiles with a water absorption < 0.5% as per EN-ISO 10545-3.
- Glass mosaic.
- Natural stone and marble.

Substrates:

- Cement covered floors and walls .
- Anhydrite or plaster covered floors and walls .
- Concrete slabs.
- Plasterboards.
- Plywood boards.

Coverage:

Bond coat	
• One-layer application	1.8 kg / m ²
Waterproofing	
• Two-layer application	3.6 kg / m ²
Mean thickness per imperbox layer: 1.5 mm	

Recommended use:

- Private bathrooms. Built in showers.
- Public toilets and showers.
- Spas and premises in permanently damp environments.
- Balconies, covered terraces, cornices and gutters.
- Adhesion promoter on old vinyl and polyurethane adhesives.
- Do not use in outdoors surfaces greater than 10 m².

Angles and waterproof bands:

Special pieces made of waterproof thermoplastic rubber, mounted on polyester sheets which allow laying with type C2 cement-based adhesives as per EN 12004. Specially designed for waterproofing critical spots.

- 1. Inner angle:** Piece for sealing inner corners.
- 2. Outer angle:** Piece for sealing outer corners.
- 3. Waterproof band:** 8 cm wide waterproofing band for sealing edges, level changes and movement joints.



imperbox			
SAP		Presentation	P/EU
100006223	imperbox manhattan	10 Kg can 450 Kg/pallet	6.97 p/kg
100006210	outer angle	unit	8.16 p/u
100006211	inner angle	unit	8.16 p/u
100081532	5 ml waterproof band	Roll 5 m	4.44 p/m
100081531	10 ml waterproof band	Roll 10 m	4.23 p/m
100006221	50 ml waterproof band	Roll 50 m	4.08 p/m

Before using this product in any application not indicated in this catalogue, please perform a test or refer to the product's technical sheet.

sylastic

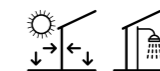

sylastic is a two-component cement-based waterproofer with excellent bonding and deformability features, specially recommended for waterproofing outdoors. Compatible with type C2 cement-based adhesive as per EN 12004. Indoor and outdoor use.

Prevents the need of screed between waterproofing sheet and ceramic floor, thus reducing the final system thickness. It is applied in two 1-2 mm layers each, with a fiberglass mesh reinforcement on the first application. Special pieces and bands available for waterproofing joints and other critical spots.

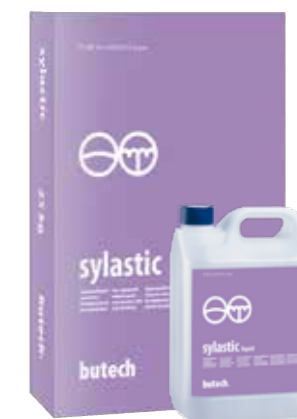

Features:

- Two-component waterproofing mortar.
- Indoor and outdoor waterproofer.
- Maximum waterproofing with minimal thickness (3 mm).
- It allows for direct laying of ceramic tiles with cement-based adhesive.
- Excellent adherence and maximum deformability.
- Good chemical resistance.
- Suitable for direct contact with water.

Substrates:

- Cement covered floors and walls .
- Concrete slabs.
- Plasterboards.
- Wood boards.
- Existing floor tiles.
- Metal sheets.

Materials:

- Absorbent and non-absorbent ceramic tiles. Porcelain tiles with a water absorption < 0.5% as per EN-ISO 10545-3.
- Glass mosaic.
- Natural stone and marble.

Recommended use:

- Waterproofing of bathrooms and showers.
- Spas and premises in permanently damp environments.
- Outdoor terraces and balconies.
- Pools and premises into direct contact with water.
- Cisterns and reservoirs into direct contact with water.
- Repair of cracked floors and renderings.
- Promotes adherence on existing ceramic wall tiles and on wood or metal substrates.

Coverage:

Bond coat:	
• One-layer application	
• Sylastic mortar	1.95 Kg / m ²
• Sylastic additive	0.65 Kg / m ²
Waterproofing:	
• Two-layer application	
• Sylastic mortar	3.90 Kg / m ²
• Sylastic additive	1.30 Kg / m ²
Mean thickness per sylastic layer: 1.5 mm	

sylastic			
SAP		Presentation	P/EU
100072729	sylastic mortar	24 Kg bag	1.00 p/kg
100072730	sylastic additive	8 Kg can	12.63 p/kg
100288372	50 m fiberglass mesh	50 m ² roll	2.49 p/m ²
100006210	outer angle	unit	8.16 p/u
100006211	inner angle	unit	8.16 p/u
100081532	5 ml waterproof band	5 m roll	4.44 p/m
100081531	10 ml waterproof band	10 m roll	4.23 p/m
100006221	50 ml waterproof band	50 m roll	4.08 p/m

Before using this product in any application not indicated in this catalogue, please perform a test or refer to the product's technical sheet.

WATERPROOFING

imperband

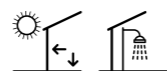

imperband is a waterproof sheet, specially designed for indoor waterproofing of ceramic wall and floor coverings.

It is a 0,5mm thick polymer membrane with a double thermoplastic polyolefin sheet and covered on both sides by non woven polyester fibers that allow it to be bonded to surfaces using cement-based adhesives. Ideal for use in new construction and refurbishment of showers and baths, and any indoor environment permanently affected by damp.

Certifications/Standards:

Avis technique: CSTB 13/16-1319

Features:

- Double thermoplastic polyolefin membrane covered on both sides by non woven polyester fibers.
- Maximum waterproofing with minimal thickness (0.5 mm).
- Direct installation of the tile on the sheet.
- Good chemical resistance.
- Quick and easy application.

Recommended use:

- Private bathrooms. Built in showers.
- Public toilets and showers.
- Spas and premises in permanently damp environments.
- Balconies and terraces smaller than 10 m².
- Do not use in outdoors surfaces greater than 10 m².

Installation:

- **imperband** sheet is compatible with type C2 cement-based adhesive as per EN 12004.
- In case of surfaces bigger than the length of the sheet, overlap two 10 cm sheets and bond with C2 adhesive.
- In waterproofing of floors, leave an excess of sheet of at least 10 cm in all the spots where floor meets the wall.
- Be extremely cautious when connecting the sheet to the drainage systems.
- Once the **imperband** sheet has been installed, cover with the chosen floor covering. Never leave exposed to direct sunlight.

Materials:

- Absorbent and non-absorbent ceramic tiles. Porcelain tiles with a water absorption < 0.5% as per EN-ISO 10545-3.
- Glass mosaic.
- Natural stone and marble.

Substrates:

- Cement covered floors and walls .
- Concrete slabs.
- Plasterboards.
- On anhydrite or plaster substrates apply **uniprim**, previously to the cement based adhesive

imperband

SAP		Presentation	P/EU
100276193	imperband	roll 30 m ² 720 m ² /pallet	14.28 p/m ²
100276212	imperband	roll 5 m ² 480 m ² /pallet	14.46 p/m ²

Before using this product in any application not indicated in this catalogue, please perform a test or refer to the product's technical sheet.



pool-deck

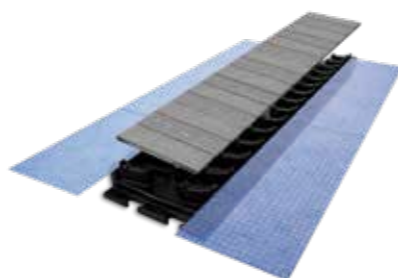
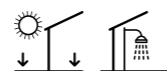

Drainage system for pools and terraces covered with porcelain tiles. This new water collection channel system is prepared to receive PORCELANOSA Grupo tiles and allows water to drain through the open joints between them. Compatible with any exterior waterproofing system, pool-deck replaces the traditional metal or plastic grates, completely changing the finish and durability of any outdoor flooring.

Available for 19.3 and 25 cm wide tile pieces. Professional system.

Features:

- Drainage through the open perimeter joint around the tile pieces. Drain joint width: 7mm
- Compatible with all butech exterior waterproofing systems: sylastic and lamitech n.
- Compact; only 55 mm thick channel plus tile.
- Light system, only 9 kg / m²
- High compressive strength: 2000 kpa

Recommended use:

- Drainage of interior and exterior flooring.
- Private and public showers.
- Terraces and pools
- Especially recommended for the following formats:
 - PAR-KER 193 x 1200 mm
 - PAR-KER 193 x 1800 mm
 - PAR-KER 250 x 1500 mm

Materials:

- Non-slip porcelain tile pieces
- STON-KER antislip
- PAR-KER antislip
- URBATEK antislip

Supports:

- Cement mortar screeds

pool-deck complements

pool-deck channel: 95 cm long channel with internal V-slope, which includes heat-sealed IMPERBAND waterproofing sheet over the eaves of the channel.

pool-deck adjustment Channel: Adjustment piece of different length measurements with internal V-slope, which includes heat-sealed IMPERBAND waterproofing sheet over the eaves of the channel. To complete the measurement required by the installation, these pieces will be available in the following measures: 15, 25, 35, 45, 55, 65, 75 and 85 cm.

pool-deck drain: Drain piece with internal V-shaped slope, which includes IMPERBAND waterproofing sheet heat-sealed over the eaves of the channel and a special drain designed for this system that withstands high pressures and is resistant to products commonly used in swimming pools.

pool-deck corner: Corner piece with internal V-slope, including IMPERBAND waterproofing sheet heat-sealed over the eaves of the channel.

pool-deck corner drain: Corner drain piece with internal V-slope, which includes heat-sealed IMPERBAND waterproofing sheet over the eaves of the channel and a special drain designed for this system that withstands high pressures and is resistant to products commonly used for swimming pools.

pool-deck side: Channel closure / start terminal that includes heat-sealed Imperband waterproofing sheet over the eaves of the channel.

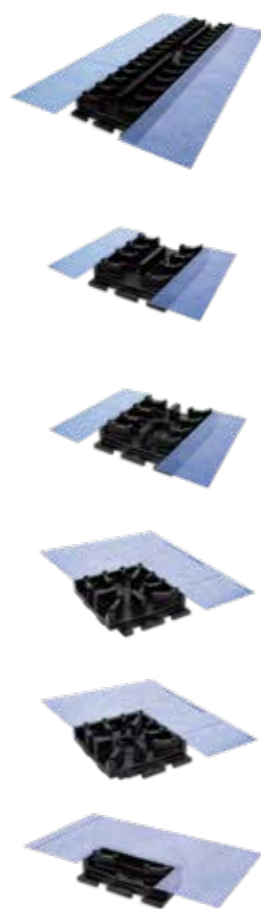

pool-deck 25 cm

SAP		P/EU
100284628	pool-deck channel 25X95	146.37 p/u
100284678	pool-deck adjustment channel 25X15	89.52 p/u
100284682	pool-deck adjustment channel 25X25	97.31 p/u
100284683	pool-deck adjustment channel 25X35	105.11 p/u
100284684	pool-deck adjustment channel 25X45	112.88 p/u
100284667	pool-deck adjustment channel 25X55	120.67 p/u
100284648	pool-deck adjustment channel 25X65	128.45 p/u
100284668	pool-deck adjustment channel 25X75	136.23 p/u
100284669	pool-deck adjustment channel 25X85	144.03 p/u
100284681	pool-deck drain 25X29,6	102.78 p/u
100284665	pool-deck corner 25X27,4	96.56 p/u
100284680	pool-deck corner drain 25X27,4	107.45 p/u
100284685	pool-deck side 25X6,5 male	96.56 p/u
100289060	pool-deck side 25X6,5 female	96.56 p/u

pool-deck 19.3 cm

SAP		P/EU
100284673	pool-deck channel 19,3X95	131.57 p/u
100284644	pool-deck adjustment channel 19,3X15	80.93 p/u
100284664	pool-deck adjustment channel 19,3X25	88.32 p/u
100284674	pool-deck adjustment channel 19,3X35	94.86 p/u
100284675	pool-deck adjustment channel 19,3X45	102.00 p/u
100284646	pool-deck adjustment channel 19,3X55	109.15 p/u
100284653	pool-deck adjustment channel 19,3X65	115.95 p/u
100284676	pool-deck adjustment channel 19,3X75	131.57 p/u
100284638	pool-deck adjustment channel 19,3X85	129.88 p/u
100284637	pool-deck drain 19,3X23,9	92.82 p/u
100284663	pool-deck corner 19,3X21,7	87.04 p/u
100284670	pool-deck corner drain 19,3X21,7	96.56 p/u
100284654	pool-deck side 19,3X6,5 male	87.04 p/u
100289037	pool-deck side 19,3X6,5 female	87.04 p/u

terrace drain



The **floor drain** from **butech** is a drain for terraces and outdoor floors. It features a wide dish around the grating, which ease the connection to waterproofing sheets. Available with horizontal and vertical outlet, it helps to solve easily and effectively outdoor waterproofing and drainage.

The 10 cm connecting piece between the grating and the drain can be cut, so that it can be installed with glass mosaics up to natural stones. Includes steel grating.

Recommended use:

- Drain designed for connecting with waterproofing sheet.
- Specially designed for **lamitech n** waterproofing outdoor terraces and floors.
- Vertical outlet.

Terrace drain complements

Terrace drain connection:

Clamp for fixing **lamitech n** waterproofing sheet to drain. Includes stainless steel clamp, rubber o-ring and 6 fixing screws.



Terrace drain features:

- 190 mm high drain.
- Discharge speed. 1.6 l/s.
- 75/110 mm vertical outlet.
- 36 cm diameter crown for **lamitech n** waterproofing sheet fixation.
- Includes u-bend.
- 143 x 143 mm steel grating.



bathroom drain



The **bathroom drain** from **butech** is a drain for built in shower trays. It features a wide dish around the grating, which ease the connection to the imperband waterproofing sheet. Available with horizontal and vertical outlet, it helps to solve easily and effectively indoor waterproofing and drainage.

The 10 cm connecting piece between the grating and the drain can be cut, so that it can be installed with glass mosaics up to natural stones. Includes steel grating.

Recommended use:

- Drain designed for connecting with **imperband** waterproofing sheet.
- Specially designed for waterproofing built in showers.
- Available with horizontal or vertical outlet

Bath drain complements

Bathroom drain connection:

Clamp for fixing imperband sheet to drain. Includes stainless steel clamp, rubber o-ring and 6 fixing screws.



Features for horizontal bathroom drain:

- 75 mm high drain.
- Discharge speed. 0.6 l/s.
- 50 mm horizontal outlet.
- 22 cm diameter crown for **imperband** fixation.
- Optional outlet for serial connections.
- Includes u-bend.
- 10 x 10 cm steel grating.



Features for vertical bathroom drain:

- 140 mm high drain.
- Discharge speed. 0.9 l/s.
- 50 mm vertical outlet.
- 26.5 cm diameter crown for imperband fixation.
- Includes u-bend.
- 10 x 10 cm steel grating.



Terrace drain			
SAP		Presentation	P/EU
100005827	75/110 vertical drain	1 ud/box	69.73 p/u
100005829	floor drain connection	1 ud/box	63.38 p/u

bath drain			
SAP		Presentation	P/EU
100005822	40/50 horizontal drain	1 ud/box	36.88 p/u
100005823	50 vertical drain	1 ud/box	41.07 p/u
100005825	bathroom drain connection	1 ud/box	20.20 p/u

Before using this product in any application not indicated in this catalogue, please perform a test or refer to the product's technical sheet.

Before using this product in any application not indicated in this catalogue, please perform a test or refer to the product's technical sheet.

butech anti-cracking mat



Decoupling sheet for floors undergoing low and medium movements.

This membrane reduces the transfer of tensions and stresses between the substrate and the flooring, protects the flooring against the appearance of cracks caused by sideways movements between the slabs forming the substrate and allows porcelain or natural stone flooring to be laid on substrates with medium and low movements. Especially recommended on floors built with timber panels.



Features:

- Closed-cell elastomer sheet coated on both sides with non-woven fibers that allow cement-based adhesives to be anchored.
- It allows for direct laying of ceramic tiles with cement-based adhesive types C2 S1 according to EN 12004.

Color:	White
Roll dimensions:	15 m ² 1500 x 100 cm
Roll weight:	12.35 kg/roll
Sheet thickness:	1.5 mm
Sheet density:	525 gr/m ²

Final use:

- Indoor and outdoor floor tile coverings
- Residential and public concurrence floor coverings with pedestrian traffic
- Floor coverings for commercial or industrial use with mechanical requirements, even with wheel circulation
- Floors with built-in heating
- Suitable for kitchens, bathrooms and water-bearing areas
- Suitable for floor renovations

We do not recommend the use of butech anti-cracking mat in:

- Indoor and outdoor walls
- Supports exposed to bending movements
- On structural joints or movement joints of the support

Materials:

- Stoneware and porcelain stoneware floors, even large formats.
- Natural stones and marbles, even large formats.

The use of butech anti-cracking mat is not recommended:

- Chemically resistant floor coverings
- Under parquet floors

butech anti-cracking mat

SAP		Presentación	P/EU
100227223	Roll 15 m ²	450 m ² / pallet	10.25 p/m ²

lamitech n



lamitech n is a multilayer polymer sheet, specially designed for outdoor floors decoupling. Protects tiles against substrate tensions, reducing the risk of breakage and piece lifting. Suitable for outdoor waterproofing.

Coextruded HDPE/EVAC membrane, with one side covered with polyester fibers and the other one with polyester entwined felt, that allows laying with cement-based adhesives. Absorbs tensions, reducing their transmission to the ceramic floor. Indoor and outdoor use.



Features:

- Multilayer HDPE/EVAC polymer membrane covered with polyester fibers.
- Maximum outdoors waterproofing with minimal thickness (3,4 mm).
- It allows for direct laying of ceramic tiles with cement-based adhesive.
- Good chemical resistance.
- Improves impact noise reduction.
- Quick and easy application.

Installation:

- **lamitech n** sheet is compatible with type C2 cement-based adhesive as per EN 12004.
- Place sheets side by side, without overlappings. In case of using it as waterproofer, proceed to sealing sheet joints with **sylastic** waterproof mortar and **lamiband 200** waterproof band..
- In waterproofing of floors, lengthen the waterproofing with **lami-band 200** at least 10 cm in all the spots where floor meets the wall.
- In movement joints, use flexible tape waterproof band.
- Be extremely cautious when connecting the sheet to the drainage systems.
- Once **lamitech n** has been installed, lay the chosen floor with compatible adhesives. Never leave exposed to direct sunlight.

Recommended use:

- Decoupling of balconies and terraces.
- Waterproofing of outdoor floors.
- Laying of ceramics on wood substrates.
- Laying of floor tiles on cracked substrates. Terrace refurbishing.
- Laying of ceramics on substrates which are not set yet or present residual damp.

Materials:

- Absorbent and non-absorbent ceramic tiles. Porcelain tiles with a water absorption < 0.5% as per EN-ISO 10545-3.
- Glass mosaic.
- Natural stone and marble.

Substrates:

- Cement or anhydrite covered floors.
- Concrete slabs.
- Existing floor tiles.
- Plywood boards.

lamitech n

SAP		Presentación	P/EU
100286750	lamitech n	5 m roll 150 m ² /pallet	16.40 p/m ²
100288347	lami-band 200 mm	30 m roll	4.22 p/m
100006221	50 ml waterproof band	50 m roll	4.08 p/m
100072729	sylastic mortar	24 Kg bag	1.00 p/kg
100072730	sylastic additive	8 Kg can	12.63 p/kg



MICRO-STUK

MICRO-STUK DESIGN

micro-stuk snow n, **206** | micro-stuk grey n, **208**
micro-stuk manhattan n, **210** | micro-stuk cement n, **212**
micro-stuk white n, **214** | micro-stuk beige n, **216**
micro-stuk moka n, **218** | micro-stuk wenge n, **220**

MICRO-STUK DESIGN

Handcrafted PORCELANOSA finish.
Make your project unique.



micro-stuk snow n

Outstanding decorative wall covering.
Interior.

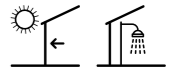

kit micro-stuk fine snow n
Smooth finish

100242470
285.62 p/kit

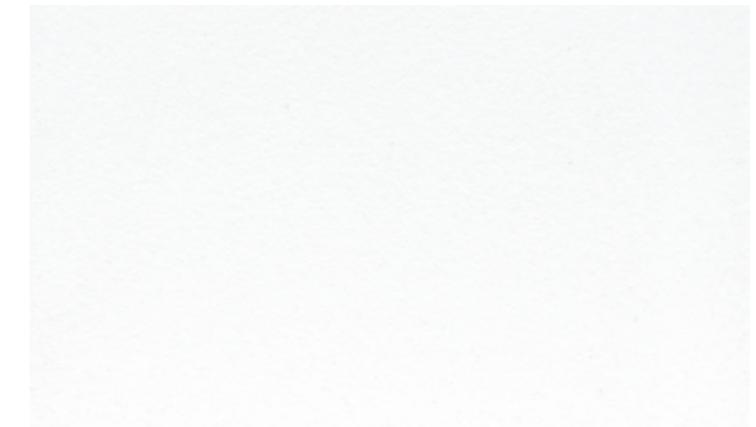

kit micro-stuk nature snow n
Rough finish

100242419
251.94 p/kit

Kit micro-stuk	primer-stuk n	base-stuk n	fine-stuk n	resin-stuk n	sealer-stuk n	protec-stuk n	decor-stuk n
micro-stuk fine n	0,5 L	10 Kg	2,5 Kg	3,9 Kg	0,5 Kg	1,2 Kg	0,78 L
micro-stuk nature n	0,5 L	10 Kg	-	2,9 Kg	0,5 Kg	1,2 Kg	0,6 L

micro-stuk design kits contain enough materials to cover at least 5 m² surface.

Colours are representative only and do not replicate the exact shade of the product. Please consult samples to choose colour.

MICRO-STUK DESIGN

Handcrafted PORCELANOSA finish.
Make your project unique.



micro-stuk grey n

Outstanding decorative wall covering.
Interior.

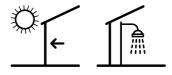

kit micro-stuk fine grey n
Smooth finish

100242460
264.97 p/kit

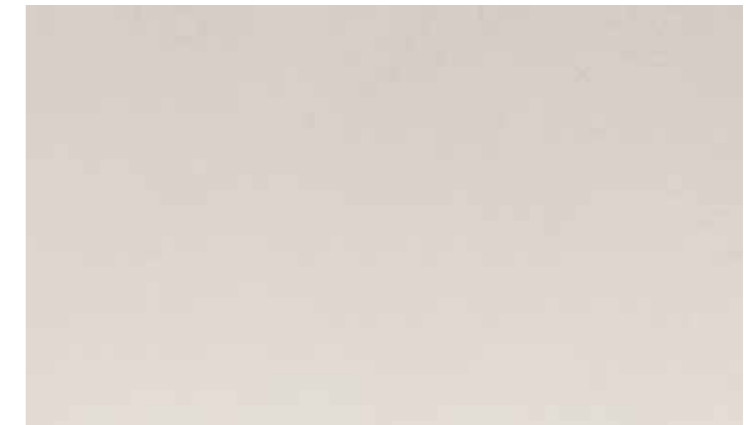

kit micro-stuk nature grey n
Rough finish

100242472
226.37 p/kit

Kit micro-stuk	primer-stuk n	base-stuk n	fine-stuk n	resin-stuk n	sealer-stuk n	protec-stuk n	decor-stuk n
micro-stuk fine n	0,5 L	10 Kg	2,5 Kg	3,9 Kg	0,5 Kg	1,2 Kg	0,16 L
micro-stuk nature n	0,5 L	10 Kg	-	2,9 Kg	0,5 Kg	1,2 Kg	0,15 L

micro-stuk design kits contain enough materials to cover at least 5 m² surface.

Colours are representative only and do not replicate the exact shade of the product. Please consult samples to choose colour.

MICRO-STUK DESIGN

Handcrafted PORCELANOSA finish.
Make your project unique.



micro-stuk manhattan n

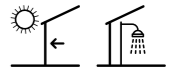

Outstanding decorative wall covering.
Interior.

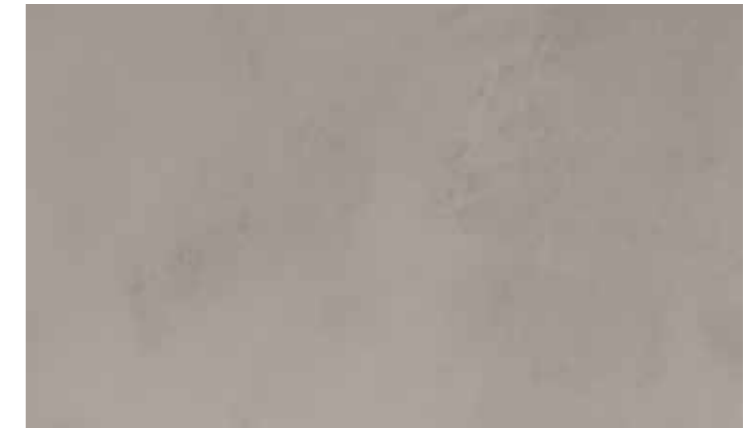

kit micro-stuk fine manhattan n
Smooth finish

100242451
264.97 p/kit



kit micro-stuk nature manhattan n
Rough finish

100242464
226.37 p/kit

Kit micro-stuk	primer-stuk n	base-stuk n	fine-stuk n	resin-stuk n	sealer-stuk n	protec-stuk n	decor-stuk n
micro-stuk fine n	0,5 L	10 Kg	2,5 Kg	3,9 Kg	0,5 Kg	1,2 Kg	0,22 L
micro-stuk nature n	0,5 L	10 Kg	-	2,9 Kg	0,5 Kg	1,2 Kg	0,17 L

micro-stuk design kits contain enough materials to cover at least 5 m² surface.

Colours are representative only and do not replicate the exact shade of the product. Please consult samples to choose colour.

MICRO-STUK DESIGN

Handcrafted PORCELANOSA finish.
Make your project unique.



micro-stuk cement n

Outstanding decorative wall covering.
Interior.

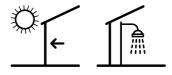

kit micro-stuk fine cement n
Smooth finish

100242481
264.97 p/kit



kit micro-stuk nature cement n
Rough finish

100242491
226.37 p/kit

Kit micro-stuk	primer-stuk n	base-stuk n	fine-stuk n	resin-stuk n	sealer-stuk n	protec-stuk n	decor-stuk n
micro-stuk fine n	0,5 L	10 Kg	2,5 Kg	3,9 Kg	0,5 Kg	1,2 Kg	0,49 L
micro-stuk nature n	0,5 L	10 Kg	-	2,9 Kg	0,5 Kg	1,2 Kg	0,38 L

micro-stuk design kits contain enough materials to cover at least 5 m² surface.

Colours are representative only and do not replicate the exact shade of the product. Please consult samples to choose colour.

MICRO-STUK DESIGN

Handcrafted PORCELANOSA finish.
Make your project unique.



micro-stuk white n

Outstanding decorative wall covering.
Interior.

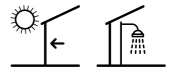

kit micro-stuk fine white n
Smooth finish

100242453
264.97 p/kit

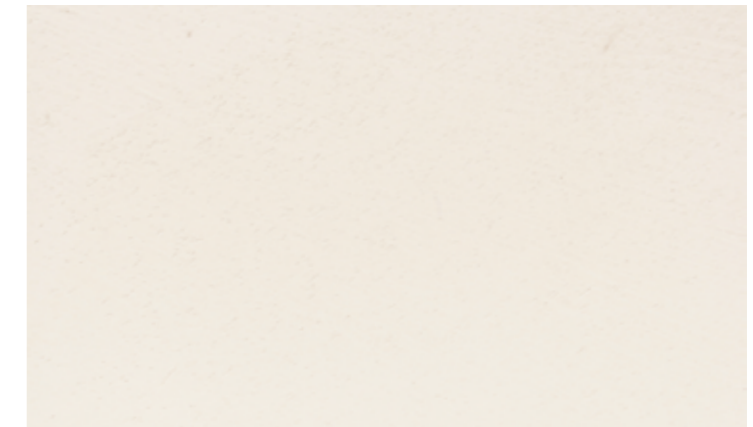

kit micro-stuk nature white n
Rough finish

100242490
226.37 p/kit

Kit micro-stuk	primer-stuk n	base- stuk n	fine- stuk n	resin- stuk n	sealer- stuk n	protec- stuk n	decor- stuk n
micro- stuk fine n	0,5 L	10 Kg	2,5 Kg	3,9 Kg	0,5 Kg	1,2 Kg	0,20 L
micro- stuk nature n	0,5 L	10 Kg	-	2,9 Kg	0,5 Kg	1,2 Kg	0,12 L

micro-stuk design kits contain enough materials to cover at least 5 m² surface.

Colours are representative only and do not replicate the exact shade of the product. Please consult samples to choose colour.

MICRO-STUK DESIGN

Handcrafted PORCELANOSA finish.
Make your project unique.



micro-stuk beige n

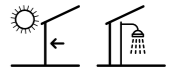

Outstanding decorative wall covering.
Interior.



kit micro-stuk fine beige n
Smooth finish

100242463
264.97 p/kit



kit micro-stuk nature beige n
Rough finish

100242429
226.37 p/kit

Kit micro-stuk	primer-stuk n	base-stuk n	fine-stuk n	resin-stuk n	sealer-stuk n	protec-stuk n	decor-stuk n
micro-stuk fine n	0,5 L	10 Kg	2,5 Kg	3,9 Kg	0,5 Kg	1,2 Kg	0,07 L
micro-stuk nature n	0,5 L	10 Kg	-	2,9 Kg	0,5 Kg	1,2 Kg	0,04 L

micro-stuk design kits contain enough materials to cover at least 5 m² surface.

Colours are representative only and do not replicate the exact shade of the product. Please consult samples to choose colour.

MICRO-STUK DESIGN

Handcrafted PORCELANOSA finish.
Make your project unique.



micro-stuk moka n

Outstanding decorative wall covering.
Interior.

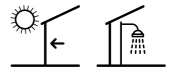

kit micro-stuk fine moka n
Smooth finish

100242492
264.97 p/kit



kit micro-stuk nature moka n
Rough finish

100242471
226.37 p/kit

Kit micro-stuk	primer-stuk n	base- stuk n	fine- stuk n	resin- stuk n	sealer- stuk n	protec- stuk n	decor- stuk n
micro- stuk fine n	0,5 L	10 Kg	2,5 Kg	3,9 Kg	0,5 Kg	1,2 Kg	0,15 L
micro- stuk nature n	0,5 L	10 Kg	-	2,9 Kg	0,5 Kg	1,2 Kg	0,09 L

micro-stuk design kits contain enough materials to cover at least 5 m² surface.

Colours are representative only and do not replicate the exact shade of the product. Please consult samples to choose colour.

MICRO-STUK DESIGN

Handcrafted PORCELANOSA finish.
Make your project unique.



micro-stuk wenge n

Outstanding decorative wall covering.
Interior.

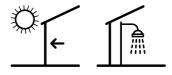

kit micro-stuk fine wenge n
Smooth finish

100242452
327.35 p/kit

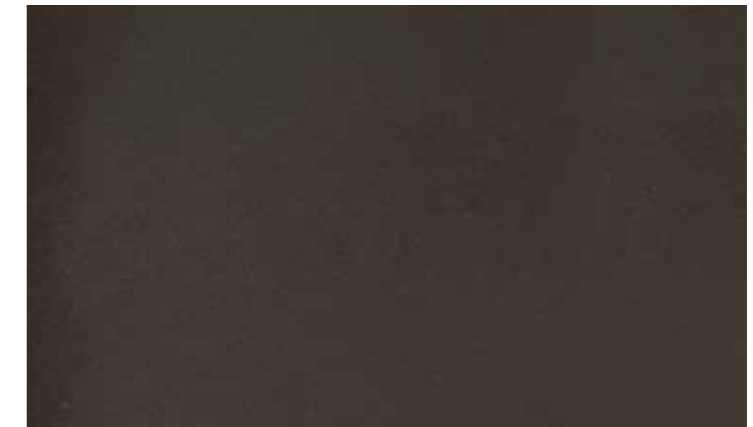

kit micro-stuk nature wenge n
Rough finish

100242480
261.41 p/kit

Kit micro-stuk	primer-stuk n	base- stuk n	fine- stuk n	resin- stuk n	sealer- stuk n	protec- stuk n	decor- stuk n
micro- stuk fine n	0,5 L	10 Kg	2,5 Kg	3,9 Kg	0,5 Kg	1,2 Kg	1,19 L
micro- stuk nature n	0,5 L	10 Kg	-	2,9 Kg	0,5 Kg	1,2 Kg	1,04 L

micro-stuk design kits contain enough materials to cover at least 5 m² surface.

Colours are representative only and do not replicate the exact shade of the product. Please consult samples to choose colour.

KEY

***Iconography**

Product name **CEMENT-BASED ADHESIVES**

Product family

Product picture

Product certifications and standards

Product features

Types of substrates where the use of the product is recommended

Types of applications where the use of the product is recommended

Types of materials where the use of the product is recommended

Product Coverage

Value

Type of packaging for the product

one-flex Premium

one-flex Premium is a type C2 TE S1 high-performance cement-based adhesive, as per EN 12004, for laying all kinds of ceramic tiles on the most used substrates in the building.

Very easy to use, one-flex premium can be prepared with a wide range of mixing water giving different properties to the adhesive: high wettability for large floor tiles or an excellent consistency for bedding thickness up to 15mm. Professional use.

Certifications/Standards:
EN 12004 C2 TE S1

Features:
Excellent adherence. Flexible.
Bonding material, with excellent mixing and application features.
High initial adherence and no sagging. Thixotropic.
Extended working times. Open time higher than 30 min.
Application thickness from 2 to 15 mm.
Broad spectrum in the percentage of mixing water:
one-flex premium white
Mixing water: 8.1 - 8.9 L per 25 kg bag
one-flex premium grey
Mixing water: 6.5 - 7.2 L per 25 kg bag

Recommended uses:
Floors and walls with rectified tiles
Large format indoor porcelain wall tiles
Large format interior porcelain floor tiles and outdoor use
High traffic floor tiles
Floor tiles on radiant heating
Pools and damp environments
On bonded facades, replace mixing water with **unilax** additive

Substrates:
Cement-based screeds
Cement render
Concrete slabs and floors
Anhydrite screeds, having previously applied **uniprim**
Plasters, having previously applied **uniprim**
Large-format ceramic brick
Pre-existing tiles/mosaic/stones*
Plasterboard panels
Cement-based panels
Mixed with **unilax**, acoustic insulation **fonopacr**

Materials:
Large format ceramic tiles
High-absorption ceramic tiles and stoneware
Porcelain tiles
Glass mosaic
Natural stone and marble not prone to staining

Coverage:
Small format and mosaic / Trowel U4: 2-3 kg/m²
Medium format / Trowels U6-U8: 3-5 kg/m²
Large format / Trowels U10-U12: 5-7 kg/m²

Regardless of our recommendations for use indicated for this adhesive, respect the installation regulations in force in each country.
* super-prim improves the adherence on polished ceramics and glossy finishing tiles
Before using this product in any application not indicated in this catalogue, please perform a test or refer to the product's technical sheet.

SAP	one-flex Premium	Presentation	Euro pallet	P/EU
100201526	one-flex Premium blanco	bag 25 kg	1000 kg/pallet	1.29 p/kg
100201543	one-flex Premium gris	bag 25 kg	1000 kg/pallet	1.23 p/kg
100277878	r-eco	bag 250 gr		1.02 p/u

*Iconography



Exterior floor



Exterior wall



Shower area



Slight pedestrian traffic



Interior floor



Interior wall



Moderate pedestrian traffic



PORCELANOSA Showrooms

ESPAÑA

A CORUÑA

A CORUÑA_SUMINISTROS VIA-MAR, S.L. · Médico Rodríguez, 18-20. +34 981 279 431
A CORUÑA_BETANZOS SUMINISTROS VIA-MAR, S.L. · Avda. Fraga Iribarne, s/n +34 981 772 190
CARBALLO_JESUS PEDROUZO S.L. · Valle Inclán 24, Bajo +34 981 701 120
CARNOTA_CAPELO GARCIA, MANUEL FELIPE · LG San Mamed, s/n. +34 981 857 081
CEE_B_FANDIÑO LADO, S.L. · CL Valdepeñas, s/n. +34 981 748 003 +34 981 748 004
FERROL_NEIRA Y ORTEGAL, S.L. · Carretera Catabois, 258. +34 981 326 532 +34 981 324 951
MUROS_ALMACENES CASTILLO DE MUROS, S.L. · Rosalía de Castro, 5. Pol. Ind. Muros +34 981 826 368
ORTIGUEIRA_NEIRA Y ORTEGAL, S.L. · Carretera C-642 s/n, Cuiña. +34 981 400 880
PUEBLA DEL CARAMIÑAL_PEREZ DOMINGUEZ PUEBLA, S.L. · Angustia, 30. +34 981 830 214
SANTA COMBA_ALMACENES SEROMAVI, S.L. · Avda. Santiago, 18. +34 981 880 104 +34 981 818 617
SANTIAGO DE COMPOSTELA_PORCELANOSA · General Pardiñas, 13-Bajo +34 981 569 230
SANTIAGO DE COMPOSTELA_PORCELANOSA · Rua Clara Campoamor, 13-15 (Montouto) +34 981 509 270
SANTIAGO DE COMPOSTELA_PORCELANOSA · Polígono Comercial Costa Vella +34 981 897 595

ÁLAVA

VITORIA-GASTEIZ -JORGE FERNÁNDEZ · Polígono de Jundiz. Paduleta, 53. +34 945 244 250
VITORIA-GASTEIZ -JORGE FERNÁNDEZ · Los Herrán, 30. +34 945 254 755 +34 945 259 668

ALBACETE

ALBACETE-PORCELANOSA · Avda. Gregorio Arcos, 32. (Pol. Campollano) +34 967 243 658 +34 967 193
465 VILLARROBLEDO_OLIVARES MAT. CONSTRUCCIÓN · Avda. Reyes Católicos, 168. +34 967 138 105

ALICANTE

ALCOY-SANEAMIENTOS COLON · Avda. de la Alameda, 10. +34 965 331 891 +34 965 524 210
ALTEA-ELDECO · Carretera N-332 Partida Cap Blanch, 38A. +34 966 874 360 +34 966 873 543
BENISSA-HIJOS DE JUAN RIBES · Avda. de la Estación, 2. +34 965 730 419
ELCHE-PORCELANOSA · Avda. Alicante, 105. +34 966 610 676 +34 966 610 700
JÁVEA-AZULEJOS JÁVEA · Liverpool, 4. +34 965 791 036
SAN JUAN-PORCELANOSA · Carretera Valencia, km 88. +34 965 656 200 +34 965 655 644

ALMERÍA

VÍCAR_PORCELANOSA · Parque Comercial Viapark, Parcela 1. +34 950 325 575 +34 950 338 651

ASTURIAS

GIJÓN-PORCELANORTE · S.L. Menéndez Pelayo 30. +34 984 396 462
OVIEDO-PORCELANOSA · Pol. Espíritu Santo. Calle Dinamarca, s/n. +34 985 791 526 +34 985 985 963

ÁVILA

ÁVILA_PAVIMARSA · Pol. Ind. Vicolozano - Parcela 2. +34 920 259 820 +34 920 259 821

BADAJOZ

HERRERA DEL DUQUE_JUBEL · Avda. Juan Carlos I s/n. +34 924 145 372
MÉRIDA_PORCELANOSA · Avda. Reina Sofia, 8. +34 924 330 218 +34 924 330 315
ZAFRA_MUNDO OBRAS · Pol. Ind. Los Caños, Calle Bodion, 27. +34 924 551 264 +34 924 551 264

BALEARES

CALA D'OR · MALLORCA_MACODOR · Carretera Calonge - Cala d'Or, km 1,5. +34 971 658 210
MANACOR · MALLORCA_MAT. DE CONSTRUCCION GALMES SA · Carrer Via Palma, 67. +34 971 553 050
MAHÓN_A PALLISER SL · Avda. Cap de Cavalleria, 1. +34 971 3573 00 +34 971 357 400
PALMA DE MALLORCA_PORCELANOSA · Gran Via Asima, 21. Pol. Son Castelló. +34 971 430 667
S. ANTONI PORTMANY_IBIZA PORCELANOSA · Avda. Llauradors, 7. Pol. Montecristo. +34 971 317 292
SOLLER_CAN SOLER · Del Mar, 193. +34 971 630 219 +34 971 632 311

BARCELONA

STA COLOMA DE GRAMANET_ÁLANTA SA · Ctra de la Roca km 5,6. +34 933 919011
BARCELONA_AZULEJOS SAN ANDRÉS · Plaça Mossen Clapes, 2-3. +34 933 455 102 +34 933 461015
BARCELONA_GIL DE NAPOLÉS - C/ Napolés. 87Barcelona. 655906329
BARCELONA_GRESS ARGENTONA · Pj Amics Argentona 2, Barcelona. +34 937 414716
CABRERA DE MAR_ORMAT · Carretera de Vilassar-Argentona km.1. +34 937 591 139 +34 937 502076
CALAF_PLANELL · Carretera Manresa km 31. +34 938 698 750 +34 938 600 181
CANOVELLES_COMERCIAL MAESTRO CANET · Pol. Can Castells, Nau 7-8. +34 938 466 568
CANTARA BARCELONA · C/ Valencia, 312, Barcelona. +34 935 216996
CANTARA SABADELL · Avinguda Rafael de Casanova, 24, Sabadell, Barcelona, +34 935 216991
CANTARA SANT FRUITOS · Pol. Casanova nau 2-7 · Ctra de Manresa a Berga Km 1. +34 935 216992
CORNELLA_LOFT CUINA · Carrer La Miranda, 6-8 +34 934 743 793 +34 934 741 305
CASSERES_MATERIALS CASSERRE · San Rafael +34 938 213 770
CUBELLES_MA-CO · Carrer Penedes-C/La Selva Pol.Ind.Les Salines +34 938 954 141 +34 938 954 142
CASTELLDEFELS_INDECOR FELS SL · AV · CONSTITUCION Nº 71 NAVE 3. +34 936 342507
GIORNELLA_ANTONI PONT · Carrer Farguell, 31. +34 938 228 088 +34 938 250 786
L'HOSPITALET DE LLOBREGAT_PORCELANOSA · Ciències, 65. Gran Via l'Hospitalet +34 932 642 500
MATARÓ_MARESME GRES · Carrer Sant Isidor, 78 +34 931 615 015
MATARÓ_ROSA JORDANA RABETLLAT · Carrer de Montserrat, 7 +34 937 903 089
PALAU SOLITA I PLEGAMANS_COMERCIAL SOLSAN · Cami Reial, 109. +34 938 648 125 +34 938 649617
PINEDA DE MAR_AMARGANT · Carrer Santiago Rusiñol, 96. +34 937 671 416 +34 937 627 488
POL DE MAR_AMARGANT · Passeig Parc. 1. +34 937 600 112 +34 937 600 411
SANT SADURNÍ D'ANOIA_COMERCIAL STC · Rambla Generalitat, 59. +34 931 593 137 +34 931 615 015
TARADELL_JODUL · Carretera de Vic, km 5,8 +34 938 800 800 +34 938 126 054
TORELLÓ_ARQUIMATT MATERIALS I DECORACIÓ · Carrer Sant Jordi, 16. +34 679 531 877
SANT BOI DE LLOBREGAT_GARRO · Ctra. Sta. Creu de Calafell, km 10,7. +34 936 545952 +34 938400620
SANTA MARIA DE PALAUTORDERA_JRIFERA MAGATZEM CONSTRUCCIÓ · Carretera Antigua Via Provincial, 20 ST.PERE DE RIBES-SUMCO · Carretera de Barcelona, C-246 km. 42,4. +34 938 933 066
VIC_CORRETTJA · Carrer Mas de Bigas, 8-26. +34 938 854 261 +34 938 894 733
VILAFRANCA DEL PENEDÉS_FERRETI I CASULLERAS · C/Sant Martí, 2. +34 93 890 14 19 - +34 93 8170353
VILANOVA DEL CAMÍ_PLANELL · Carretera Vilafranca 108-111. +34 938 060 240 +34 938 060 239

BURGOS

BURGOŞ-BIGMAT FONTECHA · Alcalde Martín Cobos,15. Nave 5 y 6. +34 947 485 153 +34 947 483 941
MIRANDA DE EBRO-JORGE FERNÁNDEZ · Camino Fuente Basilio, s/n. +34 947 323 351 +34 947 314 589

CÁCERES

CÁCERES_PORCELANOSA · Avda. Juan Pablo II, 130. +34 927 236 337 +34 927 236 205
MORALEJA_BIGMAT CAYUELA · Avda. Extremadura, 26. +34 927 515 198 +34 927 147 266
NAVALMORAL DE LA MATA_MAGERVYSA · Calle Rio Salor, 83. +34 927 535 234 +34 927 535 575

CÁDIZ

ALGECIRAS_PORCELANOSA · Carretera de Málaga, km 109. +34 956 635 282 +34 956 635 285
EL PUERTO STA. MARÍA_PORCELANOSA · Pol. El Palmar. Ctra. Madrid-Cádiz, km 653,2. +34 956 540084
SAN FERNANDO_PORCELANOSA · Polígono Tres Caminos, s/n. +34 956 592 360

CANTABRIA

SANTANDER_PORCELANOSA · Avda. Parayas, s/n. +34 942 352 510 +34 942 352 638

CASTELLÓN

CASTELLÓN_PORCELANOSA · Parque Comercial Estepark / Av. E.Gimeno s/n. +34 964 506 800
VINAROZ_PORCELANOSA · Carretera N-340, km 1.050,1. +34 964 400 944 +34 964 400 650

CEUTA

CEUTA_BAEZA · Ampliación Muelle de Poniente, 96. +34 956 511 312 +34 956 511 309

CIUDAD REAL

CIUDAD REAL_PORCELANOSA · Carretera de Carrión, 11. +34 926 251 730 +34 926 255 741
LA SOLANA_LOS PEPOTES · Calle Emilio Nieto, 39. +34 926 63 15 80 +34 926 63 38 56

CÓRDOBA

CÓRDOBA_PORCELANOSA · Carretera N-IV, km 404. Pol. de Torrecilla. +34 957 760 024 +34 957 760 123
LUCENA_NEIKU CONCEPT · Avda. Miguel Cuenca Valdivia, 6. +34 957 513 702
MONTILLA_ALMACENES MANOLIN Y LUIS S.L. · +34 957651509 +34 957653253

CUENCA

CASAS DE HARO_MAT. DE CONSTRUCCIÓN MARTÍNEZ ORTEGA · Calle 2 de Mayo, 28 +34 969 380708
CUENCA_VICOSAZ · Hermanos Becerril, 6 bajo. +34 969 233 200 +34 969 234 475
TARANCÓN_VICENTE DE LOS RIOS · Avda. del Progreso, 19. +34 969 321 323 +34 969 321 334
VILLANUEVA DE LA JARA_ALMACENES PAÑOS · Camino de Rubielos, 8. +34 967 498 000

GERONA

CANET DE LA TALLADA_SERVIMAT INICIATIVES · Carretera C-31 km. 354 +34 972 780 524
ESCLANYÀ BEGUR_MAT. CREIXELL · C/Palafugell Regencos. Pol. ind. Riera Esclanya, 1. +34 972 300 628
GIRONA_PORCELANOSA · Carretera Barcelona 120-122-124. +34 972 964 141
LLORET DE MAR_CARMONA · Carretera de Lloret_Vidreres 2,1. +34 972 372 710 +34 972 349 763
MONT-RAS_MERCAMAT · Carretera C-31 km. 329,8. +34 972 612 027 +34 972 302 146
PALAMOS_TG NOVA ARQUITECTURA · Avgda. Catalunya,91 +34 972 312 250 +34 972 312 249
SARRIA DE TER FERRER_CERVIÀ · Avgda. de França, 192. +34 972 173 442 +34 972 173 456
VILA-SACRA_FRIAS MATERIALS · Carrer Castelló, 72. +34 972 670 073 +34 972 673 071

GRANADA

ARMILLA_TECMACER · Avda. San Rafael (Junto Sprinter). +34 958 253 081 +34 958 183 367

GUIPÚZCOA

SAN SEBASTIÁN_JORGE FERNÁNDEZ · Pol. Ind. Belartzta. Fernando Múgika, 15. +34 943 376 966 +34 943 376 841

HUELVA

HUELVA_PORCELANOSA · Polígono La Paz Naves 1-5 +34 959 543 600 +34 959 237 951

HUESCA

AINSA_COMERCIAL CAMPODARVE · Pol. Ind. Sobrarbe, Naves 11 y 12. +34 974 500267 +34 974 500865
FRAGA_BERGES CENTRO COMERCIAL · Avda. Aragón, 70. +34 974 471 439 +34 974 471 439
HUESCA_PORCELANOSA · Pol. Sepes. Calle Ronda la Industria 1-3 Nave C. +34 974 242 738

JAÉN

ALCALA LA REAL_PAVIMENTOS AZUGRISA · Pol. Ind. Fte. Granada Vial II. +34 953 582 963
JAÉN_PORCELANOSA · Polígono Olivares. Carretera Bailén-Motril, km 323. +34 953 280 757 +34 953 284 035
LINARES_HERNÁNDEZ GÁMEZ · Ctra. Torreblascopedro s/n. +34 953 693 423 +34 953 693 444
ÚBEDA_HERNÁNDEZ GÁMEZ · Avda. de la Libertad, 88. +34 953 795 168 +34 953 795 168

LA RIOJA

LOGROÑO_RIOJACER · Avda. de Burgos, 43-45. +34 941 286 021 +34 941 202 271

LAS PALMAS

LAS PALMAS DE GRAN CANARIA_PORCELANAS Y PAVIMENTOS CANARIOS · Avda. Mesa y López, 61 +34 928 472 949 +34 928 472 944

LEÓN

PONFERRADA_DISEÑARTE BIERZO, S.L. · Avda. Galicia 380. +34 987 455 870
SAN ANDRÉS DEL RABANEDO_PORCELANOSA · Carretera León-Astorga, km 3,5 +34 987 801 570 +34 987 801 475

LÉRIDA

BALAGUER_J. FARRÉ · Carrer Urgell, 39. +34 973 445 765 +34 973 445 072
EL PONT DE SUERT_PRETENSADOS RIBERA · Ctra. N-230 km 124,5. +34 973 690 063 +34 973 690 400
LLEIDA_MATERIALS GERMANS MAURI · Carrer Princep de Viana, 36. +34 973 232 139 +34 973 247 943
LLEIDA_PUJOL ELEMENTS · Carrer Tarragona, 40. +34 973 202 350 +34 973 203 113
SOLSONA_MATERIALS JORDI VILAR · Carretera Manresa, s/n km.50. +34 973 482 077 +34 973 482 373
TARREGA_NOUMAG · Júpiter, 7 (Pol. Ind. La Canaleta) +34 607 497 330
VIELHA_PRETENSADOS RIBERA · Carretera França, 40. (Mig Aran) +34 973 641 460 +34 973 642 271

LUGO

CHANTADA_SONIA GOMEZ GOMEZ · Juan XXIII, Bajo 22 +34 982 441 249 +34 982 440 331
FOZ_ALMACENES BAHIA, S.L. · Maestro Lugilde, 6. +34 982 140 957 +34 982 132 065
LUGO_ARIAS NADELA, S.L. · Tolda de Castilla, s/n. +34 982 245 725 +34 971 662 816
LUGO_ARIAS NADELA, S.L. · Crta. N-VI, Km. 498 (Pol. Do Ceao) +34 982 221 254
XOVE_ESTABLECIMIENTOS REY, S.L. · Avda. Diputación, 88. +34 982 592 006 +34 982 592 071

MADRID

ALCORCÓN_PORCELANOSA · Carretera N-V, km 15,5. Parque Oeste de Alcorcón +34 916 890 172
LEGANÉS_PORCELANOSA · Avda. Recomba, 13. Pol. la Laguna Salida 53 - M50 +34 914 819 200
MADRID_EL CORTE INGLÉS CASTELLANA · Paseo de la Castellana, 85. +34 671 708 692
MADRID_PORCELANOSA · Ortega y Gasset, 62. Esq. Conde Peñalver +34 914 448 460 +34 914 025 111
MADRID_PORCELANOSA · Alcalá, 514. +34 917 545 161 +34 917 545 555
SAN SEBASTIÁN DE LOS REYES_PORCELANOSA · Plaza del Comercio, 17. +34 916 623 232

PORCELANOSA Showrooms

ESPAÑA

MÁLAGA

MÁLAGA_PORCELANOSA · Victoria de los Ángeles, 1. +34 952 241 375 +34 952 240 092
MARBELLA_PORCELANOSA · Ricardo Soriano, 65. +34 952 826 868 +34 952 822 880
NERJA_PAVISER NERJA, S.L. · Pol. Pto. Limpio Maz. 3 Parcela 12. +34 952 524 223 +34 952 524 223
VÉLEZ-MÁLAGA_MATERIALS MUÑOZ PÉREZ SL · Ferrocarril, 2. +34 952 507 879 +34 952 504 760

MELILLA

MELILLA_FERRETERIA MODERNA E HIJOS, S.L. · Paseo Marítimo Mir Berlanga, 19. +34 952 671 144

MURCIA

MURCIA_PORCELANOSA · Avda. Juan de Borbón, s/n. Parque Comercial Thader +34 968 879 527

NAVARRA

CINTRUÉNIGO_CERÁMICAS CECILIO CHIVITE · Pol. Ind. s/n. Variante N-113. +34 948 811 973
NAVARRA_MULTIVA BAJA MONTEJO CERÁMICAS · Pol. Ctra. Tajonar, Calle-A, Naves 2- 4 +34 948 239
065 PAMPLONA_MONTEJO CERÁMICAS· Navas de Tolosa, s/n. +34 948 224 000 +34 948 226424
TUDELA_MONTEJO CERÁMICAS · Ctra. Tudela -Tarazona, Pol. Centro Servicios Tudela +34 948 848 365

ORENSE

CARBALLIÑO_JOSE R. PITEIRA, S.L. · Avda. Julio Rodríguez Soto, 63. +34 988 271 071 +34 988 274 780
OURENSE_BLANCO QUINTAS, S.A. · Avda. Otero Pedrayo, 8. +34 988 391 478
VERIN_MAT. DE CONSTRUCCION ER-CA, S.L. · Avda. de Portugal, 44. +34 988 411 030 +34 988 411 801

PALENCIA

PALENCIA_CANTALAPIEDRA · La Puebla, 2. +34 979 706 421 +34 979 702 652

PONTEVEDRA

A ESTRADA_DALARJO, S.L. CL · Alto de la Cruz, s/n +34 986 570 489 +34 986 570 610
DENA - MEAÑO PREFABRICADOS DENA, S.L. RUA DE GALICIA, 24 +34 986 743 121 +34 986 745 131
LALÍN_ALMACENES CANDA, S.L. · Monserrat, 36-39. +34 986 780 184 +34 986 782 301
O GROVE PREFABRICADOS DENA, S.L. C/ALEXANDRE BOVEDA, 82 +34 986 702 041 +34 986 733415
SEIXO, MARÍN_SANEAMIENTOS ROSALES, S.L. · Avda. Doctor Otero Ulloa, 1. +34 986 702 041
SILLEDA_ARCOLAR 2000, S.L. · Rua de Venezuela, 40. +34 986 580 114 +34 986 592 513
VIGO_SANEAMIENTOS ROSALES, S.L. · García Barbón, 139 B. +34 986 228 806
VILAGARCIA DE AROUSA_SANEAMIENTOS GANDARA · Avda. La Marina, 126-128 Bajo +34 986 506 640

SALAMANCA

VILLARES DE LA REINA_PORCELANOSA · Pol. Villares. Ctra. Salamanca-Valladolid, km 2,2 +34 923243811

SEGOVIA

EL ESPINAR_SEGOCER · Carretera Madrid - La Coruña, km 64. +34 921 172 426 +34 921 171 828
SEGOVIA_SEGOCER · José Zorrilla, 134. +34 921 444 122

SEVILLA

ESTEPA_MATAS INTERIORISMO SL · Avda. Andalucía. Salida Málaga. +34 955 915 937 +34 955 915 938
LORA DEL RÍO_HERNÁNDEZ CARBALLO · Betis s/n. +34 955 800 473 +34 955 801 439
SEVILLA_PORCELANOSA · Tipografía, s/n. Pol. Industrial La Negrilla. (A-92 dir. Granada) +34 954 260540
TOMARES_PORCELANOSA · San Roque, s/n. Polígono El Manchón. +34 954 152 792 +34 954 153 188

SORIA

MATERIALES ODORICIO · Pol. las Casas-II. Calles A y J, Parcela 201 +34 975 233 228 +34 975 232 188

STA. CRUZ DE TENERIFE

STA. CRUZ DE TENERIFE_PORCELANAS Y PAVIMENTOS CANARIOS · Avda. 3 de Mayo, 18. +34 922 209 595

TARRAGONA

ALCOVER_EXPOMAT ALCOVER · Tramuntana, s/n. (Polígono Roques Roges) +34 977 760 476
EL VENDRELL_COMERCIAL STC · Carrer Terrissaires, 1. +34 977 661 951
EL VENDRELL_VIUDA DE ANTONIO FONT · Carrer de Valls 12. +34 977 660 794 +34 977 662 217
LES BORGES DEL CAMP · EXPOMAT LES BORGES · Ctra Alforja s/n. 660105371
MORA LA NOVA_COMERCIAL LLAURADO · Carretera de Tivissa, s/n. +34 977 400 387 +34 977 400 052
RODA DE BARA_CONSTRUCCIONS CIURO · Acceso a Roda de Bara km 1. +34 977802951 +34 977802012
TARRAGONA_MATERIALS GISBERT · Carrer Francesc Macià, 4. +34 977 242 363
TARRAGONA_TINALEX ARTE · Carretera Valencia, 202 0
TARRAGONA_TINALEX ARTE · Carretera Pont d'Armentera, 1 0
TORTOSA_MATERIALS GISBERT · Carretera Gandesa km 3,5. +34 977 500 306 +34 977 501 550
VALLS_RAMON MAGRIÑA BATALLA · Carrer Montblac, 14. +34 977 600 210 +34 977 603 302

TOLEDO

TOLEDO_PORCELANOSA · Pol. Ind. Santa María Benquerencia, C/del Río Marchés,123. +34 925 232 402

VALENCIA

ALBUIXECH_PORCELANOSA · Avda. del Mediterráneo, Parcela 6. Pol. ind. Mediterráneo. +34 961 417 227
REQUENA_PORCELANOSA REQUENA · Carmen, 6 - Bajo. +34 960 11 56 67
SEDAVÍ_PORCELANOSA · Avda. Mediterráneo, s/n. Zona Comercial Sedavi. +34 963 185 021
VALENCIA_PORCELANOSA · Colón, 58. +34 963 530 230 +34 963 531 688

VALLADOLID

VALLADOLID_CANTALAPIEDRA · Carretera de Soría A-24, km 5,5. +34 983 217 010 +34 983 200 921

VIZCAYA

AMOREBIETA_BILBU · Barrio Boroa, s/n. +34 946 731 158 +34 946 733 265
BILBAO_BILBU · Alameda Recalde, 39 - 41 +34

PORCELANOSA Showrooms

INTERNACIONAL | INTERNATIONAL

ALEMANIA
ACHERN_E.WERTHEIMER GMBH · +49 07841 6309 1300
ALZEY_J.N.KOEBIG GMBH · +49 6731 4880
ASCHAFFENBURG_KALKWERKE · +49 (0) 60 213 601 62 +49 (0) 60 213 602 93
BAD SALZUFLEN_W.LINNENBECKER GMBH · +49 (0) 5222 / 5301 221 +49 (0) 5222 / 5301 209
BADEN BADEN_E.WERTHEIMER GMBH · +49 (0) 7221 50020 +49 (0)722117080
BALLENSTEDT_FLIESEN SCHREIBER · +49 39485 95201
BAUTZEN_FLIESEN LEHMANN GMBH · +49 (0) 3591 / 3726 32 +49 (0) 351 / 8931420
BAYREUTH_FLIESEN EHRlich & CO. GMBH · +49 (0) 9 21 / 15 12 799-0
BERGISCH GLADBACH_SCHMIDT-RUDERSDORF GMBH & CO · +49 (0) 2204 / 4007 0 771 +49 (0) 3320 / 854715 BERLIN_FLIESENPARADIES GLAESKE + SEFZIG GMBH · +49 (0) 30 650 737 0
BERLIN_FLIESENPARADIES GLAESKE + SEFZIG GMBH · +49 (0) 30 565 555 90
BERLIN_KERANA KERAMIK- UND NATURSTEINHANDEL GMBH · +49 (0)30 318683-16/-19
BERLIN_W.LINNENBECKER GMBH & CO. KG · +49 (0) 30 / 756 888 +49 (0) 30 / 756 88 756
BONN-BUSCHDORF_SCHMIDT-RUDERSDORF- BONN · +49 02 28 - 55 916-0
BOTTRUP_W.LINNENBECKER GMBH & CO. KG · +49 (0) 2041 / 7958 13 +49 (0) 2041 / 7958 10
BRAND-ERBISDORF_FLIESEN THOMAS GMBH · +49 (0) 37322 18 0
BREMEN_W.LINNENBECKER GMBH & CO. KG · +49 420252190
BURG_WIEDEMANN INDUSTRIE UND HAUSTECHNIK GMBH · +49 39163103513
BURGSTÄDT_FLIESEN THOMAS GMBH · +49 (0) 3724 / 1856 0 +49 (0) 3724 / 1856 70
DORTMUND_W.LINNENBECKER GMBH & CO. KG · +49 (0) 231 / 562 090 22 +49 (0) 231 / 562 090 88
DÜSSELDORF_SCHMIDT RUDERSDORF DÜSSELDORF · +49 (0) 211 6350112
DÜSSELDORF_SCHMIDT RUDERSDORF VIERSEN · +49 (0) 2162 816360
EISENACH_FLIESENZENTRUM GMBH ERFURT · +49 (0) 3691 882175
EISENBERG_J.N.KOEBIG GMBH · +49 6351 1450
EISINGEN_FLIESENWELT EISINGEN GMBH · +49 (0) 9353 98 46 357 +49 (0) 9353 98 46 359
ELTERLEIN_MIRKO GLEISS · +49 (0) 37349 / 7305 +49 (0) 37349 / 6093
ERFURT_FLIESENZENTRUM GMBH ERFURT · +49 3614270720
ERKRATH_W.LINNENBECKER GMBH · +49 (0) 211 / 92503 19 +49 (0) 211 / 92503 34
FRIEBURG_GÖTZ & MORIZ GMBH · +49 (0) 76 145 180 +49 (0) 76 145 711 2
FULDA_OSWALD FLIESEN UND SERVICE GMBH & CO KG · +49 (0) 66 194 151 0 +49 (0) 66 194 151 40
GERA_BAUSTOFFE GEBRLÖFFLER GMBH · +49 (0) 365 430 701 9 +49 (0) 365 430 701 4
GERA_FLIESEN THOMAS GMBH · +49 (0) 365 55285-0
GÖRLITZ_FLIESEN-PEDERSEN GMBH · +49 (0) 3581 / 402809 +49 (0) 3581 / 409166
GOTHA_FLIESENZENTRUM GMBH ERFURT · +49 (0) 3621 5144880
GÖTTINGEN_F+B FLIESEN UND BAUSTOFF MARKT · +49 551 998710
GREIZ_BAUSTOFFE GEBRLÖFFLER GMBH · +49 36 61 / 70 50-0
HAMBURG -LURUP_CROONEN FLIESENHANDEL GMBH · +49 (0) 40 / 83383 377 +49 (0) 40 / 83383 301
HANNOVER_W.LINNENBECKER GMBH & CO. KG · +49 (0) 511 / 438 900
HEIDENAU_FLIESEN EHRlich & CO. GMBH · +49 (0) 35 29/ 52 85-0
HOF_FLIESEN THOMAS GMBH · +49 (0) 9281 86005-0
HUNGEN_MÜHL 24 · +34 (0) 6402 5200-0
JENA_FLIESENZENTRUM GMBH ERFURT · +49 (0) 3641 - 53257-0
KIEL_HEINRICH'S FLIESENMARKT GMBH · +49 (0) 431537340 +49 (0) 431529141
KOBLENZ_J. N. KÖBIG GMBH KOBLENZ · +49 (0) 26 198 169 20 +49 (0) 26 198 169 10
KRANICHFELD_MÜHL 24 KRANICHFELD · +49 (0) 36 450 330 +49 (0) 36 450 332 89
LAUF A. D. PEGNITZ_FLIESEN EHRlich & CO. GMBH · +49 (0) 91 23/ 97-11-0
LEIPZIG_FLIESEN THOMAS GMBH · +49 (0) 341 308558-0
LEIPZIG_GRAMER GMBH · +49 341 2346430
LEVERKUSEN_SCHMIDT-RUDERSDORF- LEVERKUSEN +49 02 14 - 8 68 13 0 +49 02 14 - 8 68 13 3
LÖBNITZ_SACHSENKERAM GBR · +49 (0) 34208 / 7400 +49 (0) 34208 / 7400
LÖRRACH_GÖTZ & MORIZ GMBH · +49 7621 4007100
LÜBECK_HEINRICH'S FLIESENMARKT GMBH · +49 (0) 451896669 +49 (0) 4518973494
MAINZ_J. N. KÖBIG GMBH MAINZ · +49 061 316 943 10 +49 061 316 942 75
MAINZ_J.N.KOEBIG GMBH · +49 6131694328
MESCHEDI_W.LINNENBECKER GMBH & CO. KG · +49 (0) 291 / 952 82 21 +49 (0) 291 / 952 82 82
MÜNCHEN_CERAMICAS OHG · +49 (0) 89 318 280 0 +49 (0) 89 318 280 20
MÜNSTER_W.LINNENBECKER GMBH & CO. KG · +49 (0) 251 / 979 12 21 +49 (0) 251 / 979 1220
NÜRNBERG/HAFEN_HEINRICH CHRIST GMBH & CO. KG · +49 (0) 91 164 318 0 +49 (0) 91 164 318 50
OFFENBURG_MAIER + KAUFMANN GMBH · +49 (0) 78196780 +49 (0)781967890
POTSDAM_KERANA KERAMIK- UND NATURSTEINHANDEL GMBH · +49 (0) 33208 547-0 +49 (0) 03381 7304501 PULHEIM_SCHMIDT RUDERSDORF PULHEIM · +49 (0) 2238 839790
RADEBEUL_FLIESEN EHRlich & CO. GMBH · +49 (0) 351 / 89314 10 +49 (0) 351 / 89314 20
SAALFELD_FLIESENZENTRUM GMBH ERFURT · +49 (0) 3671 52800
SCHRAMBERG_SULGEN ARMBRUSTER GMBH · +49 (0) 7422 28008-0 +49 (0) 7422 28008-20
SCHRIESHEIM_FLIESEN GALERIE SENGEWITZ · +49 6203 955330 +49 6203 955 33 29
SCHWARZENBERG_FLIESEN THOMAS GMBH · +49 (0) 3774 13930 30
SPEYER_SCHULTZ BAUZENTRUM GMBH & CO. KG · +49 6232/ 64620 +49 6232/ 646250
STEINACH_MAIER + KAUFMANN GMBH · +49 (0)7832 - 796 0
TRIER_SCHOLTES HANDELS GMBH · +49 651 9186611
UNTERGRUPPENBACH_KONZ & SCHAEFER HANDEL GMBH · +49 (0) 71312037480 +49 (0) 71312037489
VÖLKLINGEN_NIEDERER GMBH +49 (0) 68 989 802 21 +49 (0) 68 989 802 30
WAIBLINGEN_KONZ GMBH · +49 (0) 7151149200 +49 (0) 710510149-209
WÜRSELEN_SCHMIDT-RUDERSDORF- WÜRSELEN · +49 (0) 24 05 - 41 38 50 +49 (0) 24 05 - 41 38 55
ZWETHAU_GRAMER GMBH · +49 (0) 3421 / 7327 18 +49 (0) 3421 / 7326 73

ALBANIA
TIRANA_ALBA CERAMICA · +355 4 83 00 084 +355 4 83 00 084
TIRANA_ALBA CERAMICA PORCELANOSA GRUPO · +355 4 22 33 817 +355 4 22 33 817

ANGOLA
LUANDA_PORCELANOSA ANGOLA · +244 928463705 +244 222372374

ARABIA SAUDÍ
AL AHSA (Al-Sharqiyya)_KHALED AL ANSARI SHOWROOM · +966 3 5892888 +966 3 5817043
DAMMMAM (Al-Sharqiyya)_KHALED AL ANSARI-VALENCIA SHOWROOM · +966 3 8180355
DAMMMAM_MANART AL ANDALOS DAMMMAM · (+)966 12 6768441
Hafuf_Manart Al Andalos Al Ahsa · (+)966118102824
JEDDAH_MANART AL ANDALOS JEDDAH · (+)966 12 6768443 (+)966 12 6768440
RIYADH_MANART AL ANDALOS RIYADH · (+)966 11 8102512
RIYADH_MANART AL ANDALOS RIYADH · (+)966 11 4568383
DAMMMAM_MOHAMMED M. AL DOSSARY STORES · 38348681 38340086
RIYADH_MOHAMMED M. AL DOSSARY STORES CO · (0)114884006

ARGELIA
ALGER_NOVACASA · +213 21 55 07 37 +213 23 94 74 46
ORAN_PORCELANOSA ORAN · 14237002361

ARGENTINA
BUENOS AIRES_BLAISTEN S.A. · +54 11 463 620 00 +54 11 463 614 86
BUENOS AIRES_SHOWROOM PORCELANOSA VENIS · +54 11 4776 3008 +54 11 4776 3008
MAR DE PLATA_IMEPHO · +54 223 481 3827
MENDOZA_VICTOR GULLO · +54 261 431 4200

ARMENIA
YEREVAN_SACO & ARARAT-SALON BOMOND · +37 410 55 08 99 +37 410 50 05 50

ARUBA
ORNAJESTAAD_BANJOLUX · +297 588 0565

AUSTRALIA
ADELAIDE_ITALIA CERAMICS · +61 8 8336 2366
BRISBANE_EARP BROTHERS · +61 7 3088 8999
HOBART_ROSSETTO TILING · +61 3 6231 2931
LAUNCESTON_ROSSETTO TILING · +61 3 6326 4955
MELBOURNE_EARP BROTHERS · +61 3 9328 9588
NEWCASTLE_EARP BROS TILE - NEWCASTLE · +61 2 4962 5500
PERTH_CERAMO · +61 8 9445 1777
SYDNEY_EARP BROTHERS · +61 2 9410 3222

AUSTRIA
ANSFELDEN_BEINKOFER · +43 (0) 7229 78525 +43 (0) 7229 88818 - 50
BRUCK/MUR_TENNE BRUCK · +43 3862 588 44 +43 3862 588 44-22
GRAZ_FLIESEN TENNE · +43 316 262 524 0 +43 316 262 524 22
HALL_BEINKOFER BEI HOLTER · +43 (0) 5223 5046910 +43 (0) 5223 5046919
INSBRUCK_FLIESEN CENTER TIROL · +43 (0) 512 364444
LEIBNITZ_TENNE LIBNITZ KINDERMANN BAD & HEIZTECHNIK · +43 3452 707-65 +43 3452 707-29
LINZ_BEINKOFER · +43 732 776 543 0 +43 732 776 543 60
LINZ_BEINKOFER · +43 (0) 732 6552550 +43 (0) 732 65525520
SALZBURG_BEINKOFER BEI HOLTER · +43 (0) 662 469096920 +43 (0) 662 469094289
VÖSENDORF_TENNE VÖSENDORF · +43 1 699 33 33 +43 1 699 33 33-22
WELS_BEINKOFER BEI HOLTER · +43 (0) 7242 25253210 +43 (0) 7242 25253250
WIEN_BEINKOFER · +43 (0) 50 483-6940
WIEN_BEINKOFER BEI HOLTER · +43 (0) 1 61516006900 +43 (0) 1 61516006909
WIEN_BEINKOFER GMBH · +43 50 483 6950
WIEN_TENNE WIEN 22 BADKULT-NORT · +43 1 20 20 520 +43 1 20 20 520-20
WIEN_BEINKOFER BEI BÄDERPARADIES · +43 (0) 1 52242200 +43 (0) 1 522422020

AZERBAIYÁN
BAKU_AKSESUAR INSAAT · +994 12 546 74 86 +994 12 546 74 86

BAHAMAS
NASSAU_TILE KING - BUILDERS MALL · +1 242-601-8453

BAHRÁIN
MANAMA_AL ABBAS GALLERY · +973 741 919 +973 741 747

BARBADOS
BRIDGETOWN_KEYSTONE PRODUCTS · +1 246-418-8453

BANGLADESH
PORCELANOSA_DHAKA · +880 1793 567404

BÉLGICA
HEIST-OP-DEN-BERG_PGB CERAMICA NV · +32 (0)15 253366 +32 (0)15 253367

BERMUDAS
PEMBROKE_PEMBROKE TILE & STONE CO. LTD · +441 292 8453 +441 295 8453

BIELORRUSIA
MINSK_SAN REMO · +37 17 388 06 66

BOLIVIA
SANTA CRUZ DE LA SIERRA_TAGOMAGO · +591 776 748 25

BOSNIA-HERZEGOVINA
BIJELJINA_LUK D.O.O. · +387 55 228 100 +387 55 228 101
CITLUK_BROTIS D.O.O. · +387 36 650 960 +387 36 650 950
SARAJEVO_LUK D.O.O. · +387 33 777 888 +387 33 777 889

BRASIL
CURITIBA_PORCEBRAS · +55 (41) 3392 1500 +55 (41) 3392 1400

BULGARIA
BURGAS_ELE CERAMICA · +359 56 842 849
SOFIA_ELE CERAMICA · +359 28 606 060
VARNA_ELE CERAMICA · +359 52 500 555

CAMBOYA
PHNOM PENH_HOME LIVING · 855092434264

CAMERÚN
DOUALA_CONNECTIK HALL SAS · 237233434780

CANADÁ
MONTREAL_PORCELANOSA MONTREAL . P · (+1) 438.221.8705
VAUGHAN_PORCELANOSA EAST CANADA · P · (+1) 9.054.541.053 F · (+1) 905.454.1055
CALGARY_PORCELANOSA CALGARY · (587) 349-2290
TORONTO_PORCELANOSA TORONTO · 9054541053
VANCOUVER_FONTILE DISTRIBUTORS · +604 683 9358 +604 683 6758

PORCELANOSA Showrooms

CHILE
SANTIAGO_PORCELANOSA CHILE · (56 2) 434 92 87

CHINA
BEIJING_GUANGZHOU PO YICK DECORATION DESIGN CO LTD (BEIJING BRANCH) · +86 1085271313 +86 861064229976
CHANGCHUN_CHANGCHUN PORCELANOSA CERAMIC SHOWROOM · +86 43182787172 +86 43182775881
CHONGQUING_YAOSENG BUILDING MATERIAL BUSINESS DEPARTMENT NEW NORTH ZONE · +86 23 86358360 +86 23 86357182
DALIAN_DALIAN GREAT WORLD FURNITURE PLAZA LUBAO BLDG. MAT. BUSINESS DEP · +86 41182301911 +86 41182301911
FUZHOU_PO YICK CERAMIC SHOWROOM JINAN DISTRICT FUZHOU · +86 59188055823 +86 59188055823
GUANGZHOU_GUANGZHOU PO YICK DECORATION DESIGN CO LTD · +86 2022008228 +86 2022008228
GUANGZHOU_PO YICK DECORATION DESIGN CO LTD · +86 2087018223 +86 2087018226
HANGZHOU_DA DOU BUILDING MATERIAL BUSINESS · +86 13958149905
HEFEI_AN HUI JIA ZHUO BUILDING MATERIALS CO LTD · +86 55164842686
JIANGYIN_NANJING XINGLANG BUILDING MATERIAL CO LTD · +86 51081693999 +86 51081693999
JIAXING_JIA XING FEI FAN BUILDING MATERIALS CO LTD · +86 57382770662 +86 57382770662
JIN HUA_JIAJIAHONG BUILDING MATERIALS BUSINESS DEPARTMENT JIN DONG DISTRICT JIN HUA CITY NINGBO_NINGBO JING ZHOU NIN DONG TUO BI MATERIAL BUSINESS DEPARTMENT · +86 57487867539
QINGDAO_QINGDAO TOLI SPACE BUILDING MATERIALS CO LTD · +86 532 80995657 +86 532 80995657
SHANGHAI_GUANGZHOU PO YICK DECORATION DESIGN CO LTD (SHANGHAI BRANCH) SHANGHAI_PORCELANOSA SHANGHAI · +86 21 61397952
SHENYANG_SHENYANG PORCELANOSA CERAMIC SHOWROOM · +86 2431223766 +86 2485637137
SHENZHEN_SHENZHEN PORCELANOSA PO YICK BUILDING MATERIALS CO LTD · +86 75582407728
TAIYUAN_TAIYUAN PORCELANOSA CERAMIC SHOWROOM · +86 13701067286
TAIZHOU_TAI ZHOU SHI MING DIAN BUIDLING MATERIALS TRADING COMPANY LTD · +86 57689807883
TANGSHAN_TANG SHAN PORCELANOSA CERAMIC SHOWROOM · +86 3152732085
TIANJIN_TIANJIN OULINHUI BUILDING MATERIALS CO LTD · +86 22 23528765 +86 22 88277023
WUHAN_WUHAN HENG HUI BUILDING MATERIAL CO LTD · +86 2783995277 +86 2783995277
XIAN_PORCELANOSA BUILDING MATERIAL BUSINESS DEPARTMENT ETDZ XIAN · +86 2986122404

CHIPRE
GIRNE_MEPAS LTD · 9039 2815 2964 9039 2815 5651
LARNACA_CYKINGS CERAMICS · +357 9937 2121 +357 2481 8128
LIMASSOL_THE ENGINEERING AND COMMERCIAL ASSOCIATION (EKA) · +357 25854444 +357 25854545
NICOSIA_CH & P MAOURIS COMPANY LIMITED · +357 22444555 +357 22877835

COLOMBIA
BOGOTÁ_PORCELANOSA BOGOTÁ · +57 743 0209
MEDELLÍN_PORCELANOSA MEDELLÍN · +57(4) 322 5297

COREA DEL SUR
BUSAN_COTTO CERAMIC CO LTD · 82512080022 82512088558
SEO-GU_COTTO CERAMIC CO LTD · SEOUL_BARRO CERAMIC · 82234438600 82234438822

COSTA DE MARFIL
ABIDJAN_FADCO COMPANY · +225 21757355 +225 21757358

COSTA RICA
SAN JOSÉ_FERNANDEZ AGUILAR S.A. · +506 222 5674 +506 221 9952

CROACIA
ZAGREB_ABC INTERIJER · +385 16 393 164 +385 16 055 985
ZAGREB_SPINA · +385 13 492 552

DINAMARCA
GLOSTRUP_MOSAIKHJORNET · +45 43 633 900 +45 43 663 857
ODENSE M_DANESP FLISE KOMPAGNIET APS · +45 661 732 21 +45 661 738 21
AARHUS_DOKK16 A/S · +45 31 12 00 99

ECUADOR
CUENCA_GRIFINE HOME CENTER S.A · (593) 07 281-8089
GUAYAQUIL_GRIFINE HOME CENTER S.A · (593)4 370-2830
QUITO_GRIFINE HOME CENTER S.A · (593) 2 393-1920

EE.UU.
801 E EXPY 83_GILSA NORTH AMERICA · +1 956 223 2900
ANAHEIM_PORCELANOSA ANAHEIM · P · (+1) 714.772.3183 F · (+1) 714.772.9851
ATLANTA_PORCELANOSA ATLANTA · P · (+1) 404.973.0640 F · (+1) 404.973.0303
AUSTIN_PORCELANOSA AUSTIN · P · (+1) 214.931.9610
BOSTON_PORCELANOSA BOSTON - BOSTON DESIGN CENTER · P · (+1) 617.963.7666 F · (+1) 617.963.7675
BROOKLYN_PORCELANOSA BROOKLYN · P · (+1) 929.239.3260
CHESNUT HILL_PORCELANOSA CHESNUT HILL · P · (+1) 617.963.7666 F · (+1) 617.608.0175
CHICAGO_PORCELANOSA CHICAGO · P · (+1) 312.204.6220 F · (+1) 312.204.6240
CHICAGO_PORCELANOSA CHICAGO LINCOLN PARK · P · (+1) 872.245.0120
DALLAS_PORCELANOSA DALLAS EMERALD STREET · P · (+1) 469.310.2870
DALLAS_PORCELANOSA DALLAS HI LINE DRIVE · P · (+1) 214.377.2327 F · (+1) 214.234.1340
DENVER_PORCELANOSA DENVER · P · (+1) 303.802.3210 F · (+1) 303.802.3221
EAST BRUNSWICK_PORCELANOSA EAST BRUNSWICK · P · (+1) 732.613.1915 F · (+1) 732.613.9181
GLENDALE_GLENDALE TILE · P · (+1) 818.500.8505 F · (+1) 818.500.7130
HERMOSA BEACH_AMIRIAN HOME P · (+1) 424.390.4460 F · (+1) 424.390.4461
HOUSTON_PORCELANOSA HOUSTON · P · (+1) 281.605.2770 F · (+1) 281.605.2695
KING OF PRUSSIA_PORCELANOSA KING OF PRUSSIA · P · (+1) 484.751.0050 F · (+1) 484.751.0047
MIAMI_PORCELANOSA MIAMI · P · (+1) 305.715.7153 F · (+1) 305.592.6999
MIAMI_PORCELANOSA MIAMI DESIGN DISTRICT · P · (+1) 786.329.6753 F · (+1) 786.329.6760
NEW YORK CITY_PORCELANOSA MANHATTAN FLAGSHIP STORE · P · (+1) 646.751.1180
NORTH BETHESDA_PORCELANOSA MARYLAND NORTH BETHESDA · P · (+1) 240.290.1120
ROCKVILLE_PORCELANOSA MARYLAND ROCKVILLE · P · (+1) 301.294.8193 F · (+1) 301.294.8194
PARAMUS_PORCELANOSA PARAMUS · P · (+1) 201.712.0556 F · (+1) 201.712.0744
POMPANO BEACH_PORCELANOSA POMPANO BEACH · P · (+1) 954.968.7666 F · (+1) 954.968.7699
RAMSEY_PORCELANOSA RAMSEY · P · (+1) 201.995.1310 F · (+1) 866.841.5185
RIVERSIDE_PORCELANOSA RIVERSIDE · P · (+1) 786.329.6768 F · (+1) 203.698.7619
SAN DIEGO_PORCELANOSA SAN DIEGO · P · (+1) 858.322.6012 F · (+1) 858.348.0015
SAN FRANCISCO_PORCELANOSA SAN FRANCISCO · P · (+1) 415.593.7763 F · (+1) 415.593.7664
SAN JOSÉ_PORCELANOSA SAN JOSE · P · (+1) 408.467.9400 F · (+1) 408.467.9410
SEATTLE_PORCELANOSA SEATTLE · P · (+1) 206.673.8395 F · (+1) 206.673.8402
WALNUT CREEK_PORCELANOSOA WALNUT CREEK · P · (+1) 925.952.7430 F · (+1) 925.300.9026
WASHINGTON DC_PORCELANOSA WASHINGTON DC · P · (+1) 022.041.655
WEST HOLLYWOOD_PORCELANOSA WEST HOLLYWOOD · P · (+1) 310.300.2090 F · (+1) 310.300.2095
WESTBURY_PORCELANOSA WESTBURY · P · (+1) 516.338.0097 F · (+1) 516.338.0098

EGIPTO
EL CAIRO_MAHGOUB TRADING & IMPORTING · +20 2 57 12 565 +20 2 57 39 344

EL SALVADOR
SAN SALVADOR_FERRETERÍA DE LA CONSTRUCCIÓN · FERCO · (503) 2510 8888 (503) 2510 8810

EMIRATOS ÁRABES
DUBAI_PORCELANOSA ASSOCIATE DUBAI · (+ 971) 43 35 38 88
DUBAI_PORCELANOSA DUBAI · (+971) 43 35 38

ESLOVAQUIA
BRATISLAVA_CERSA · 421244442833
KOSICE_VODOARM · (055) 6222660 (055) 6222654
NOVE ZAMKY_M LUXURY SRO · 42135607790
KOSICE_ELKEM SRO KOSICE · 421557281615, 421557281617
TOPOLCANY_REHAK SRO · 4219115454957

ESLOVENIA
LIUBLJANA_ŠMARTINSKA CESTA 52, ABC INTERIJER DOO (SI) · 38670579223

ESTONIA
TALLINN_PLAADIPUNKT · +372 650 0720 +372 650 0723

ETIOPÍA
ADDIS ABABA_J SALE TRADING · +251 (0)911 20 53 91 +251 (0)930 03 45 51

FEDERACIÓN RUSA
EKATERIMBURGO_SALON BOMOND · +7 (922) 135 35 92
EKATERINBURG_BOMOND · +7 (343) 287 55 79
GROZNY_BOMOND · +7 (8712) 22 45 28
KAZAN_ARTDECORIUM · +8 917 917 23 22
KHABAROVSK_DOM APEX · (4232) 30 06 88
KHIMKI_ZODIAC · +7 (495) 730 97 97
KRASNODAR_BOMOND · +7 (861) 210 26 83
KRASNODAR_SALON BOMOND · +7 (862) 234 10 75
KRASNOYARSK_ELITSTROY · +7 (391) 206 99 99
MAKHACHKALA_T. D. MODERN · +7 (8722) 676 569
MOSCOW_ART

PORCELANOSA Showrooms

INTERNACIONAL | INTERNATIONAL

FRANCIA
SAINT-ETIENNE_PORCELANOSA ASSOCIATE · 04 77 30 56 76
SAINT-QUAY-PERROS - CARRELAGES & STYLES · +33 (0)296136800
SAINT-PAUL-LÉS-DAX - CAREL · +33 (0)558919947
SAINT-PÉRAY_PORCELANOSA ASSOCIATE· +33 (0)4 75 60 53 51 +33 04 75 80 22 40
VARENNES LÉS MÂCON_HENRI DE ALMEIDA CREATIONS · +33 03 85 36 33 15 +33 03 85 30 53 64
VEDÈNE_PORCELANOSA AVIGNON · 04 90 02 64 02
ANNECY_PORCELANOSA ANNECY · +33(0)4 38 80 09 90
ARCEUIL_PORCELANOSA PORTE D'ORLÉANS · +33 (0)149 121 257 +33 (0)149 121 258
AUBAGNE_PORCELANOSA MARSEILLE · +33 (0)442 624 330 +33 (0)442 624 339
BEAUCOUZÉ_PORCELANOSA ANGERS · +33 (0)241 738 100 +33 (0)241 733 721
BESANÇON_PORCELANOSA BESANÇON · +33 (0)381 416 363 +33 (0)381 416 369
BREST_PORCELANOSA BREST · +33 (0)298 025 100 +33 (0)298 415 401
CHAMBRAY LES TOURS_PORCELANOSA TOURS · +33 (0)247 808 787 +33 (0)247 808 789
CHAMPAGNE-AU-MONT-D'OR_PORCELANOSA LYON · +33 (0)478 668 151 +33 (0)478 432 003
CHASSENEUIL DU POITOU_PORCELANOSA POITIERS · +33 (0)549 119 787 +33 (0)549 119 788
CHENÔVE_PORCELANOSA DIJON · +33 (0)380 588 701 +33 (0)380 588 595
COIGNIÈRES_PORCELANOSA COIGNIÈRES · +33 (0)130 491280 +33 (0)130 491328
GUÉRANDÉ_PORCELANOSA LA BAULE · +33 (0)240 607 273 +33 (0)240 110 659
LA CHAPELLE SAINT AUBIN_PORCELANOSA LE MANS · +33 (0)243 236 520 +33 (0)243 240 512
LA ROCHE SUR YON_PORCELANOSA LA ROCHE-SUR-YON · +33 (0)251 241 217 +33 (0)251 242 399
LEZENNES_PORCELANOSA LILLE · +33 (0)320 340 340 +33 (0)320 340 341
LORIENT_PORCELANOSA LORIENT · +33 (0)297 875 000 +33 (0)297 370 607
LYON – PORCELANOSA LYON CENTRE +33(0)4 37 42 05 00
MANDELIEU LA NAPOULE_PORCELANOSA CANNES · +33 (0)493 477 360 +33 (0)493 477 402
MEAUX_PORCELANOSA MEAUX · +33 (0)160 092828 +33 (0)160 093131
MERIGNAC_PORCELANOSA BORDEAUX · +33 (0)556 124 848 +33 (0)556 124 849
MONDEVILLE_PORCELANOSA CAEN · +33 (0)231 820 000 +33 (0)231 820 019
MONTIGNY-LÈS-CORMEILLES_PORCELANOSA MONTIGNY · +33 (0)1 39 31 19 79 +33 (0)1 39 31 14 92
NÎMES_PORCELANOSA NÎMES · +33 (0)466 282 780 +33 (0)466 282 781
ORVAULT_PORCELANOSA NANTES · +33 (0)228 073 950 +33 (0)228 073 957
PARIS_PORCELANOSA PARIS 7ÈME · 01 42 84 84 00 01 42 84 84 01
PÉROLS_PORCELANOSA MONTPELLIER · +33 (0)467 503 600 +33 (0)467 501 121
SAINT GRÉGOIRE - RENNES_PORCELANOSA RENNES · +33 (0)223 200 808 +33 (0)299 369 688
TOULOUSE_PORCELANOSA TOULOUSE · 05 34 56 57 60 05 34 56 57 86
TOURVILLE LA RIVIÈRE_PORCELANOSA ROUEN · +33 (0)235 650 655 +33 (0)235 650 656
VANNES_PORCELANOSA VANNES · +33 (0)297 460 292 +33 (0)297 461 210
VENDENHEIM_PORCELANOSA STRASBOURG · +33 03 88 20 82 90 +33 (0)388 209 107
VERT SAINT DENIS_PORCELANOSA MELUN · +33 (0)160 565 747 +33 (0)160 569 080
CHAMPAGNE-AU-MONT-D'OR_DÉPÔT LYON · 04 78 66 81 56
SAINT HERBLAIN_DÉPÔT SAINT-HERBLAIN · +33 2 40 16 94 00 +33 2 40 16 94 14
TIGERY_DÉPÔT PARIS IDF · 01 69 90 49 00

GEORGIA
TBILISI_LUXOR SHOP · +995 32 2388898 +995 32 2388399

GHANA
ACCRA_CASA TRASACCO · +233 30 282 3322

GRECIA
ATTICA_SUERO · +30 2105 594 520 +30 2105 594 521
GLIFADA_HATZ GROUP · +30 2310 752 902 +30 2310 753 564
THESSALONIKI_PORCELANA · 2310 700 861 2310 700 861
THESSALONIKI_PORCELANA · 2310 753 003 2310 753 003
THESSALONIKI_PORCELANA · 2310 474 767 2310 474 403

GUADALUPE
BAIE MAHAULT_GUADELOUPE CERAMIQUE · +590 266 261 +590 266 412
SAINT BARTHELEMY_ALMA QUINCAILLERIE · +590 276 494 +590 276 738

GUATEMALA
CIUDAD DE GUATEMALA_FERRETERÍA DE LA CONSTRUCCIÓN FERCO · (+502) 2421 9000 (+502) 2421 9009

HAÏTÍ
PORT AU PRINCE_EUROCERAM · 0 999 999 984

HONG KONG
KOWLOON_TAI YICK BUILDING MATERIALS · +852 23 956 670 +852 23 957 831

HUNGRÍA
BÉKÉSCSABA_PALATINUS FURDOSZOBASZALONOK · +36 66 328 432 +36 66 328 432
BUDAPEST_AXOR HOME KFT · +36 1 2370878 +36 1 2370879
BUDAPEST_MIRAGE 86 ZRT · +36 1 793 9532 +36 1 799 6289
BUDAPEST_PALATINUS FURDOSZOBASZALONOK · +36 1 430 04 17 +36 1 387 91 36
DREBECEN_PALATINUS FURDOSZOBASZALONOK · +36 3 031 94 353 +36 52 536 822
EGER_PALATINUS FÜRDÓSZOBASZALON EGER · +36 3681 4319 +36 3631 0575
EGER_PALATINUS FURDOSZOBASZALONOK · +36 0636 312 013 +36 0636 313 270
ÉRD M7-ES FELJÁRÓ_VS FÜRDÓSZOBA ÉRD · +36 304 831 154
GYÖNGYÖS_PALATINUS FURDOSZOBASZALONOK · +36 37 500 162 +36 37 500 163
KECSKEMÉT_PALATINUS FÜRDÓSZOBASZALON KECSKEMÉT · +367607918
MAGYAR_VS RBC - RAVAK BUSINESS CENTER · +36 304831154
MISKOLC_PALATINUS FURDOSZOBASZALONOK · +36 46 412 741 +36 46 416 256
NYÍREGYHÁZA_KOVÁCS TÜZÉP CT · VIDA ERZSÉBETCCC · +36 42 598 073
TARJÁN_STRAUBINGER ÉPÍTÉSI VÁLLALKOZÓ KFT · +36 303 483 773

INDIA
NEW DELHI_MARMO HOME PVT. LTD. · +91 11 47128800 +91 11 23218728

INDONESIA
BANDUNG_WISMA SEHATI (BANDUNG) · +62 22 723 8515 +62 22 723 8516
JAKARTA_WISMA SEHATI (BSD) · +62 21 537 7278 +62 21 537 7880
JAKARTA_WISMA SEHATI (MANGGA DUA) · +62 21 6013303 +62 21 6251221
JAKARTA_WISMA SEHATI (POLIM) · +62 21 72787711
SEMARANG_WISMA SEHATI (SEMARANG) · +62 24 356 2233 +62 24 356 2222
SURABAYA_WISMA SEHATI · +62 31 5631999

IRÁN
TEHRAN_FARBAR COMPANY · +982188036364

IRAQ
BAGHDAD_BAGHDAD TIME COMPANY LTD · +964 771 111 1594 +964 771 186 2730
ERBIL_AKSESUAR INSAAT ERBIL · +964 750 835 0055 +964 66 210 1900

IRLANDA
CORK_O.B. HEATING, PLUMBING, BATHROOMS & TILES · +353 0 214 310 000 +353 0 214 310 003
DUBLIN_TILESTYLE LTD · +00 353 1 8555200 +00 353 1 8557471
RATHNEW_MILLER BROS STONE DEVELOPMENT · +353 0404 32222

ISLANDIA
REYKJAVIK_ALFABORG EHF · +354 568 6755 +354 568 1277

ISLAS CAÍMAN
CAIMAN_STAFFORD FLOORING · +1 345-943-2722

ISRAEL
BNEY BRAK_HEZI BANK · +972 3 616 6641 +972 4 904 6643
HAIFA_TOPOLSKI & CO LTD · +972 4 904 0496 +972 4 904 0455
JERUSALEM_BAR-AMI 1990 LTD · +972 2 531 3444 +972 2 538 3740
KANOT_POLINOY · +972 5 277 73437
RAANANA_AMOZI NAGAR IMPMARK.OGEN LTD · +972 9 760 1501 +972 9 741 1997
RISHON LE ZION_NEGEV CERAMICS · +972 3 9436830 +972 3 9436810
ROSH HAIIN_BACERAMIC DESIGN · +972 3 603 0111 +972 3 907 1992
UPPER GALILY_KAMARIKA · +972 4 680 1010 +972 4 680 0318

ITALIA
ANDRIA_MIDIL-CERAMICHE S.A.S · +39 08 835 66466 +39 08 835 49260
BELLUNO_PORCELANOSA BELLUNO · +39 32 890 78586 +39 04 379 25482
BERGAMO_PORCELANOSA BERGAMO · +39 03 529 9984 +39 03 529 22085
CORSICO_PORCELANOSA LOMBARDIA · +39 02 458 64310 +39 02 458 64415
ELMAS_PORCELANOSA CAGLIARI · +39 70 211 0009 +39 70 212 8144
MILANO_SPAZIO LIBIA 3 · +39 02 872 46767
MONTESILVANO_PORCELANOSA PESCARA · +39 08 544 93241 +39 08 544 56002
ROMA_PORCELANOSA ROMA · +39 06 888 9977 +39 06 888 7056
SASSUOLO_PORCELANOSA SPA · +39 05 368 06677 +39 05 368 02184
TREVISO_PORCELANOSA TREVISO · +39 04 226 97087 +39 04 223 01767

JAMAICA
KINGSTON_TILE CITY & HOME CENTRE · +1 876 925 8453

JAPÓN
TOKYO_YOSHIMOTO TRADING CO. LTD · +072 334341700

JERSEY
ST. SAVIOUR_PASTELLA GROUP · 01534 870167 01534 723199

JORDANIA
AMMAN_AYMAN ABDALLAT & PARTNERS CO. · 9002 956197 5504523

KAZAJISTÁN
ALAMTY_ALTAIR · +7 (727) 393 56 17
ALAMTY_DOMINA · +7 (727) 275 50 36
ALMATY_PALATIN · +7 (727) 395 78 78 +7 (727) 351 98 98
ALMATY_PALATIN · +7 (727) 351 98 98
ASTANA_ALTAIR · +7 (7172) 92 82 82
ASTANA_DOMINA · +7 (7172) 76 97 61
ASTANA_PALATIN · +7 (7172) 92 82 82
ASTANA_PORCELANOSA ASTANA · +7 (7172) 28 83 37

KENIA
NAIROBI_LIFESTYLE INTERIORS LTD · 254713380549

KOSOVO
PRISHTINË_N P KERASAN · +381 38 602 667 +381 38 602 667

KUWAIT
SAFAT_HASSAN ABUL HASSAN SADIQ · +965 262 4466 +965 265 1444

LETONIA
RIGA_TORMANIS UN PARTNERI · +371 784 5361 +371 784 5360

LÍBANO
BEIRUT_GEAHCHAN GROUP · +961 1 480520 +961 1 496607
BEIRUT_PORCELANOSA GROUP BEIRUT · +961 18811170

LIBIA
BENGHAZI_EL RAGUOBI · 218 61 4704533 218 61 2237328
BERKA BENHAZI_MANART AL ANDALOS EST · 21861229605 218612237328
TRIPOLI_EL RAGUOBI · 218 91 3274885

LITUANIA
VILNIUS_INTERJO SALA - JSC VENDE · 370 6 8711071
VILNIUS_OGRINDA UAB · 370 5 2607854
VILNIUS_OGRINDA UAB · 370 5 2715519

MACEDONIA
SKOPJE_TE LINDI DOO · +389 2 2 602 628 +389 2 2 602 638
SKOPJE_PORCELANO-AMBIENT DOOEL · +389 70387776

PORCELANOSA Showrooms

INTERNACIONAL | INTERNATIONAL

MALASIA
ALOR SETAR_APEX BOUTIQUE - SELANGOR · + 603 7875 7833
KOLOBONG,KOTA KINABALLU_APEX BOUTIQUE – KOTA KINABALLU · +6088 388 150 +6088 389 150
KUALA LUMPUR_APEX BOUTIQUE - KUALA LUMPUR · +603 4043 8333 +603 4044 3338
PENANG_APEX BOUTIQUE – PENANG · +604 659 3322 +604 659 3339
PETALING JAYA_APEX BOUTIQUE - SELANGOR · + 603 7875 7833 +603 7876 7833
PETALING JAYA_PORCELANOSA KUALA LUMPUR · +603 7865 8817 +603 7865 7730
SEBERANG PRAI TENGAH_APEX BOUTIQUE - BUTTERWORTH · +604 3988 333 +604 3988 987

MALTA
BIRKIRKARA_ROGER SATARIANO & SONS LTD · +356 21 442 769 +356 21 497 017

MARRUECOS
CASABLANCA_CERAMEX · +212 945 3646166 +212 5223 395363
CASABLANCA_SANITAIRE 2000 · +212 22 363 225 +212 22 394 100
TANGER_FACENOR S.A. · +212 39 941 910 +212 39 945 445

MARTINICA
LAMENTIN_JOSEPH COTTRELL S.A. · +596 509 810 +596 506 524

MÉXICO
CANCÚN_PORCELANOSA CANCÚN · (998) 313 2343 (55) 58317340 EXT. 107
CIUDAD DE MÉXICO - ALTAVISTA_PORCELANOSA MÉXICO - ALTAVISTA · (55) 5550 7060 (55) 5550 7060
CIUDAD DE MÉXICO - INTERLOMAS_PORCELANOSA MÉXICO - INTERLOMAS · +(55) 3605 0064
CIUDAD DE MÉXICO - MASARYK_PORCELANOSA MÉXICO - MASARYK · (55) 528220 00 (55) 5282 2737
CIUDAD DE MÉXICO - VALLE DORADO_PORCELANOSA MÉXICO - VALLE DORADO · (55) 5831 7340
GUADALAJARA_PORCELANOSA GUADALAJARA · (33) 3615 3255
PLAYA DEL CARMEN_PORCELANOSA PLAYA DEL CARMEN · (984) 873 1090 (55) 58317340 EXT. 107

MÓNACO
MONACO_PORCELANOSA MONACO · +377 93 50 23 87

MONGOLIA
ULAAANBAATAR_ZUUNNAIMAN SUVRAGA COLTD · +976 (11) 3414 217

MONTENEGRO
PODGORICA_ENTEXT · 38220260833

MYANMAR
YANGON_PORCELANOSA ASSOCIATE MYANMAR · (+95) 9956988932

NEPAL
KATMANDU_RUKMANI INTERNATIONAL PVT LTD · 97714420281 97714428295

NICARAGUA
MANAGUA_DECO CENTER - GRUPO IBERICA NICARAGUA · +505 270 2121 +505 277 0834

NIGERIA
VICTORIA ISLAND, LAGOS_PORCELANOSA LAGOS · +234 8090371913

NORUEGA
ÅLESUND_FAGFLIS ÅLESUND · +47 70 10 22 64
BODØ_FAGFLIS BODØ · +47 75 52 25 57
BÆRUM_FAGFLIS BÆRUM · +47 67 10 34 90
BERGEN_FAGFLIS BERGEN · +47 55 11 77 40
DRØBAK_FAGFLIS DRØBAK · +47 64 93 96 76
ELVERUM_FAGFLIS ELVERUM · +47 62 41 67 60
FREDRIKSTAD_FAGFLIS FREDRIKSTAD · +47 69 31 70 00
GJØVIK_FAGFLIS GJØVIK · +47 61 18 80 86
GURSKØY_FAGFLIS SØRE SUNNMØRE · +47 70 10 22 77
HAMAR_FAGFLIS HAMAR · +47 62 59 70 00
KLØFTA_FAGFLIS KLØFTA · +47 63 98 29 20
KRISTIANSUND_N_FAGFLIS KRISTIANSUND · +47 70 10 22 76
LARVIK_FAGFLIS LARVIK · +47969 15 027
LIERSKOGEN_FAGFLIS LIERTOPPEN · +47 31 00 02 80
MOLDE_FAGFLIS MOLDE · +47 70 10 22 74
MOSS_FAGFLIS MOSS · +47 69 24 15 70
NARVIK - ANKENESSTRAND_FAGFLIS NARVIK · +47 76 95 04 90
NESTTUN_FAGFLIS BERGEN · +47 55 11 77 40 +47 55 11 77 49
OPPDAL_FAGFLIS OPPDAL · +47 72 42 23 50
OSLO_FAGFLIS ARKITEKTSHOWROOM · +47 22 80 85 60
OSLO_FAGFLIS OSLO · +47 22 80 18 00 +47 22 80 18 01
SANDEFJORD_FAGFLIS SANDEFJORD · +47 69 24 62 00
SANDNES_FAGFLIS SANDNES · +47 51 63 15 36
SKIEN_FAGFLIS GRENLAND · +47 35 58 70 00
TØNSBERG_FAGFLIS TØNSBERG · +47 33 35 81 60

NUEVA ZELANDA
CHRISTCHURCH_NEXT DORE · 03 366 9400 03 365 4406

PAÍSES BAJOS
AMSTERDAM_PORCELANOSA ARCHITECTEN SHOWROOM, PGN CERAMICA B.V. · 0031 20 7372845

PAKISTÁN
LAHORE_4 WALLS (PRIVATE) LIMITED · +92 42 111 492 557

PALESTINA
BETHLEHEM (WEST BANK)_AL-KHAYAL (BAYTOUNA) · +972 2 277 7279 +972 2 274 4026

PANAMÁ
OBARRIO, CIUDAD DE PANAMÁ_EUROCER S.A. · +507 21 53660

PARAGUAY
ASUNCIÓN_IPALE ALTA GAMA · +595 21 613 544

PERÚ
LIMA_CASSINELLI · +51 14 513 712 +51 15 612 757
SAN ISIDRO_PORCELANOSA GRUPO PERÚ · +51 1441 41 06

POLONIA
BIALYSTOK_AKCESS · +48 85 6643436 +48 85 6643434
BIELSKO-BIALA - ADARI - 338220449
BYDGOSZCZ_SALON MO (BYDGOSZCZ) · +48 52 348 9343 +48 52 348 9354
CZESTOCHOWA_P.H.U. FUGA · +48 34 368 2944 +48 343682944
GLIWICE_ART CERAMIKA · +48 32 339 8200 +48 32 339 8209
GORZÓW WLKP_SALON MO (STUDIO DEKOR) · +48 95 721 4108 +48 95 721 41
GLIWICE - ADARI - 322322155
GORZOW - STEMAR - 0957 204 555
KALISZ_SALON MO (SPECTROOM) · +48 62 502 10 15
KATOWICE - ADARI - 322589574
KATOWICE_MAX FLIZ · +48 32 720 92 00 +48 32 720 92 00
KRAKOW - MAX FLIZ - 0122 907 12
KIELCE_EXCLUSIVE · +48 41 345 75 49
KOŁOBRZEG_SALON MO (KOŁOBRZEG) · +48 94 355 18 88 +48 94 355 18 80
KONIN_SALON MO (KONIN) · +48 63 243 31 14
KRAKÓW_MAX FLIZ · +48 01 229 07060 +48 01 229 07060
LESZNO_SALON MO (LESZNO) · +48 65 529 63 63
LODZ_FUMINO · +48 42 637 37 67
LODZ - GRES - 48 42 636-20-38 / 48 601-355-419
ŁÓDŹ_CERMAG SP ZOO · +48 77 457 35 09/10 +48 77 474 88 82
LUBLIN_SALONIKA · +48 81 740 99 30
LUBLIN - ANDBUD - 081 469 9617
OPOLE_CERMAG SP ZOO (OPOLE) · +48 42 616 55 44 +48 42 611 61 61
OSTRÓW WLKP_SALON MO (OSTRÓW WLKP) · +48 62 735 81 12 +48 62 737 28 91
POZNAN_SALON MO (POZNAN) · +48 61 835 97 50 54
POZNAN - STEMAR POZNAN - 616425802
RABKA - CERAMPOL - 48185065600
RZESZÓW_F.H. BOZ S.A. · +48 17 850 0315 +48 17 850 0341
RZESZÓW_CERMAG STREFA ARCHITEKTA (RZESZOW)
RZESZÓW - ANDBUD - 017 785 1020
TYCHY - ADARI - 0322 322 155
SLUPSK_SLUPSK - GRESMAX · +48 59 843 4153 +48 59 843 4153
SOPOT_SALON MO (SOPOT) · +48 58 550 4235
SZCZECIN_CERMAG STREFA ARCHITEKTA (SZCZECIN) · +48 91 434 00 48 +48 91 434 07 35
VARSOVIA_INTERNITY · +48 22 639 84 94
WARSAWA - GALERIA VENIS - 0226 730 371
WROCLAW_CERMAG SP ZOO (WROCLAW) · +48 717 820 021 +48 717 820 031

PUERTO RICO
GUAYNABO_THE TILE SHOP · +1 787 720 2030 +1 787 790 2030
SAN JUAN_THE TILE SHOP · +1 787 775 2030 +1 787 707 0138

QATAR
QATAR_UNITED SUPPLIES · +974 46 85 164 +974 46 85 165

REINO UNIDO
11-17 NUFFIELD TRADE ESTATE_BATHROOM ELEGANCE · 01202 675 992 01202 675993
BALLYCASTLE_BALLYCASTLE HOMECARE · 028 2076 3302 028 2076 2418
BALLYMENA_J & R KEYS · 028 2564 2971
BEDFORD_MARABESE CERAMICS - BEDFORD · 01234 324594 01234 266446
BELFAST_BEGGS & PARTNERS · 028 9023 5791 028 9023 3273
BRIDGE ROAD_CERAMIC TILE WAREHOUSE · 01276 678 845
BRISTOL_PORCELANOSA WESTERN · 0117 959 71 51 0117 959 71 55
CANNOCK_PORCELANOSA MIDLANDS · 01543 223025 01543 462959
CARDIFF_PORCELANOSA WESTERN · 0292 0465 166 0292 0465 156
CROYDON_PORCELANOSA SOUTH EAST · 02086 670 994 08444 818 963
CUMBRIA_ALEXANDER & SANCTO · 01539 725255 1792700900
DONCASTER_PORCELANOSA YORKSHIRE · 01302 30 47 13 01302 30 47 15
DORCHESTER_BATHROOM INSPIRATIONS · 01305259966 01305259994
EDINBURGH_PORCELANOSA SCOTLAND · 0131 335 38 83 0131 335 38 84
EWELL_INTER TILES & INTERIORS · 0208 3942928
EXETER_PORCELANOSA WESTERN · 01392 215 552 01392 215 557
FULHAM_PORCELANOSA SOUTH EAST · 0207 751 2150 08444 818 962
GLASGOW_PORCELANOSA SCOTLAND · 0141 533 1000 0141 533 1007
HEMEL HEMPSTEAD_EBBERNS · 01442 253878 01442 768481
IPSWICH_FOXWOOD CERAMICS · 01473 622 310

PORCELANOSA Showrooms

INTERNACIONAL | INTERNATIONAL

REPÚBLICA CHECA

BRNO_DESIGN BATH SE · +420 547 216 621
LIBEREC_DORINT GROUP, A.S. · +420 602457510
PRAHA_DESIGN BATH SE · +420 222 984 951
PRAHA_DORINT PHA S.R.O. · +420 271 745 269

REPÚBLICA DEMOCRÁTICA DEL CONGO

KINSHASA_SOCIETE PANACHE · +243 884 1677 +243 983 13893

REPÚBLICA DOMINICANA

BÁVARO_CARABELA S.R.L. · +1 809 466 0020 +1 809 466 2006
LA ROMANA_CARABELA S.R.L. · +1 809 556 3606 / 809 550 9006 +1 809 221 7416
SANTIAGO_CARABELA S.R.L. PORCELANOSA · +1 809 971 1234 +1 809 971 6728
SANTO DOMINGO_CARABELA S.R.L. · +1 809 544 2560 +1 809 541 0818

REUNIÓN

SAINT DENIS_RAVATE PROFESSIONNEL SAS · +262 904 024 +262 904 057

RUMANÍA

BRASOV_DELTA STUDIO BRASOV · +40 (723) 101.430
BUCAREST_GLAMOUR · 40311000586
BUCAREST_GLAMOUR · 0040 31 229 3210
BUCAREST_DELTA STUDIO SRL · 0374 659 007
CLUJ-NAPOCA_STUDIO CLUJ-NAPOCA 0364880060
CONSTANTA_DELTA STUDIO CONSTANTA · 0722 240 736
CRAIOVA_SC MYDWAY IMPEX SRL · +40 722 285 029 +40 251 427 946
IASI_DELTA STUDIO IASI · 0730 586 938
ORADEA_MAIISON DESIGN · +40 743 507 811 +40 259 410 170
PITESTI_DELTA STUDIO PITESTI · 0723 363 823
PLOIESTI_DELTA STUDIO PLOIESTI · 0723 541 737
SIBIU_DELUXE STUDIO · +40 743 213 263
TIMISOARA_DELTA STUDIO TIMISOARA · 0374659015

SENEGAL

DAKAR_C.C.S. · +221 33 849 04 04 +221 33 823 13 10

SERBIA

BELGRADO_HOME CONCEPT · +381 11 6558 960
BELGRADO_PORCELANOSA HOME CONCEPT · +381 11 6557 087

SINGAPUR

SINGAPUR_FERNANDO MARTIN BENITO · +65 97801472 +65 64621620

SRI LANKA

COLOMBO 13_RANJANAS CERAMIC · +94 11 2543255 +94 11 2381386

SUDÁFRICA

CAPE TOWN_CLASSIC TRADING · 021 465 9277 021 462 0973
DURBAN_CLASSIC TRADING · +27 31 579 1900 +27 31 577 7056
JOHANNESBURG_CLASSIC TRADING · +27 11 656 0400 +27 11 656 0403

SUECIA

BROMMA_KAKELPALATZET I BROMA AB · +46 (0)8 56 487 831
GÖTEBORG_KAKELPALATZET I BÄCKEBOL AB · +46 (0)31 571 478
KATRINEHOLM_KAKELPALATZET I KATRINEHOLM AB · +46 (0)8150-51 740
MÖLNDAL - KAKELPALATZET I MÖLNDAL HEADQUARTERS · +46 (0)31 776 50 51

SUIZA

AUBONNE_ARGECOM SA · +41(0)21 807 10 10 +41(0)21 808 61 02
ARBON_HAMA KERAMIKDESIGN · +41 71 446 61 66 +41 71 446 61 65
BIEL_SABAG SA · +41 32 328 28 28 +41 32 328 28 80
CRISSIER_SABAG SA · +41 21 633 06 84 +41 21 633 06 85
GENEVE_SABAG SA · +41 22 908 06 90 +41 22 908 06 95
LUGANO-GRANCIA_PL VALLI SA · +41 919 859 510
MENDRISIO_NEW FORM SWISS SAGL · +41 919 227 356
ROTHENBURG_SABAG SA · +41 41 289 72 72 +41 41 289 72 73
SEVELEN_KAISER AG BAD & PLÄTTLI · +41 81 785 2242 +41 81 785 2204
SUIZA_1219 MAGENTA HOME DESIGN · +41 848 308 308
VOLKETSWIL_MPV HANDELS AG · +41 (0)43 399 53 00 +41 (0)43 399 53 20
YVERDON-LES-BAINS_SABAG SA · +41 24 423 44 30 +41 24 423 44 45
YVERDON LES BAINS_SABAG YVERDONS · +41 24 423 4444

SURINAM

PARAMARIBO_JAP HOUSING · +597 817-0064

TAILANDIA

BANGKOK_BOONTHAVORN CERAMIC (RATCHADAPISEK) · +66 2275-0029 +66 2275-2057
BANGKOK_BOONTHAVORN CERAMIC CO. LTD. (PIN-KLAO) · +66 2441-3075 +66 2441-4049
BANGKOK_BOONTHAVORN CERAMIC CO. LTD. (KASET NAVAMIN) · +66 2791-2777 +66 2943-9058
BANGKOK_BOONTHAVORN CERAMIC CO. LTD. (SUVARNNABHUMI) · +66 2316-0429 +66 2750 0682
BANGKOK_BOONTHAVORN CERAMIC CO. LTD. (PATTAYA) · +66 38 052 222 +66 38 052 221
CHIANGMAI_BOONTHAVORN CERAMIC CO. LTD. (CHIANGMAI) · +66 5310-5099 +66 5310-5107
MUEANG SURAT THANI DISTRICT_BOONTHAVORN CERAMIC - SURAT THANI · +66 77 237 000
PATHUMTHANEE_BOONTHAVORN CERAMIC CO. LTD. (RANGSIT) · +66 2902-0171 +66 2902-0184
PRACHUABKIRIKUN_BOONTHAVORN CERAMIC CO. LTD. (HUAHIN) · +66 3252 2555 +66 5488-4144
+66 3252-0141 SAMUTSAKHON_BOONTHAVORN CERAMIC - SAMUTSAKHON · +66 2 896 44712 +66 2 896 4473
UDON THANI_BOONTHAVORN CERAMIC - UDON THANI · +66 42 215 678

TAIWAN

KAOHSIUNG_NEW CENTURY CONSTRUCTIONAL · +886 7 384 8834
TAICHUNG_NEW CENTURY CONSTRUCTIONAL · +886 4 2372 8166
TAINAN_NEW CENTURY CONSTRUCTIONAL · +886 6 2613290
TAIPEI_NEW CENTURY CONSTRUCTIONAL · +886 2 33933123

TANZANIA

DAR ES SALAAM_ABC EMPORIO TANZANIA · +255 719885566

TÚNEZ

GABES_ABC ABDENNADHER · 75 29 49 10 74 24 48 85
HAMMAM SOUSSE_ABC ABDENNADHER · 73 32 44 24 73 32 44 25
HAMMAMET_ABC ABDENNADHER · 72 26 04 77 72 26 04 77
MENZEL HAYET_ABC ABDENNADHER · 73 41 04 16 73 41 04 01
SFAX_ABC ABDENNADHER · 74 46 80 72 74 24 48 85
SOUSSE_ABC ABDENNADHER · 73 37 14 76 73 37 14 75
TUNIS_ABC ABDENNADHER · 71 72 58 80 71 72 57 77 71 76 00 46
TUNIS_LIFE STYLE · +216 71 861 551 +216 71 861 549
TUNIS CEDEX_ABDENNADHER BRICOLAGE CENTER · +216 71 725 194 +216 71 760 046

TURQUÍA

ISTAMBUL_YÜTAS · +90 2 1227 44720 +90 2 1227 20874

UCRANIA

DNIPROPETROVSK_EUROPA DNIPRO · (0562) 31 27 53
KHARKIV_EUROPA · +380 577 714 509
KHMELNYTSKYI_SOPRANO · +380 673 543 447
KYIV_SALON MILLENNIUM CONCEPT · (044) 279 60 60
LVIV_KERAMA MARKET · +380 322 972 500
LVIV_SALON KARMEN · +380 32 244 40 55 +380 32 252 70 94
MYKOLAIV_YALOT · +380 512 500 284
POLTAVA_DOGODA · +380 532 687 575
TERNOPIIL_VERO · 098 67 67 112
VINNYTSIA_LANA · +380 432 507 838

UGANDA

KAMPALA_ABC STILES & BATHZ · +256 776022333

URUGUAY

MONTEVIDEO_ACHER · +598 2 487 5630
PUNTA DEL ESTE_ACHER · +598 4 224 8343 +598 42 250869

UZBEKISTÁN

TASHKENT_PREMIUM CONCEPT · +998 71 256 29 05
TASHKENT_PORCELANOSA TASHKENT · +998 97 753 00 65

VIETNAM

HANOI_MILAN ARCHITECTURAL · 0913212568 0986110133
HANOI_MILAN ARCHITECTURAL · +84 8 5412 1819 +84 8 5412 1820
HANOI_MILAN HOME CENTER · 977800785 +84 4 3234 5028
HANOI_MILAN HOME CENTER DISTRIBUIDOR MR VU THAI · +84 9 1321 2568 +84 4 3234 5028
HO CHI MINH CITY_CASABELLA CO LTD · +84 9 1323 7771

YEMEN

SANAA_AL-YAMAMAH GROUP/ABO JALAL TAHER CORPORATION FOR GENERAL TRADE · +967 1 470 375 +967 1 405 665

YIBUTI

DJIBOUTI_AL-NEIMA IMMOBILIERE · 00253-21356659 00253-21356289



butech

PORCELANOSA Grupo

Professional book 2021

Design and photography: butech Marketing Department

Edited by: butech building technology, S.A.U.

Print: Jiménez Godoy, S.A. Artes Gráficas

butech building technology, S.A.U.

Ctra. Villarreal - Puebla de Arenoso
(CV-20) Km 2,5. Villarreal (Spain)

+34 964 53 62 00

butech@butech.es



www.butech.net

The contents of this catalog are protected by Intellectual Property Law, Royal Decree 1 / 1996. Any reproduction of it, in whole or in part, without the consent of PORCELANOSA Grupo is liable under the Penal Code.

